

INFORMATION TO USERS

This manuscript has been reproduced from the microfilm master. UMI films the text directly from the original or copy submitted. Thus, some thesis and dissertation copies are in typewriter face, while others may be from any type of computer printer.

The quality of this reproduction is dependent upon the quality of the copy submitted. Broken or indistinct print, colored or poor quality illustrations and photographs, print bleedthrough, substandard margins, and improper alignment can adversely affect reproduction.

In the unlikely event that the author did not send UMI a complete manuscript and there are missing pages, these will be noted. Also, if unauthorized copyright material had to be removed, a note will indicate the deletion.

Oversize materials (e.g., maps, drawings, charts) are reproduced by sectioning the original, beginning at the upper left-hand corner and continuing from left to right in equal sections with small overlaps. Each original is also photographed in one exposure and is included in reduced form at the back of the book.

Photographs included in the original manuscript have been reproduced xerographically in this copy. Higher quality 6" x 9" black and white photographic prints are available for any photographs or illustrations appearing in this copy for an additional charge. Contact UMI directly to order.

U·M·I

University Microfilms International
A Bell & Howell Information Company
300 North Zeeb Road, Ann Arbor, MI 48106-1346 USA
313/761-4700 800/521-0600

Order Number 9218154

**The mortuary behavior of Guanacaste/Nicoya: An analysis of
precolumbian social structure**

Hardy, Ellen Teresa, Ph.D.

University of California, Los Angeles, 1992

Copyright ©1992 by Hardy, Ellen Teresa. All rights reserved.

U·M·I
300 N. Zeeb Rd.
Ann Arbor, MI 48106

UNIVERSITY OF CALIFORNIA

Los Angeles

The Mortuary Behavior of Guanacaste/Nicoya: An Analysis of
Precolumbian Social Structure

A dissertation submitted in partial satisfaction of the
requirements for the degree Doctor of Philosophy in
Archaeology

by

Ellen Teresa Hardy

1992

© Copyright by
Ellen Teresa Hardy

1992

The dissertation of Ellen Teresa Hardy is approved.

James R. Sackett

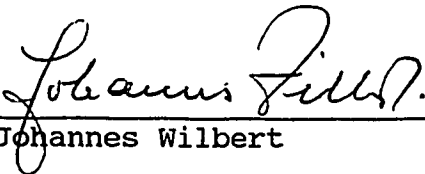
Johannes Wilbert

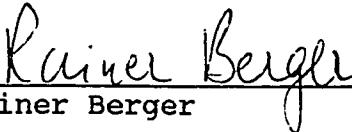
Rainer Berger

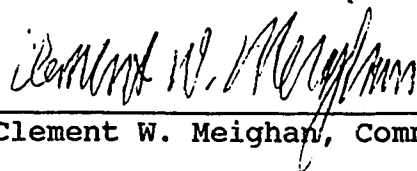
Clement W. Meighan, Committee Chair

University of California, Los Angeles

1992

For Clement W. Meighan

Table of Contents

Signature page	ii
Dedication	iii
Table of Contents	iv
List of Figures and Plates	vii
Acknowledgements	xii
Vita, Publications and Presentations	xvi
Abstract	xvii
Chapter 1 INTRODUCTION	1
Cultural Sequence	13
Geomorphological background	16
Natural Setting	19
The Nacascolo Site	23
Previous Archaeological Research in the Greater Nicoya Archaeological Subarea	26
History of Archaeological Investigations at Nacascolo	28
Areal and Cultural Definitions	40
Ethnohistoric/Ethnographic Background	48
Archaeologic Evidence of Foreign Influence or Migrations	53
Early Subsistence	62
Artifact Assemblages as Evidence of Subsistence	69
Social Organization	74
Chapter 2 PRECOLUMBIAN RELIGIOUS BELIEFS	80
Shamanic Origins	83
Shamanic Principles	84
Precolumbian Drug Use	87
Nagualism	90
Ritual Sacrifice	91
Human Sacrifice	93
Ritual Cannibalism	95
Archaeological Evidence of Human Sacrifice	98
Beliefs Regarding Human Sacrifice	102
Chorotega and Nicarao Mortuary Practices	104
Lowland Caribbean Mortuary Practices	105
Mortuary Practices of Talamancan Indians	106
Southern Concepts of the Realm of the Dead	112
Kogi Funerary Ritual	113
Maya Belief in the Afterlife	115

Chapter 3	METHODOLOGY AND DEFINITIONS	118
	Burial Definitions	123
	Statistical Analysis of Mortuary Data	129
	Excavation Procedure	131
	Cemetery Boundary Investigation	133
Chapter 4	Determining Factors of Skeletal Analyses	137
	Demography	142
	Burials	149
	Spatial Organization	151
	Secondary Burials and Mutilations	156
	Paleopathology	166
	Dating the Cemetery	173
	Additional Cultural Features and Mortuary Behavior	182
	Animal Ceremonialism	192
	Cultural Significance of Animal Ceremonialism and Archaeological Comparisons	195
	Dogs as Mortuary Offerings	196
	Other Animals Used in Ritual	201
	Archaeological Comparisons of Animal Ceremonialism	206
	Significance of Animal Ceremonialism	209
Chapter 5	Artifact Descriptions	211
	Ceramic Analysis	211
	Vessel Shape Descriptions	215
	Miniatures	218
	Zoned Bichrome Period Ceramics	219
	Monochromes	220
	Beige and Brown Wares	221
	Red Wares	224
	Red on Buff Wares	229
	Negative Resist	238
	Black on Red Wares	240
	Early Polychrome Period Ceramics	248
	Middle Polychrome Period Ceramics	255
	Late Polychrome Period Ceramics	257
	Ceramic Technology	256
	Additional Ceramic Artifacts	258
	Stone Artifact Assemblage	264
	Shell	276
	Bone	280
Chapter 6	Comparisons and Conclusions	283
	Nacacolo Mortuary Behavior	283
	Cultural Practices and Combination Burials	293
	Mourning Ceremonies	301
	Mortuary Symbolism, Iconography and Evidence of Subsistence Activities	301

Grave Offerings and Precolumbian Social Structure	314
Conclusions	324
Bibliography	329
Appendix I	360
Plates	407

4

LIST OF ILLUSTRATIONS

FIGURE	PAGE
1.1 Map of the Intermediate Area with Greater Nicoy inset and sites of the Southern Sector.	2
1.2 Map of the Greater Nicoya Archaeological Subarea.	8
1.3 Chronologic chart.	15
1.4 Nacascolo site map.	24
1.5 Nacascolo beach cemetery (Op.8A-M) excavation layout and stratigraphic profile.	37
1.6 Nacascolo beach cemetery (Op.8A-M) burial and feature locations.	In Pocket
4.1 Age categories and sub-group determinations.	140
4.2 Burial list OP.8A-M.	141
4.3 Age and sex distribution.	143
4.4 Mortality rates per age sub-group.	144
4.5 Demographic comparison of adults age categories and sub-groups.	145
4.6 Subadult mortality figures.	147
4.7 Comparison of Nacascolo and Vidor subadults.	148
4.8 List of secondary and disarticulated remains.	157
4.9 List of disarticulated remains Ft.18.	162
4.10 Radiocarbon dates from Nacascolo Op.8A-M.	176
4.11 Animal ceremonialism in Op.8A-M cemetery.	193
5.1 List of Artifact Assemblages.	211
6.1 Nacascolo beach cemetery burials and associated grave offerings.	
6.2 Iconography in artifact assemblages	305
6.3 Mora vessel rollout.	307
6.4 Papagayo vessel rollout.	308
6.5 List of Hierarchical levels.	320
PLATES	
1: Nacascolo site.	407
2: Nacascolo beach cemetery Op.8A-E.	408
3: Profile of "hueco grande" one of the excavations of Juan Dada. Types of stone referred to as " <u>mojones</u> ."	409
4: Combination burial excavated by Wallace and Accola.	410
5: Nacascolo Op.3a cist tomb.	411
6: Nacascolo house foundations of Op.37c.	412

7: <u>Huaquero</u> pit in beach cemetery.	413
8: Clearing brush from beach area in preparation for cemetery boundary test.	414
9: Calcareous concretions on Burial 105. Insets of root intrusion through Burials 82 and 87.	415
10: Nacascolo Op.8F, after a deluge.	416
11: Primary individuals placed on back in tightly flexed position:	417
12: Burials placed on back, legs flexed.	418
13: Individuals flexed on right side.	419
14: a) Semiflexed Burial 53, b) Burial 83, extended with legs tightly flexed.	420
15: Extended individuals.	421
16: Area of infant burials: Inverted urn Burial 48.	422
17: Urn Infant, Burial 49.	423
18: Group Burial 1, and Group Burial 4.	424
19: Group Burial 3, and Group Burial 2.	425
20: Group Burial 2: Burials 55, 56, 57, 58, 59.	426
21: Secondary Burial 60.	427
22: Area of infant burials found below mano (Art.170) and metate (Art.171) jade bead (Art. 168), and number of ceramic vessels.	428
23: Secondary burial from <u>Isla Venado</u> , <u>Sitio Regla</u>	429
24: Burial 14 cut by pit, Burial 26 extended individual in center, two disarticulated skulls. to his right (Burial 20,21), disarticulated long bones (Burial 6).	430
25: Tightly flexed, young adult, with cranium missing	431
26: Burial 28 tightly flexed, middle adult, female, missing left hand.d.	432

27: Evidence of mutilation and/or sacrifice.	433
28: Top of Feature 18, area of secondary remains.	434
29: Feature 18, secondary bone groups.	435
30: Bone groups "E" "F" and "G" of Feature 18; semiarticulated remains and Burial 102.	436
31: Drawing and photograph of bone groups of Ft.18; Burial 101 and bone groups "J" and "M"	437
32: Paleopathology of burials Op.8A-M.	438
33: Anomalies of skeletal remains.	439
34: Possible treponema, Burial 82,	440
35: Possible treponema, Burial 82	441
36: Possible treponema, Burial 82	442
37: Shell and sherd burial pit fill, Burial 85.	443
38: Op.8A-E, Feature 1.	444
39: Burial 34.	445
40: Excavation of Feature 13 ovens.	446
41: Oven of 8H (Feature 1, 1981).	447
42: Several types of ovens found around Nacascolo.	448
43: Burial 108, below ovens of Feature 13, and stone	449
44: Shell (<u>Ostrea</u>) floor, Burial 105 on top.	450
45: Animal ceremonialism expressed in Nacascolo beach cemetery (Op.8A-M).	451
46: Concentration of burned <u>Strombus</u>	452
47: Vessel shapes, large vessels	453
48: Miniature vessels.	454
49 a) Espejo Black; b) Ampompua Modelled	455
50 a) unknown type, crude ware; b) Yayal Brown	456

51 a) unknown type, almost purple with incised cross; b) c,d, e all Juanilla Red on Beige	457
52 Piches Red zoomorph vessel, Fregitidae, Art. 5.	458
53: Piches Red zoomorph vessel <u>Lenguado</u> (Bothidae).	459
54: Three types of Los Hermanos Beige vessels.	460
55: Los Hermanos Beige ollas, plate, and incensario.	461
56: Negative resist technique, black on red ware vessels.	462
57: Negative resist technique, white on red ware.	463
58: Charco Red on Black Ware vessel Var. Puerto.	464
59: Art.287 Charco: Puerto variety and possibly Cabuyal mix vessel.	465
60: Tola Trichrome vessels.	466
61: A) Tola effigy vessel, <u>Crax rubra</u> . B) Carrillo effigy vessel, bird.	467
62) Zelaya Trichrome cuspidor vessel.	468
63: Guinea Incised vessels with iconographic elements.	469
64: Carrillo vessels.	470
65: A) Galo vessel (Art.196a) associated with infant Burial 72. B) Chavez Red on Beige vessel placed inside above Galo vessel.	471
66: Chavez White on Red effigy support. Art.13, identified as an owl (Tytonidae).	472
67: A) Cabuyal vessel. B) Potosi Applique	473
68: Mora vessel (Art.35), associated with Burial 9.	474
69: Papagayo vessel (Art.113) associated with Burial 36.	475
70: A) Mora spindle whorl, Art.38, B) Jicote Polychrome, C) Luna ware sherd.	476
71: Ceramic cones associated with Burial 31	477
72: Grave offerings associated with Burial 31.	478

73: Some representative stone tools of Nacascolo beach cemetery.	479
74: Plain tripod metates from beach cemetery.	480
75: Low relief carved, special purpose metates..	481
76: Comparison of low relief carved metates.	482
77: "Celts" of Nacascolo beach cemetery.	483
78: Pestles type 2 and 3.	484
79: Hammerstones	485
80: Abraders or whetstones. Enigmatic stone.	486
81: Small stones, some "nutting" some enigmatic.	487
82: Tubular jade (greenstone) bead (Art.167). Jade pendant	488
83: <u>Strombus</u> flange and columella tools.	489
84: Tools made of <u>Ficus ventricosa</u> ; Modified <u>Ostrea</u> .	490
85: Modified fossilized shell, (Art.305); Modified shell associated with Feature 18	491
86 Bone artifact assemblage	492
87 Iconographic elements on ceramics	493
88 Cist tombs from Guayabo de Turrialba	494
89 Elite burial from Barrial de Heredia, Central Valley.	495
90 Cist tombs from Cartago and Atlantic watershed	496

The following graciously lent their photographs:
 Brian Dillon Plates 1b, 2, 3a, 11a, 12a, 18a, 24, 26, 38;
 Maritza Gutierrez Plates 6, 89, 90; Henry Wallace
 (courtesy of University of New Mexico Press) Plate 4;
 All other photographs are by Ellen Hardy.

ACKNOWLEDGMENTS

As I near the end of my graduate career, I suppose I have the same thoughts and sentiments most have under similar circumstances. There are exhilarating feelings, as I imagine getting out of here; yet, of course, I possess full-throttle panic as I must finish this post haste, print the last two chapters, finish labeling the plates, photocopy the whole thing...well you get the idea. I then drive to L.A. for my appointment with destiny. I've barely timed it correctly. However, I can't let anymore time pass without acknowledging the help I've received along this arduous road. First to my Committee members Clement Meighan, James Sackett, Rainer Berger, Johannes Wilbert, and even James Lockhart, who signed off at my orals (and enabled me exultantly, to pretend I had his signature); one down and four to go. I thank my Committee for sharing their extensive knowledge and experience, and leading me through the labyrinthine academe-turnstyle. Helle Girey, Archaeology Dept. Graduate Advisor, offered consistent patience and understanding.

Over my career I've developed wonderful relationships with personnel of the Museo Nacional de Costa Rica, and I have benefitted from their dedicated assistance. I thank Juan Vicente Guerrero and Sylvia Salgado for their judgement

and thought provoking discussions on all topics, and aid in ceramic identification. Claude Baudez provided a quick evaluation of the ceramics after my '88-89 field season. Eduardo Odio Orozco identified taxa of iconographic elements on vessels and metates. Marlynn Beaudry also helped me with this task. Cesar Laurito M., geologist, identified material of stone tools and shells. Cesar also assisted me in excavations at Nacascolo. Elisenda Coladan provided needed assistance in stone tool identification. The Patrulera Costarricense graciously transported all field equipment and archaeological collections from Nacascolo to Playa Panama, where Frederico Solanos was awaiting inevitably to carry everything back to the MNCR. Frederico also generously shared his office, while I worked in the Museum. I thank others in the MNCR for their comradery and data sharing, particularly Wilson Valerio V., Francisco Corrales U., Myrna Rojas, and especially, Ricardo Vazquez Leiva and Maritza Gutierrez Gonzalez Duncan Davis, for their unfailing assistance in analyzing human skeletal and faunal remains; more than this, I am moved to acknowledge their friendship, freely given, an altogether priceless commodity. Maritza has allowed me to reproduce her photographs of the Nacascolo house foundations (Plate 6) and cist tomb from Ledesma Severo; and Ricardo has also given permission to use the photo of the cist tombs from Cartago. I thank Andrew

Nelson for his help in editing the paleopathology section. Tim Seymour for greatly enhancing my graphics. I am indebted to the United States Information Services and the Fulbright people, for their research grant which enabled me to go to Costa Rica, and to conduct my research. I thank Sally Evans, of Grants and Scholarships, who helped with the Fulbright application, and always, remarkably, treated me as though I deserved it. The University of New Mexico has granted permission to reproduce Henry Wallace's photograph of the Nacascolo combination burial (Plate 4).

I thank all those who have shared field experiences, particularly John Verano (see the cat? see the cradle?) and Bob Rechtman (you still take good notes). My appreciation also goes to Rebecca Gonzalez L., even if you did file before me! I thank Brian Dillon for providing my first research opportunity, and for continuing to be supportive of my career. Brian has generously allowed me to use some of this photographs (Plates 1b,2,3a,11a,12a,18a,24,26,38). John Lawrence participated in field work in 1980, and has always openly discussed his data and opinions regarding Costa Rican archaeology. Additional colleagues, who have discussed aspects of my work, include Fred Lange, John Hoopes, Richard Cooke, and Michael Snarskis.

I am especially indebted to my parents, Jim and Henrietta

Hardy, who have supported me financially and emotionally, and who have learned to ignore my occasional eccentric outbursts over power failures, computer mishaps, and somnambulist states. They finally, mercifully, stopped asking me, "Have you finished?"...Mom, Dad, it's done; you can even have the dinning room table back now. I thank my brothers and sisters for their...inspiration. My brother Jake helped edit the more clumsey parts; my sister Cindy went above and beyond....And to my friends, I render thanks for their unstinting encouragement and support- especially to Richard Galin, Rita Shepard, Ross Sackett and Frank Butler. To all, my heartfelt thanks, gratitude, and affection (con todo carino y corazon)! Honestly, I would not be writing this today, if it were not for my incomparable mentor, Clement W. Meighan, and for his ceaseless encouragement, unfailing support, gratifying good humor, affection and inspiration, to you Clem, I dedicate this dissertation.

VITA

- November 23, 1954 Born, Los Angeles, California
- July-Sept. 1980 Field Work, UCLA/Museo Nacional de
Costa Rica, Proyecto Bahia Culebra
- 1981 B.A., Anthropology
University of California,
Los Angeles (UCLA)
- June-Sept. 1981 Field Work, Costa Rica
UCLA Culebra Bay Project
- 1983 Teaching Assistant, Archaeology
Field, UCLA
- March-June, 1982 Field Work, International Joint
Expedition to Terqa, Ashara, Syria
- 1983 M.A., Archaeology
UCLA
- 1987-1989 Fulbright Researcher, Costa Rica

PUBLICATIONS AND PRESENTATIONS

- Lawrence, John and Ellen T. Hardy
- 1982 Excavation of an Early Polychrome Tomb at
Nacascolo. Manuscript on file Museo Nacional de
Costa Rica, San Jose.
- 1986 The Religious Implications of the Material Remains
from San Clemente Island, California. Paper
presented at the 51st Annual Meeting of the Society
for American Archaeology, New Orleans, Louisiana.
- 1990 Mortuary Practices and Social Structure Among
Precolumbian Inhabitants of the Bay of Culebra,
Costa Rica. Paper presented at the 55th Annual
Meeting of the Society for American Archaeology,
Las Vegas, Nevada. General Session Chair:
Contributions to Mesoamerican Archaeology.
- In Religious Aspects of the Material Remains from San
Press Clemente Island. In Archaeological Investigations
from San Clemente Island, California. Meighan,
ed., University of California, Los Angeles.

ABSTRACT OF THE DISSERTATION

The Mortuary Behavior of Guanacaste/Nicoya: An Analysis of
Precolumbian Social Structure

by

Ellen Teresa Hardy

Doctor of Philosophy in Archaeology

University of California, Los Angeles, 1992

Professor Clement W. Meighan, Chair

This study analyzed mortuary data from the oldest and one of the largest precolumbian cemeteries in Costa Rica. Nacascolo is a multicomponent site with mortuary evidence covering roughly 2000 years (600 B. C. -A.D. 1400). The archaeological data were compared with ethnohistoric, ethnographic, and established beliefs concerning regional archaeological syntheses and mortuary practices. These were found to be informative, yet not always accurate. Mortuary evidence informs directly on health conditions, diet, disease, demography, and indirectly on social and ideological facets of culture. Information derived from mortuary remains gleans aspects of social structure and

complexity. Based on differential mortuary practices, a method was developed that allow a measuring of social structure of Precolumbian Indian groups. It allows comparisons of these social groups within the larger region.

This analysis has identified gender-sensitive artifacts, yet, at the same time, has demonstrated the danger in placing too much emphasis on these grave offerings, in presuming sex, when skeletal remains have not been preserved. Age and sex criteria cross-cut all burial positions and types of grave offerings. Analysis indicates differential mortuary treatment from early times. Based on this analysis of differential mortuary practices, a hierarchical social structure was hypothesized, that demonstrated a classic pyramidal structure with the majority of persons at the lower end and relatively few individuals at the highest levels. It demonstrates a social complexity of ascribed social status based on birth and access to restricted resources.

This study has provided evidence of ritual activities, and has analyzed aspects of culture so difficult to attain archaeologically. Knowledge derived from this analysis enlightens an understanding of precolumbian religious beliefs, including information on ritual behavior, and

cultural practices of sacrifice, mutilation, and animal ceremonialism. Through this analysis of mortuary behavior, we acquire knowledge of prehispanic peoples, who left no written history, and confirm statements in the histories of those who did.

Chapter 1

INTRODUCTION

The primary goal of this dissertation is to reconstruct the precolumbian socioeconomic structure for Guanacaste/Nicoya, Costa Rica (Figure 1.1). Based on comparative analysis of mortuary practices within the various ecological zones, an attempt is made to elucidate problems of culture process by inferring aspects of prehistoric social structure. It has been demonstrated (Binford 1971, Brown 1971, Saxe 1970, Peebles 1974, and Tainter 1975) that mortuary data may be particularly suited to solve these problems. Therefore, this study emphasizes mortuary practices, their archaeological correlates, and the resulting social significance of variability in these practices.

Mortuary evidence is one of the most valuable types of archaeological data because it accurately reconstructs human detail. It therefore informs directly on diet, demography, disease, health conditions and, indirectly, quite tellingly on social and ideological aspects of human societies (Turner 1986; Buikstra and Gordon 1981; Meighan 1984; Ubelaker and Grant 1989). This evidence, then, is vital in acquiring knowledge of extinct societies whose

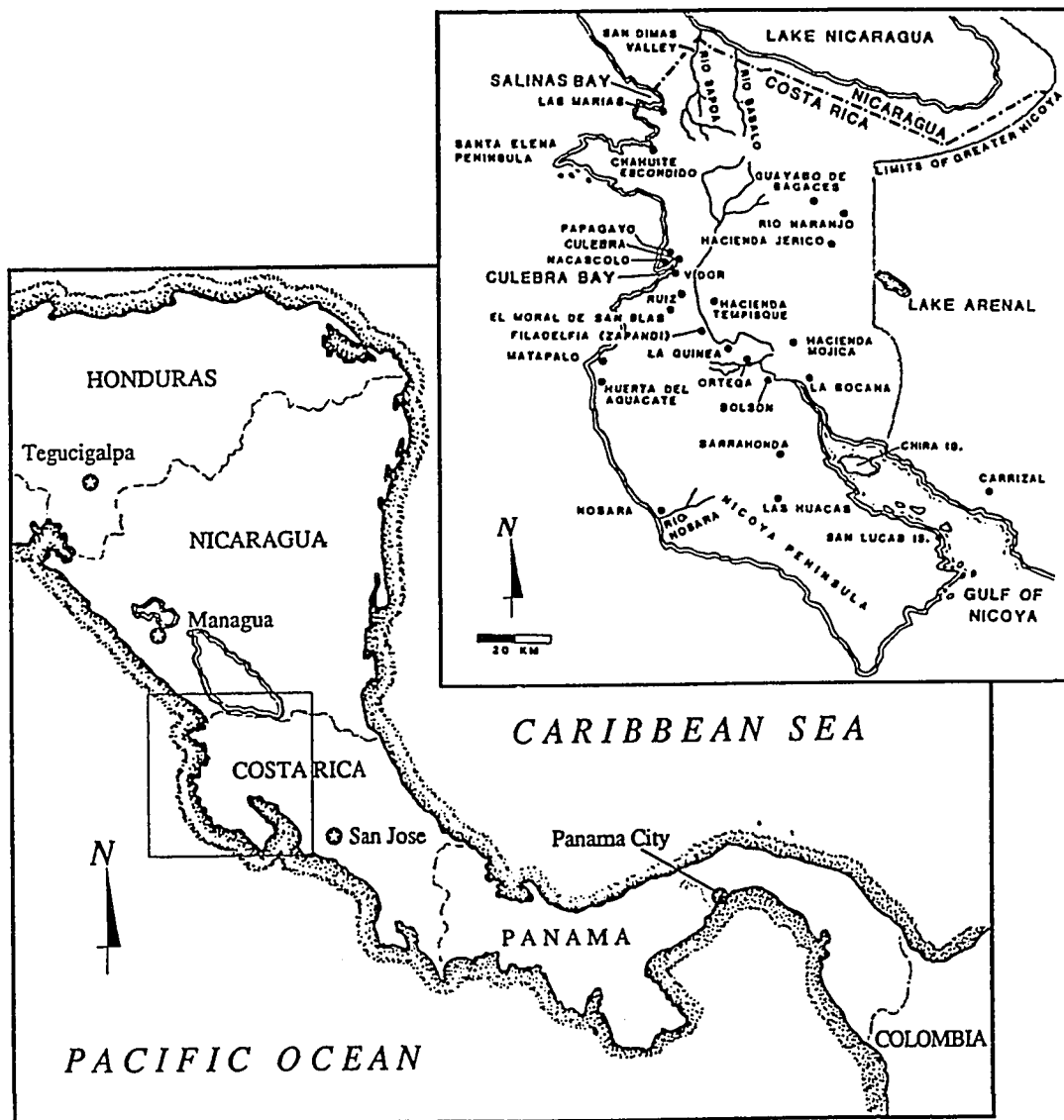

Fig. 1.1 Map of the Intermediate Area with inset of the Greater Nicoya and sites considered in this study.

archaeological remains are the only evidence of their existence; it provides a history.

The purpose of this study is to discover the relationships between differential mortuary treatment and social organization. It stems from a basic assumption that a range of statuses is represented by burial data (Saxe 1970). This is not necessarily an attempt to identify the richest individuals in any given cemetery, although this is inevitable in the course of this study. Rather, this is an attempt to identify and separate consistent classes of burials within cemeteries, or sets of cemeteries within the region. Their full significance must necessarily emerge with time.

In particular, this study isolates burials based on energy expenditure. Wire (1972) in western Mesoamerica, and later Tainter (1975), established that vertical differentiation in social systems is reflected archaeologically by variations in the amount of energy expended in mortuary ritual; the energy expended in mortuary ceremonies should be reflected in grave size and elaborateness of the interment, method of handling and corpse disposal, and grave goods. This study considers social structure in a manner which allows comparative study of variation and change.

This examination attempts to answer the following questions: What is the relationship between differential mortuary behavior and precolumbian social organization of Guanacaste-Nicoya? If there is change in mortuary behavior over time and/or space does this suggest increased social complexity, stress, or perhaps boundaries and ethnicity? How does this serve to reinforce group solidarity? In terms of energy expenditure, is this complexity measurable? If so, will this adequately isolate burial sets? Under what particular conditions does complexity increase? What statuses are reflected in variability? What was the role of the dead among the living?

I analyze mortuary practices from the Greater Nicoya Archaeological Subarea (Norweb 1961:551) emphasizing the southern sector (inset Figure 1.1). The central focus is the Nacascolo site, Culebra Bay, and data collected by archaeologists, myself included, from UCLA and the Museo Nacional de Costa Rica (MNCR) in 1980, 1981, and 1988-89 (Plate 1). Nacascolo is a multi-component site, occupied continuously from the middle of the Zoned Bichrome Period (approximately 500 B.C.) until just before the arrival of the Spaniards (@ A.D. 1520). Throughout the site mortuary evidence may be found reflecting this entire time span. The evidence regarding overall site mortuary behavior 13

suggests increasing social stratification and burial complexity over time.

High status individuals were provided prestigious burial areas along the mountain slopes and inland valley areas. A major cemetery, located on the inland beach zone, reflects occupation from Zoned Bichrome (500 B.C.) through Middle Polychrome periods, and also exhibits some Late Polychrome Period components. It was possibly the burial ground of the common people. It is the oldest precolumbian cemetery excavated along the Pacific coast of Costa Rica, and the first identified on a sand spit of Culebra Bay. The remains of approximately 120 individuals and associated grave offerings have been excavated (Plate 2). This is the oldest, one of the largest, and best preserved precolumbian skeletal series for all of Costa Rica, and one of the few cemeteries with evidence for use throughout the entire occupation of the site.

A major problem, in an investigation such as this, is to get an adequate representation of reality, or, ascertaining to what degree the archaeological remains are representative of the precolumbian society responsible for them. In light of the data derived from the Nacascolo beach cemetery, I am able to assume the excavated sample is representative. This is because individuals of all age

groups and an approximate 50:50 female:male ratio is found among identifiable adults; in terms of energy expenditure, I assume greater complexity exists that has not been sampled.

Other problems to be consistently considered here are dating the cemeteries to observe culture change, and determining patterning of certain products among individuals and cemeteries to aid the identification of intrusive and/or high prestige artifacts. This is also the case as regards status and sex indicators.

Since change in the archaeological record often reflects temporal divisions, an analysis of burial practices over the time span indicated provides an excellent criterion for identifying and substantiating culture change. This analysis will not only shed light on these changes, enhancing understanding of precolumbian societies, but through their study, knowledge is acquired of the culture history of unknown peoples, whose only evidence of their existence resides in the archaeological record.

Additional data are derived from unpublished site reports, excavation reports, field notes, artifact lists, "Preliminary Reports", "Weekly Reports" and skeletal

analyses archived in the Museo Nacional de Costa Rica, and published areal syntheses; from ethnohistoric and ethnographic sources for the Chorotega and Nicarao, Talamancan Indians, Cuna Indians of Panama, and Kogi of Columbia (Chibchan tribes related to those who migrated in millennia past most likely shared similar degrees of social complexity and shamanic beliefs), and to the north, Maya sources are consulted. There are established ceramic chronologies (Coe and Baudez 1961; Norweb 1961,1964; Baudez 1967; Sweeney 1975; Accola 1978; Healy 1980; Lange and Abel-Vidor 1980; Lange et al 1984), for the Greater Nicoya Archaeological Subarea (Figure 1.2).

One result of this study and the data analyzed, is the unexpected discrepancy between archaeological data and accepted opinions regarding regional mortuary practices. To resolve this problem I attempt to sort fact from fiction; in archaeological terms, I state evidence which supports or negates established theories or espoused opinions concerning mortuary practices, and demonstrate the usefulness of mortuary data in ascertaining more accurate aspects of social organization, religious beliefs, and subsistence.

In all honesty, during the course of this study of precolumbian mortuary practices for the Greater Nicoya

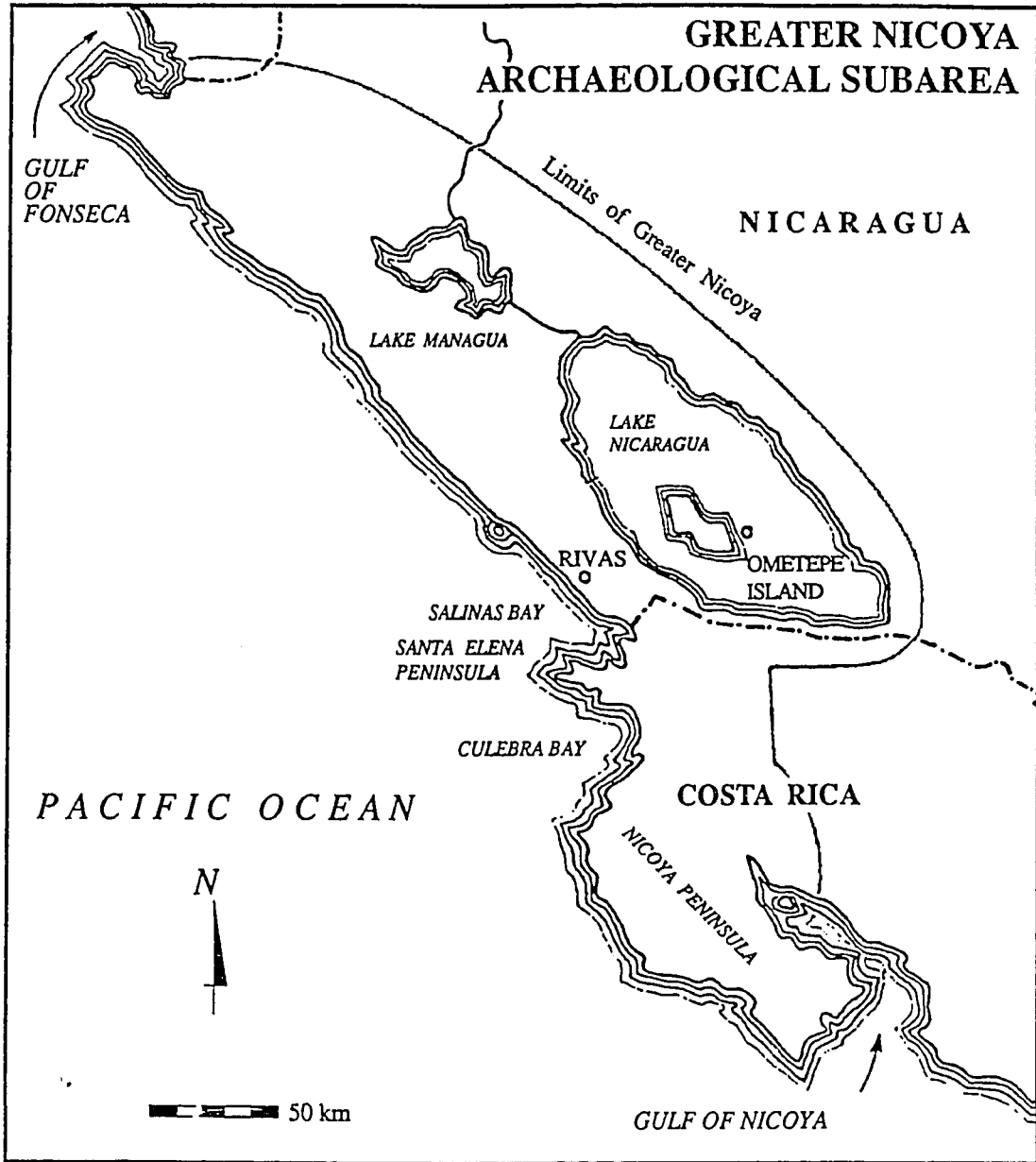

Fig. 1.2

Archaeological Subarea, I have become dismayed by the tendency of investigators to attribute particular mortuary customs to given areas or groups based on indiscriminate use of ethnographic accounts, or based on the ideas expressed in regional syntheses which are not always supported by archaeologic data, yet continue to be cited in subsequent publications. Over time, some of these opinions have taken on a seeming factual quality upheld only by the failure of investigators to adequately research the original source and critically evaluate the data upon which the statements were made. Archaeologists with differing objectives, excavation methods, and record keeping systems, plus failure to define terms, make comparative analyses difficult other than to say that a particular burial practice existed or a particular artifact was found. I have encountered descriptions pertaining to burial position such as "extended" or "legs flexed under body" and even "not recorded," often contradictory and largely useless when making comparisons, and any type of comparative statistical analysis impossible. Despite these shortcomings, these reports are often useful in relating general burial types and mortuary behavior. A major problem developed, however, when I tried to compare my mortuary data to established regional and cultural syntheses. For example, I read that cremation and interment of the ashes was common, although

not universal, among the Mexicans, except the Zapotecs, and among the Mayas. The interment of bones not burned or of a complete body in an urn, is a South-American custom; it appears on that continent from Venezuela to Argentina (Lothrop 1926:93).

"Burial methods in the Pacific coast of Costa Rica and Nicaragua include the use of urns, cremation, and inhumation...Both articulated and disarticulated bodies occur in urns as well as the ashes of cremated bodies...Inhumation, often in mounds was practiced in all parts of the Nicaragua region and was almost universal in Nicoya" (Strong 1948:124).

Strong noted that osseous preservation "is very bad, but where determination is possible secondary or bundle burials seem most common" (Strong 1948:124).

Stone (1948:174-175) reaffirms cremation is "most typical" of the different kinds of burial in Costa Rica, the ashes being placed in an urn. One also gets the impression all urns are inverted, particularly those of infants. This will be shown not to be the case.

Certainly cremation is well documented in ethnohistoric sources for Central and Southern Costa Rica, In light of this fact, I wondered why, if cremation is indeed as widespread a practice as the literature suggests, do I find so little archaeological evidence of cremation in the southern sector of Greater Nicoya? No

doubt osseous preservation is a factor but to what degree? Of 162 urn burials found by Bransford at Ometepec (today called Ometepe), only two urns contained remains which evidenced having been burned; they are described as Jar XXVIII, an oblong urn, contained "a few blackened bones", and jar XXIX, a round urn, contained "piece burnt bone, painted plate" (Bransford 1881:16). Faulwell (1970:18) reports one partially burned metacarpal found among secondary remains at Las Marias. At the Vidor cemetery, located across the bay from Nacascolo, where preservation of infants placed in urns was so good "some still had fingernails" (Vazquez, personal communication), of the 192 excavated burials none evidenced having been burned; despite the fact that some of the remains were found between layers of ash, cremation is not proposed. However, one burial urn containing the cremated remains of an adult male has been found eroding out of a river drainage at the site of El Rincon de Mama Inez, part of Hacienda Los Inocentes, not far from the Nicaraguan border (Chamberlain 1991).

This recent find provides evidence for cremation in northern Costa Rica; but it is the first unequivocal evidence of this kind. It adds fuel to a growing controversy: I will address it more thoroughly in the Comparisons section. For now, we must simply note it, as

it is important to record the uncertainty of some of the literature, not to mention actual potential inaccuracies of supposition of cremation in northwestern Costa Rica.

How then does this belief in cremation persist so tenaciously in the literature (Stone 1977:90; Lange 1984:190). It is apparent that ethnohistoric and ethnographic sources (particularly those for Talamancan Indians) have greatly influenced cultural syntheses. Lothrop (citing Oviedo?) states that the high class practices cremation and burial of the ashes (1926:93). It is possible he was also aware of Cockburn's 1735 account of a cremation among "Indios Bravos" at "Los Capeces" (Cockburn 1962:28). Cabria thinks this occurs in the land of the Quepos Indians (Melendez 1962:30), and Termer (1962:87) locates Capeces near Quepos and identifies these people as members of the Quepos tribe or Boruca Indians. But, technically, these are outside Greater Nicoya. Whether or not Lothrop knew of Cockburn's account, Stone (1977:90) certainly cites him. It is apparent that the "evidence" for cremation as a widespread mortuary practice is derived from these historical sources and rather casual references, and should not be used indiscriminately in ascribing cultural practices to dimly perceived neighboring groups or archaeological cultures.

Comparable generalizations concerning mortuary behavior and other critical aspects of precolumbian society most likely pervade the archaeological literature, and have woven a fine web of deception, confusing to those who deal with seemingly contradictory data yet comforting to those with less empirical natures or who have not experienced actual first hand information, nor conflicting world views due to their tunnel vision. There is also a tendency to cite apparently sacrosanct but outdated, and even inaccurate sources. I hope to avoid this pit and ignore others' generalizations, so pervasive in the literature, which are unintentional but simply unsupported by the evidence.

Since mortuary data warrant comparisons to the ethnographic and archaeological literature to the north and south of the study area, I am in a position to evaluate these sources, as I attempt to explain the cultural-historical significance of the data. However, other data concerning subsistence and settlement, which my data do not directly address, are more difficult to assess.

Cultural Sequence

The archaic tradition (Periods I,II,III: ?-1000

B.C.; Figure 1.3) is sparsely represented in Costa Rica. This is most likely due to volcanic activity, which has buried this evidence below meters of alluvium, the nomadic nature of early cultures, and, admittedly, poor preservation. The earliest evidence of hunter-gatherers in Guanacaste-Nicoya, is a single fluted point found in a box from Hartman's 1903 excavations, which was not identified until 50 years later (Swauger and Meyer-Oakes 1952). Since virtually no additional evidence of these early times are evidenced in the study area, discussion of this time period necessarily ends and focuses on the formative cultures evidenced by 1000 B.C.. The temporal sequences are based primarily on changing ceramic styles, and chronologies developed by Coe and Baudez (1962), Baudez (1967), Lange (1971a), Sweeney (1975), Healy (1980), Accola (1978), Lange and Abel-Vidor (1980), and Lange et al (1984). This will not be discussed here but may be found in Chapter 5. Cultural features pertinent to each temporal period, however, are consistently discussed with respect to the general subject matter.

Before presenting ethnohistoric data for these societies, I set the scene with general geomorphological and cultural backgrounds, allowing insight into the interactions of the culture within its environment. Only after this socio-cultural-ecological complex has been

YEARS	CENTRAL AMERICAN PERIODIZATION	REGIONAL PERIODS	ARCHAEOLOGICAL PHASES					
			RIVAS	SANTA ELENA PENINSULA	CULEBRA BAY	TEMPISQUE VALLEY	TAMARINDO BAY	
1550	PERIOD VI	LATE POLYCHROME	ALTA GRACIA	LA CRUZ A	RUIZ	BEBEDERO B		
1500								
1400			MIDDLE POLYCHROME	LAS LAJAS	LA CRUZ B	IGUANITA	BEBEDERO A	
1300								
1200								
1100				LA VIRGEN		MONTE DEL BARCO	PALO BLANCO B	TAMARINDO B
1000	PERIOD V	EARLY POLYCHROME	APOMPUA	DOSCIENTOS	PANAMA	PALO BLANCO A	TAMARINDO A	
900								
800								
700				PALOS NEGROS	SANTA ELENA	CULEBRA	SAN BOSCO	HATAPALO
600	PERIOD IV	LINEAR DECORATED	SAN ROQUE	MURCIELAGOS	MATA DE UVA	CIRUELAS	LAS MINAS	
500								
400		ZONED BICHROME	SAN JORGE		CHOMBO	ORSO	CATALINA	MONTE FRESCO
300								
200				AVILES				
100 AD								
0								
100 BC								
200					LOMA B			
300								
400								
500								
600								
700								
800								
900								
1000								

Fig. 1.3 Chronologic chart of Greater Nicoya

elucidated, can behavior and variability be understood.

This is particularly true when regarding mortuary practices.

"Burial data can only be understood in terms of the organizational properties of the cultural systems themselves" (Binford 1972:239).

With this in mind, attention now focuses on the environment which in Steward's (1955:36) sense "both limits and permits distinctive modes of life" , and provides the impetus for prehistoric settlements and their associated cemeteries at Nacascolo.

Geomorphological Background

Costa Rica is located between $8^{\circ} 2'$ and $11^{\circ} 13'$ north latitude and $85^{\circ} 58'$ longitude from Greenwich Meridian (Vincenzi 1936), and is situated between Nicaragua to the north and Panama to the south. It is bounded on the west by the Pacific Ocean, and on the northeast by the Caribbean Sea (Figure 1.1). From a geologic point of view Costa Rica is young. Mountains stretch from the northeast to the southwest forming part of the great cordillera that crosses all of the American continent. Running down the Cordillera are volcanos. Four of the largest volcanos are located in the northern part within 30-40 kilometers to

the east of Culebra Bay, one of the two bays of northwestern Costa Rica, in a region known as the "volcanic lowlands of Central America" (West 1964). Volcanic activity has played a major role in the geomorphological growth of the area, and has been responsible for cultural developments as well. Indeed, the presence of ash levels in excavations are recorded throughout the Arenal area and Guanacaste (Sheets 1984) and indicate that the area has twice been blanketed by ash falls during its prehistoric human occupation (Lange 1978:298; Sheets 1984); these ash levels are evidenced at the Vidor site, located across the bay from Nacascolo, but no ash levels have not been reported for Nacascolo. To what degree this activity has affected precolumbian adaptation has been addressed by Sheets (1984).

Northwestern Costa Rica consists of high coasts with an extremely irregular coastline, peninsulas, deep and sheltered bays, offshore islands, and occasional stretches of low coastal plain (West 1964). The irregular and mountainous character is associated with active faulting, plate tectonics, the recent rise of sea level, and vulcanism (West 1964). The two large peninsulas Nicoya and Ocos are seen as products of a NW-SE fault system that has separated the old granite rocks of the peninsula from the young volcanics and sedimentations of the interior.

The Nacascolo peninsula and the area around Culebra Bay are composed of volcanic rock, mainly ignimbrites; yet, this area lacks accessible sources of basalt and andesites, vital to hard-stone toolmaking, and a factor which implies importation of raw materials or finished tools into Nacascolo. To the east, throughout Guanacaste, lie consolidated Pleistocene alluvial sediments, hilly igneous and metamorphic regions, low lying ash plains, and volcanos (Wagner 1958:195). Valleys around Culebra Bay, such as Nacascolo, witnessed their major periods of filling and soil formation during early and middle Quarternary times (Dengo 1962). The gradual silting in of bays is often responsible for burying cultural material meters beneath its alluvium and may be responsible for the lack of shell mounds throughout Costa Rica before the Early Polychrome Period; shell mounds may be buried, or, perhaps displaced from immediate marine environment and found further inland. Furthermore, as alluvium builds, the water table rises. The rising water table at Nacascolo is responsible for calcareous deposits found on many beach cemetery skeletons and artifacts.

Only two major river drainages are found in Greater Nicoya. The Esterio Real drains western Nicaragua into the Bay of Fonseca, and the Tempisque River drains the Guanacaste Plains and Nicoya Peninsula into the Gulf of

Nicoya. The partially navigatable Tempisque River, separating the Nicoya Peninsula from the rest of the province, has played an important role in the cultural development of Guanacaste/Nicoya both as a migration-trade route, as well as serving as a frontier between ethnic groups (Baudez 1967).

Guanacaste soils are "internally weathered and subject to intermittent leaching" (Stevens 1964:309), yet they are productive because the basic mineral nutrients come from rich parent material (Stevens 1964:311). There are however, "pockets" of low fertility such as the Santa Elena peninsula (Lange 1976), as well as Lawrence's (1989) palnological study indicating a fertile Nacascolo valley.

Natural Setting

The climate of coastal Guanacaste follows a "tropical wet and dry" regime and receives between 1000 and 2000 millimeters of rain annually, making the area much drier than the Atlantic slope and Central Highlands of Costa Rica (Vivo-Escoto 1964). The natural vegetation of the Nacascolo peninsula shares characteristics typical of tropical or scrub forests, with deciduous trees and shrubs growing wildly during the rainy season, obscuring the archaeologists vision of cultural features and impeding

travel. The tallest forest growth naturally occurs in the wetter, more protected valleys, except where the salt/fresh water estuaries encourage the growth of red and black mangrove (Rhizophora) swamps. Around the site are guanacaste (Enterolobium cyclocarpum), cenizaro (Pithecellobium saman), and guapinol (Hymenea courbaril) trees. Saguaro family cactus and agave-like cactus occupy the driest and rockiest areas along the shoreline cliffs. An excellent source for species accounts has been provided by Janzen (1983).

Within this region then, typical terrestrial fauna include tapirs (Tapirus bairdii) coati (Nasua narica), peccary (Tayassu tajacu, Tayassu peccari), opossum (Coendou sp.) and porcupines (Coendou mexicanum), armadillo (Dasypus novemcinctus), tepizcuintle (Agouti paca virgatus), squirrels (Scuridae), rats (Rattus sp.), howler (Alouatta palliata) and spider (Ateles geoffroyi) monkeys, coyotes (Canis latrans), and the grey fox (Urocyon cinereoargenteus). Game birds include currasow (Crax rubra), guaves (Herpetotheres cachinnas), chachalacas (Ortalis sp.), parrots (Psittiacidae), pelicans (Pelicanidae), frigatebirds (Fregata magnificens), and finches. Several species of bats including vampire (Desmodus rotundus) are very common. Common reptiles include arboreal iguanas (Iguana iguana,

Ctenosaura similis, Basiliscus basiliscus), lizards (Teiidae), frogs (Anura), both venomous and nonvenomous toads (Bufonidae), and a number of snakes including rattlesnake (Crotalus durissus) and the greatly feared fer de lance (Bothrops asper) are abundant.

In the swamp zones the digging actions of land crabs (Geocarinus sp.) upset archaeological deposits. At night, hermit crabs cover the intertidal zone. Scorpions and stinging spiders are common in the drier parts of the valleys and plateaus, as are mosquitos and biting flies in the wetter areas. Furthermore, the area supports a wide variety of tropical insects, too numerous to list in this paper.

The marine life of the Culebra Bay likewise provides diverse resources, undoubtedly exploited by the prehispanic populations. Dozens of different types of mollusks and other large marine shells are found around the bay. The mangrove swamps also host specially adapted shellfish. Other marine inhabitants include tuna, rays, flying fish, dolphins, and sea turtles (Cheloniidae). According to Hubbs and Roden (1964), the rich marine resources are products of upwelling ocean currents induced by the off-shore winds of the dry season. The cold water brings more plankton which attract and nourish marine

fauna in large numbers. This condition goes back at least 8000 years (Lange 1978). Modern fishing technology consists of nets and lines from small boats as well as free diving for shellfish and crustaceans. While present day observation makes these resources appear rich and plentiful, this is misleading; shorelines are unstable and the availability of various resources fluctuate in long and short term cycles (Lange 1978:103). Indeed, the deceptive present day topographical conditions most likely do not reflect prehistoric conditions, but rather reflect changes resulting from modern practices of deforestation and overexploitation of the natural resources, and cattle ranging (Sweeney 1975; personal observation). Pallant (1981) hypothesized that precolumbian land clearing practices at Nacascolo were responsible for estuary siltation and subsequent change in depositional environments (moist to dry). Together with land-clearing practices, both processes would have contributed to the current stratification of soil environments (Lawrence:1989:83). Forest vegetation was probably being cleared from the lower valley from a very early date (Lawrence 1989:73). Lawrence does not know if this was for food production or habitations, but household refuse is found more than 200 meters from his testing site.

Plate tectonic movement, particularly the Nicoya

plate, has raised the Guanacaste coast during the period of human occupation (Frazier 1970 in Lange 1978), and this uplift, according to Lange, with related settling of coastal sedimentary pockets, would have significant impact on the presence or absence of mangrove swamps and other productive zones, such as those found around Culebra Bay (Lange 1978:104). One might expect to find archaeological sites under water, or perhaps, shell mounds located further inland than expected.

The Nacascolo Site

The most detailed account of Nacascolo is provided by Wallace and Accola (1980) who describe the site as lying in a small valley (ca. 1/4 km.) at the midpoint of the peninsula forming the northern boundary of Culebra Bay, Guanacaste Province (Figure 1.4). Through the excavations of the MNCR and UCLA, the site area was increased to include the hillsides and hilltops to the north, west, and south, mangrove swamp, and the beach zone to the east (Dillon 1980; Hardy 1983; Vázquez 1986). The valley slopes upward approximately 15 meters above sea level east to west, and is bounded by the hills to the north, west, and south, and by Nacascolo beach to the east. A gap between the hills to the northwest allows passage from Nacascolo Valley to Pochota Beach in Huevos Bay; the only

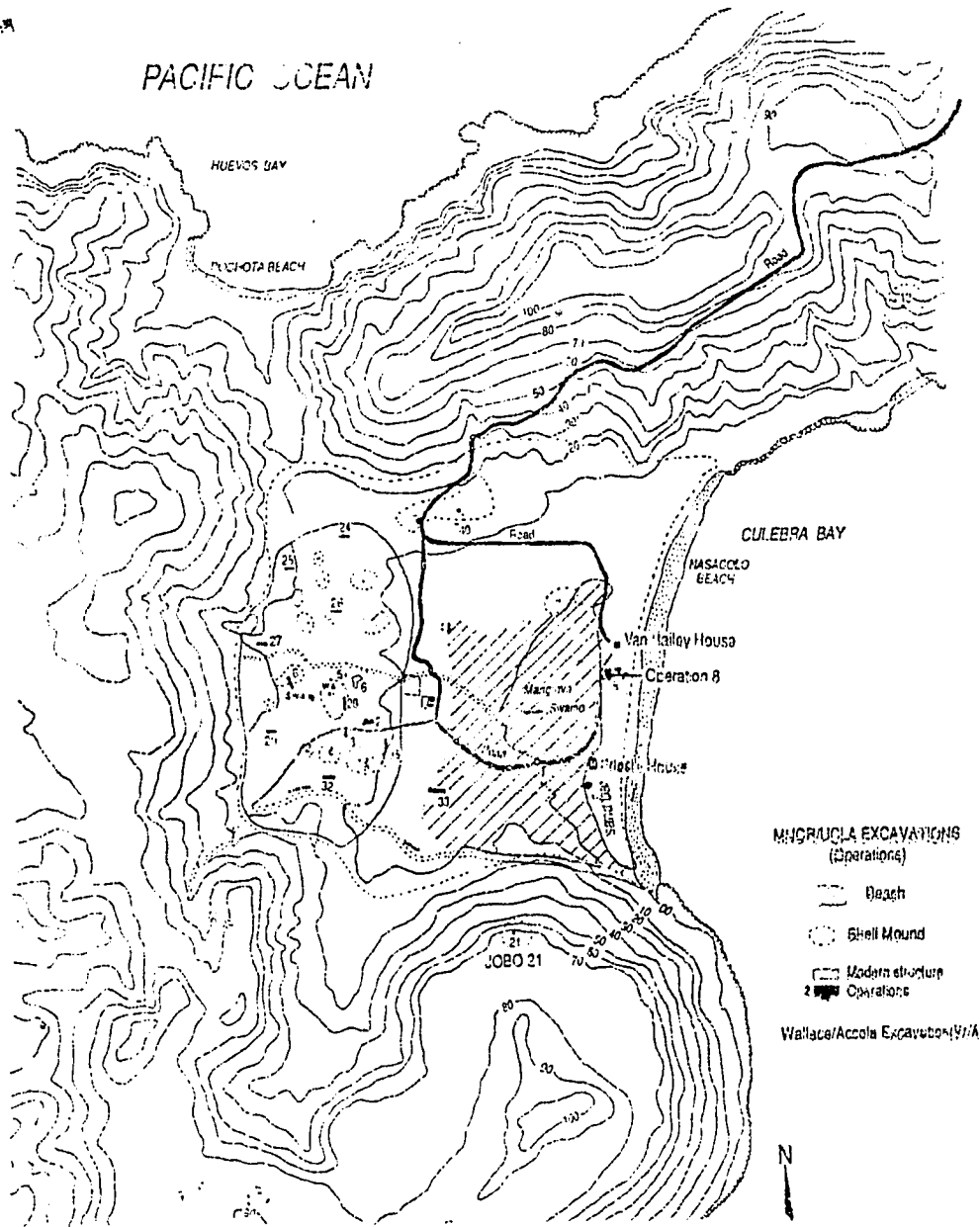

Fig. 1.4

such pass existing between the two bays, thereby allowing access to two marine environs. Two major quebradas (rainy season streams) cut through the valley and drain the hills, east to west, emptying into an estuary behind the beach. A smaller valley, formed by another quebrada, butts into Nacascolo valley from the south (Wallace and Accola 1980).

During the 1960's, several houses were constructed at Nacascolo. These include a Dominican retreat house and a smaller structure located in the southern part of the sand spit, and the Von Bailey house, located approximately 200 meters to the north of these. A fourth structure was constructed slightly inland, behind the mangrove swamp; this was destroyed in mid 1980's, and has since been replaced with a temporary structure by alleged squatters. Slash and burn agriculture is practiced today in the northern part of the valley by the site's guard and his family. Cattle ranchers have been allowed to graze their stock around the site from time to time (personal observation).

Surface surveys have recorded ca.30 shell mounds over over the entire site, approximately 20 in the valley floor (Vázquez 1986:72), a cemetery area located on the northern slope (Wallace and Accola 1980; Hardy 1983), cultural

activities on the mesa tops (Vazquez 1986), and another cemetery located on a sand spit, within few meters of the high tide line, between the Von Bailey's and the Dominican's houses (Dillon 1980; Hardy 1983). The site has been heavily looted and no area is devoid of huaquero (pot hunter) activity.

Previous Archaeological Investigations in the Greater
Nicoya Archaeological Subarea

Archaeological investigations began in 1872 with Bransford at Ometepe Island, Nicaragua (1881). Bovallais (1896) collected Nicaraguan antiquities around this same time. In 1903, Hartman (1907) conducted the first stratigraphic excavations in the Nicoya Peninsula at Las Guacas; this classic monograph, and the earlier one detailing his archaeological researches in the Central Valley of Costa Rica (1901), are held in high regard to this day. Lothrop (1926) compiled the ceramics of Nicaragua and Costa Rica, and was the first person to consider cultural contexts through ethnohistoric sources. Willey (1959) conducted excavations in southern Nicaragua attempting to discern North-South cultural contacts; and Haberland (1959) conducted excavations in southern Nicaragua. Coe and Baudez (1961) initiated what is considered the modern era of archaeology in Costa Rica and

developed the first regional chronology for Greater Nicoya, southern sector; this was quickly consolidated with that of Willey and additional material from the northern sector excavated by Norweb (1961, 1964). Baudez (1967) implemented and elaborated the regional chronology for the Tempisque river valley. Beginning in the 1970's, Lange, and students from the Associated Colleges of the Midwest (ACM) began systematic excavations in Rio Sapoa and Culebra Bay. Lange (1971a) and a number of his students have completed Ph.D. dissertations, M.A. and B.A. theses and myriad publications based on their work with Lange including Abel (1978) and Abel-Vidor (1980a,b); Bernstein (1980); Weaver and Vázquez (1980); Moreau (1980, 1983); Kerbis (1980); Hoopes (1980), Wallace and Accola (1980); Accola (1978a,b); and Ryder (1983, 1986 a,b,c); these are complemented by publications and Licénciaturas of Costa Rican students (Herrera 1982; Vázquez 1980 and 1986; Bonilla, Calvo and Salgado 1986). Sweeney (1975) reexamined Coe's material from Cahuite Escondido and Matapalo and added the regional chronology. Norr (1986) conducted surveys and excavations in the Rio Naranjo area; and Sheets (1984) and his students (Mueller 1984; Bradley 1984) have concentrated on the cordillera area around Arenal, an area earlier investigated by Carlos Aguilar. Winifred Creamer (1983) surveyed and excavated much of the area around the Gulf of Nicoya. In 1979,

Meighan (1979) and Snarksis recorded rock art just outside of Liberia at La Espanola; this project introduced UCLA to the MNCR and Costa Rican archaeology, and resulted in subsequent projects at Nacascolo by archaeologists of these institutions and their students.

History of Archaeological Investigations at Nacascolo

The earliest archaeological explorers to visit Culebra Bay and specifically the Nacascolo site in modern times were Drs. J. F. Bransford and Earl Flint in 1887 (Bransford 1881:74,76). Bransford describes the northwest side of Culebra Bay as "a narrow peninsula, in a gorge on the bay side of which is a small level space of three or four acres...The little valley was extremely fertile, easily defended, and formed an admirable location for a village in troublous times" (Bransford 1881:76). He noted shell heaps in the valley area and on hill tops and identifies them as "kitchen middens." This description of "Nagascola" as he calls it, includes an excavation account in one of the shell heaps, in which were found basalt pillars similar to those encountered at Hacienda Culebra by Flint, in features which he describes as "mounds of stone seven feet high" with "tall stones in the mounds, like the tombstones of Santa Helena" [Nicaragua] (Bransford 1881:76). Flint apparently distinguishes these

"mounds of stone" from "large shell heaps" found in the same neighborhood (Bransford 1881:76).

If, as this passage indicates, 2 types of mounds existed in Culebra Bay at that time, the easily recognizable stone burial mounds undoubtedly attracted and facilitated grave robbing, for no extant burial mounds exist today.

Flint (1882:301) however, does not elaborate the matter or even mention the distinction but briefly notes: "Also at Cubibra [sic] Bay and Nacascola [sic], accompanied by Dr. Bransford, I found numerous fossil 'shell heaps,' associated with human remains buried in their centre, and surrounded by stones."

Bransford and Flint were told by an informant that such pillars mark the position of skeletons. They do not however project above the surface (Bransford 1881:76). Stone (1948:pl.32) pictures similar "shafts" from the Sula-Ulua Plain, referring to them as grave markers (Stone 1948:181); and Strong has reported them from the Bay Islands (Stone 1948:181).

Today, pillars such as these are known as "mojones" (Wallace and Accola 1980:52) and are usually associated

with human burials when found in undisturbed contexts. A walk around Nacascolo reveals mojones strewn about the surface, often in looters' backdirt or thrown into nearby quebradas. Ignimbrite sources are located within 1/2 mile on the southwestern hilltop, and most likely required a certain degree of expertise and social cooperation in extracting and transporting them to desired locations. While modified somewhat, columnar mojones differ from the stone sculptures noted by Bransford near the sites of Panama and Santa Rosa (Bransford 1881). These "idols" as Bransford called them, are considered to be non-maya stone sculptures, characteristic of Intermediate Area statuary (Richardson 1940; Haberland 1973; Bruhns 1982) and were once apparently abundant at Nacascolo bringing the site fame (Stone 1958) as well as looters.

Bransford (1881:76) described "huacas" (evidence of grave robbing) "on the hills in every direction" thereby indicating the extensive degree of looting which had occurred prior to his arrival. Similar comments are repeated by virtually every archaeologist who has visited the site, or for that matter, throughout Costa Rica. One looters pit, located in the central valley of Nacascolo, measures over 5 meters in diameter, a testimony to the prolific grave robbing. Examination of this pit by archaeologists revealed a mojon imbedded in the western

profile (Plate 3). Some of the ceramic vessels obtained from this excavation (in the private collection of Juan Dada) have been recorded by Baudez (1970), Stone (1977) and Wing (n.d). Local legends relate "giant mojones that took eight men to carry" and jade and gold objects among the grave offerings excavated. Other than these tales, no gold has been reported from Nacascolo.

Flint (1882:295) calls professional grave looters "Huaceros." Today they are commonly referred to as "huaqueros" which, simply translated, means digger of holes.

Although the Costa Rican government has, over the last twenty years, passed laws outlawing looting in order to protect their cultural patrimony, this deliberate destruction of cultural resources continues today. While working at Nacascolo in December, 1988, I encountered huaqueros excavating burials at Playa Jicaro, the next bay south of Nacascolo (Hardy 1989). I will discuss aspects of this encounter in following chapters.

Returning to archaeological investigations at Nacascolo, at the end of the 1950's, Baudez conducted the first scientific excavations, as part of his areal chronologic sequencing (Wallace and Accola 1980:52).

Doris Stone and Carlos Balser reportedly excavated a small pit in a shell mound at Nacascolo (Wallace and Accola 1980:52), but apparently no excavation report was made, and I am unaware of the specifics of their investigations. Stone (#1439) has described grave furnishings "unearthed" at Las Palmas on the sea side of Nacascolo by Ramon Alfonso Montero Ocampo. While no mention is made of skeletal remains, Stone nonetheless, indicates that the burial "began 3 meters below the surface of the soil and was 4 meters deep" (Stone #1439:1). Stone (#1439:4) associates the grave offerings with the Early Polychrome Period. Stone's location of Las Palmas is confusing, for I know no area of Nacascolo as Las Palmas. She may have meant Palmares, which is located on the sea side (Pacific), but is not considered Nacascolo. She mentions the excavation "behind the house of the Salesian fathers," but the retreat house at Nacascolo is owned by Dominicans.

Haberland (1973:146) apparently visited Nacascolo at some time, for he refers to sherds collected from the site as "undoubtedly Middle Polychrome period." He uses this as a reference to cross-date Pensacola statuary to this period, he does not however, specify where or what he did at Nacascolo.

The most comprehensive report of scientific archaeological investigations in Culebra Bay have been detailed by Lange (1979b), and Lange, Accola and Ryder (1980), as part of an archaeological impact report to the Proy ecto Turistico Bah a Culebra, on the area imperiled by an extensive tourist development project, planned for Culebra Bay. Lange located 60 sites around the bay and ranked them according to their archaeological content, also according to the scheduled plan of destruction and construction of the proposed development. Nacascolo was designated as one of the areas to be greatest affected. Part of this archaeological assessment included site survey and mapping, as well as limited excavations at Nacascolo, which had been surveyed, although not systematically, in 1973 by a group of students from Beloit College, under the direction of Lange. He had been conducting archaeological investigations across the bay at Vidor (Wallace and Accola 1980:52).

In 1978, a more thorough survey and limited excavations were conducted at Nacascolo (Wallace and Accola 1980:52). In addition to mapping the site and noting apparent cemetery areas on the northern hillside and valley floor, Wallace and Accola excavated a human burial consisting of a primary interment placed on its

back in an extended position, accompanied by the secondary remains of 6-8 individuals "stacked alongside" (Plate 4). Accompanying grave offerings date this burial to the Monte del Barco phase of the Middle Polychrome Period (1000-1200) A.D. (Wallace and Accola 1980:58).

In 1980, salvage excavations, financed primarily by the Proyecto Turistico Bahia Culebra, were jointly conducted by the Museo Nacional de Costa Rica (MNCR) and the University of California, Los Angeles (UCLA), under the direction of Michael Snarskis, Ph.D, and Ricardo Vázquez L. of the MNCR and Brian D. Dillon, Ph.D, of UCLA. All ecological areas were tested including hillsides, valley, shell mounds, mesas, mangrove swamp, and inland beach zone (Dillon 1980; Vázquez 1986).

Two cemetery areas were excavated; the first, located on the northern hillside, was originally identified as a Zoned Bichrome period cemetery (Wallace and Accola 1980; Lawrence 1981), although I am uncertain upon exactly what this temporal distinction was based, since only one Zoned Bichrome period sherd had been found in site survey and its provenience is unknown (at least to me). Lawrence (1980), however, indicates that a survey, conducted around the cemetery prior to excavations, revealed Zoned Bichrome sherds. The eastern and western ends of the proposed

cemetery were tested. In the eastern section, the excavation designated Op.3B was halted after realizing the excavation was removing disturbed material; looters had backfilled a tomb in attempt to hide grave robbing activity. Excavation in the western section (Op.3A) revealed a cist tomb constructed of columnar ignimbrite mojones (Plate 5; Lawrence and Hardy 1982; Hardy 1983). No osseous evidence survived soil acidity, but teeth slivers, in a confined area, soil distinctions, as well as the size and shape of the tomb suggest the deceased was placed in an extended position, head to the west (Lawrence and Hardy 1982). The grave offerings date to the Early Polychrome Period, 500-800 A.D. (Lange et al 1984), somewhat later than the Zoned Bichrome Period originally assessed this cemetery by Wallace and Accola (1980).

The second cemetery was discovered during a survey of the inland beach zone, actually a sand spit between the manglar (mangrove swamp) and the bay (Figure 1.4), marked by the presence of a fallen mojón (Rechtman 1980; Hardy 1983; Vázquez 1986). Excavation here (Operation 8a-e), a 7x7 meter pit, revealed 37 primary interments placed in variations of flexed position and several placed in extended position.

The following field season (1981), UCLA and a number

of volunteers from a University Research Expedition Project (UREP) continued excavating the OP. 8 cemetery. They added a 6x7 meter pit (8F), contiguous to the western wall of the previous years excavation, and extended a 32x2 meter trench (8G) east from the eastern wall of 8 A-E, and a 1x5 meter trench (8I) to the west of 8a-e (Figure 1.5). This trench provided a 50 meter profile of the Nacascolo sand spit. By the end of the field season, despite inclement weather, 77 human interments, 1 canid (Canis sp.), 261 artifacts, and ten cultural features were uncovered, and of course, cultural material and bones were seen in nearly all sidewalls indicating the cemetery's extended and unknown area.

Meanwhile, MNCR Archaeologists were excavating an approximate 3% random sample of Nacascolo (Vazquez 1986). Salient recoveries included additional Zoned Bichrome period sherds, thus supporting Wallace and Accola's (1980) assessment of Zoned Bichrome period occupation (albeit originally based on one representative sherd). Information obtained indicates the site was occupied continuously through succeeding temporal periods until just before the arrival of the Spaniards (ca.1522). Vázquez (1986) reports encountering "housefloors," possibly a "household cluster" (Winter 1978:25), beneath a shell mound, which he believes is associated with some of

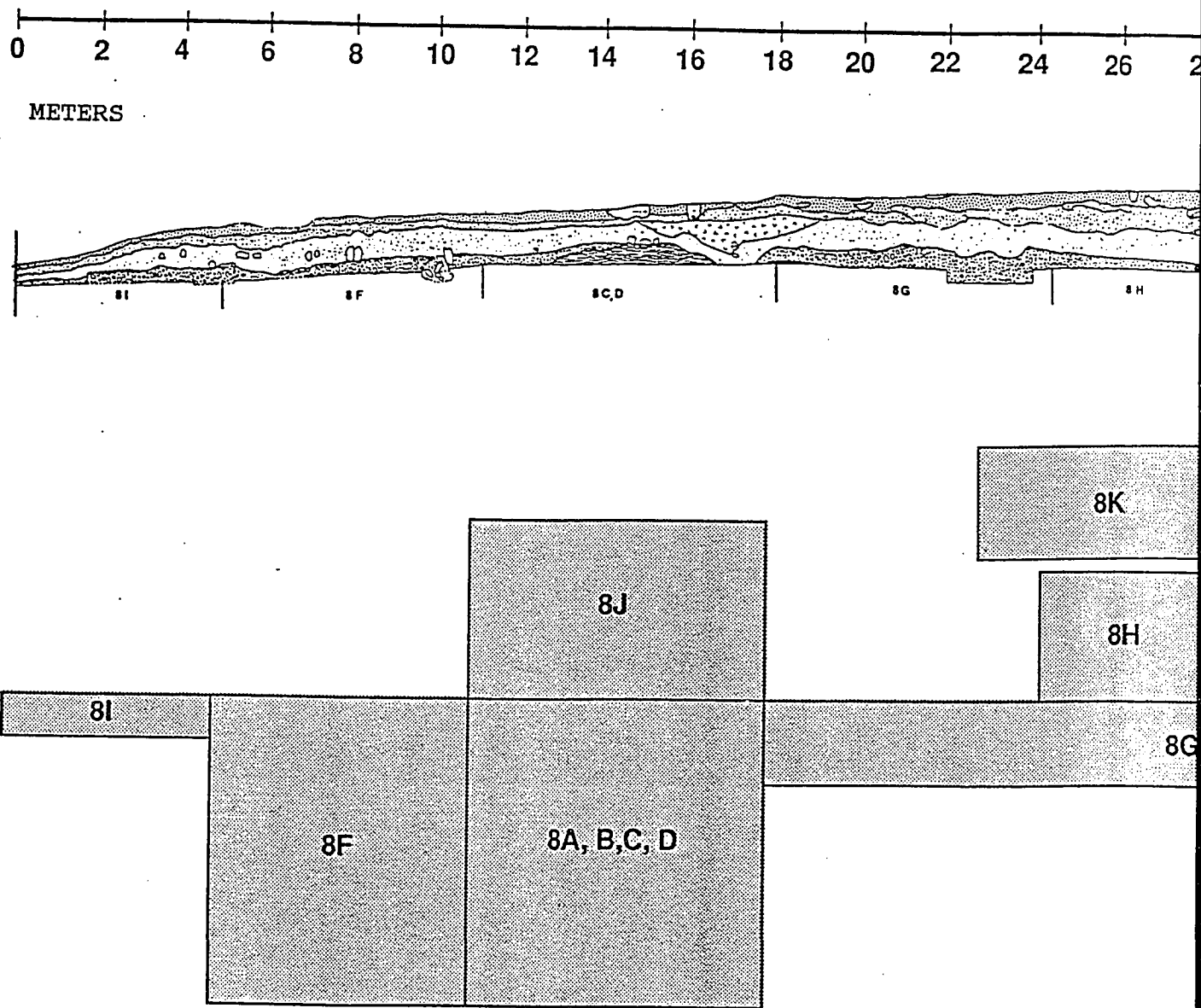
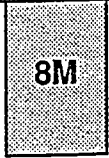
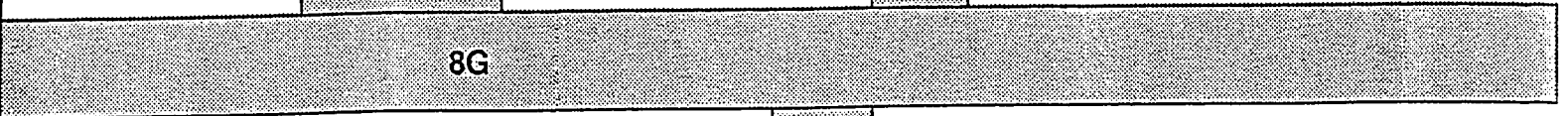
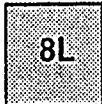
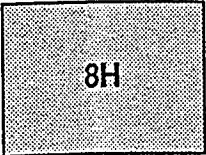
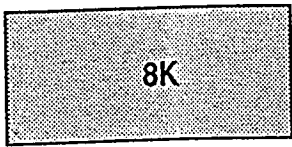
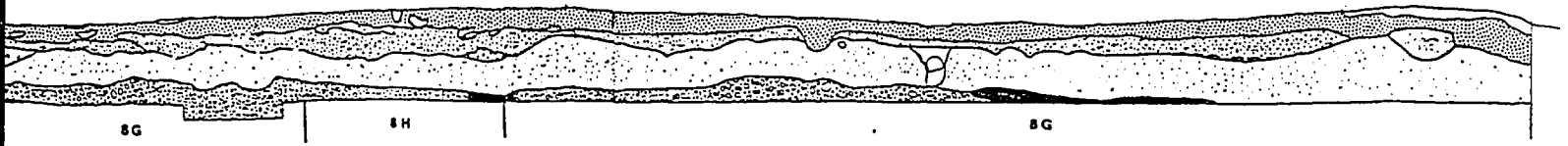

Fig.1.5 Nacasclo beach cemetery (Op.8A-M), stratigraphic profile and excavation layout.



20 22 24 26 28 30 32 34 36 38 40 42 44 46 48 50



p.8A-M), stratigraphic
it.



30 32 34 36 38 40 42 44 46 48 50

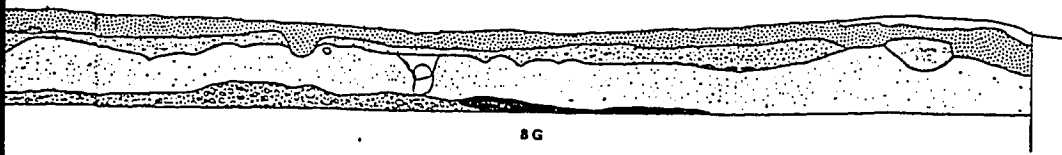

8G

8L

8M





the beach cemetery interments (Plate 6). This is important for it provides evidence of a resident population whose remains are found in the beach cemetery. Burials were also found in housefloors, and around habitation areas dating to the Middle Polychrome period (Vázquez 1986). Late Polychrome burials were recorded on the hilltop sites at Jobo and Cascabel (Lawrence 1981; Vázquez 1986).

Although the beach cemetery was excavated over two field seasons, a number of pertinent questions remained unanswered; cemetery boundaries (horizontal and vertical) were never determined. Furthermore, for reasons of differing objectives, tight control was not observed in collection of cultural features. Robert Rechtman, crew chief for the 1980 excavation, stated the main objective was to "get down to tomb level" (Rechtman 1980:5). As a brief and preliminary assessment of the area I do not fault excavation methods [Dillon's]. However, whereas Rechtman's excellent field notes detail the burials, his brief descriptions of overlaying sherd and/or rock concentrations, albeit noted, are insufficient in reconstructing mortuary behavior. The 1981 excavations, under crew chiefs John Verano and this author, recorded cultural features more thoroughly; but excavation methods did not permit cemetery boundary assessments, and vertical

sterile was not reached. To address these problems, I returned to Nacascolo at the end of 1988 and continued excavating the beach cemetery (8J-M), painstakingly recording and assessing the features constituting mortuary offerings and practices, excavating all pits to sterile, and employed a "shovel testing method" to help resolve boundary problems (Hardy 1989). This is discussed in Chapter 3.

At the beginning of 1982, sometime after the departure of MNCR archaeologists, and in spite of a guard residing at the site, the beach cemetery suffered its first looter attack. At least six pits were dug near the Op.8A-H excavations. The neat, rectangular shape of some of these pits (Plate 7), as opposed to usual oval looter holes present throughout the site, suggest the looters had observed our excavations, or perhaps even participated in them; sherds and human bones were found in the looters backdirt. The culprits were not apprehended.

Although only a portion of the cemetery has been excavated, the skeletal sample, blessed by unusual (for Costa Rica and the tropics) bone preservation, represents the oldest and best preserved human skeletal population, thus far scientifically excavated in Costa Rica (Figure 1.6: located in back envelope).

Areal and Cultural Definitions

Culturally Costa Rica has been defined as part of the Circum Carib tribes (Steward 1948:4). This phrase was used to describe the scattered peoples in tropical and subtropical climates of varying altitudes, and included the land of lower Central America, the Caribbean islands, northeastern South America, including the Andes and parts of Colombia. The largest political unit was the Chiefdom, which was often a loose federation of localized tribes banded together for purposes of war or ceremony. There was no permanent administration such as those found in a state society (e.g. the Aztecs). The tribes encountered by Oviedo in Nicaragua and Costa Rica (ca. 1520's) are typical of such chiefdoms.

Geographically and sociopolitically between the two areas of high civilization, Mexico to the north and the Central Andes to the south, the "Intermediate Area" as defined by Willey (1959), consists of the lower part of Central America, including eastern Honduras and Nicaragua, Costa Rica and Panama, all of Colombia, and the northwestern Andean corner of Venezuela (Figure 1.1).

At the time of European contact "Greater Nicoya" marked the southernmost limits of Mesoamerica (Norweb

1961,1964). Kirchoff (1943) defined Mesoamerica, as a geographical and cultural area based on shared cultural traits over a wide region extending from West Mexico to the Nicoya Peninsula, Costa Rica.

The interrelationships between Mesoamerica and south America in the development of complex societies in central America have long interested archaeologists, and various studies have focused on cultural similarities and differences Greater Nicoya shares with these two regions (Spinden 1925; Kidder 1940; Lothrop 1940; Coe 1962b; Eckholm and Evans 1962; Norweb 1961,1964; Stone 1972; Lange 1971b). The approaches taken in identifying southern from northern influences have most often taken the form of trait lists, and have been used to measure the extent of the high culture areas of the north and south upon the seeming backwater of the Central America. While the presence-absence categories are useful for preliminary study, they tend to gloss over significant cultural differences (Lange 1971b:43). Comparisons with the more complex societies of North and South America have always resulted in discussions of the failures of the Intermediate peoples to achieve the high levels of political, social, economic, and religious development, that are so striking in Mesoamerican and Andean societies.

Payson Sheets (1987:1) provided a fitting analogy when he referred to the Intermediate area as the "Hoosiers of Middle America," the rural country bumpkins compared to the urban sophisticates of California and New York. The area's middle location, he suggests, amounted to a "Fresno Factor" (Sheets 1987:5) such as found between the two California metropolies Los Angeles and San Francisco, in which the area is bypassed or passed through quickly but doesn't really interest anyone enough to stay.

Sheets stresses that adaptation to diverse ecological niches resulted in the emergence of diverse cultural patterns and levels of social evolution within Costa Rica. By avoiding the state level of political development and external domination, early cultures maintained greater economic independence than interdependence. Costa Rica is noted for relative stability in population, adaptation, economies, and societies for many millennia (Sheets 1987:23).

Coe (1962b:170) referred to Costa Rica as a "frontier country" ... "the real meeting place between the cultures of North and South America." He lists Greater Nicoya as one of the fringe areas of Mesoamerica which "failed to share in any of the spectacular developments such as cities, large-scale ceremonial centers, or dated stone

monuments" (Coe 1962b:176). This appraisal appears more a result of Coe's Maya-colored glasses, than an actual assessment of cultural complexity; such comparisons ignore Intermediate Area achievements, and prejudice interpretations.

The phrase "frontier zone" was used by Baudez (1975:1), and adapted by Lange in his buffer/frontier model that viewed trade as the bridging network (Lange 1979a).

Although evidence of direct occupation or intensive contacts between Greater Nicoya and the two high culture areas is lacking, it is believed the areas were in contact by an exchange network which brought exotic items. Trade was mostly by sea. As a model for this, Abel-Vidor (1981) proposed the area an "interaction sphere" in explaining the differential acculturation where inter-group contact is intermittent and not overwhelming.

Lothrop (1926) was one of the first to recognize the cultural diversity in Central America through its stratified ceramics. Together with George Vaillant, he developed the "Q Concept" (Vaillant 1934:90), a theory based on the widespread variety of pottery traits primarily associated with non-Mayan cultures but including

Playa de Los Muertos culture and later mortuary ideas behind Doris Stone's "basic Central America culture, or cultures" (1948:169), the early widespread interamerican cultural horizon recognized earlier by Kroeber (1930) as "common Middle American material," and attributed to the expansion of Arawak groups originating in the Orinoco basin (Lothrop 1940:425). While Coe (1962:177) has criticized the Q-concept as essentially Mesoamerican in concept except for the introduction of Polychrome pottery, it appears that Kroeber, Valliant and Lothrop, and Stone are correct in their general interpretations of this early horizon; it is from this formative tradition that evolved the more complex societies.

Steward (1948) proposed that the Circum-Caribbean complex was associated with the Formative Period and that it spread through northern and eastern South America, the Antilles and "Nuclear America." In the latter area, according to the postulate, it laid the foundation for the subsequent development of the "high cultures" in the Andes, Mexico, and Guatemala. Steward proposed that the Tropical forest people originated out of the Circum-Caribbean complex as it spread from the Andes to north into Central America and east through Columbia and Venezuela where it bifurcated, one culture stream going out to the Antilles the other proceeding south down the eastern coast

of Brazil. As this culture complex spread into areas where it could not maintain all of its cultural elaboration it lost many of its socio-political and religious patterns, as well as metallurgy, but it retained and/or acquired certain technological traits which made possible an adaptation to the fluvial, littoral and rain-forest areas. According to Steward, far from being derivative, and relatively recent phenomena, the tropical forest culture appears sui generis and relatively ancient (Chapman 1959:162-163).

Steward believes the inability of the religion to adapt to new ecological conditions contributed to diminishment of the social complexity which it had as a Circum-Caribbean level of complexity resulting in a more a Tropical Forest type of social organization. Much of the religious complexity was lost.

Chapman (1958:169) noted that various archaeologists have found that this theory does not apply to their particular area of research. Rouse's (1953:196 as cited by Chapman 1958:162) data for example, indicates that the tropical forest people have been in the area longer than previously supposed; they were responsible for the introduction of agriculture and pottery and their culture was succeeded by the Circum-Caribbean only in two widely

separated parts of the area; the greater Antilles and northwest Venezuela.

Evidence suggests that the Circum-Caribbean culture did not diffuse as postulated and may not have had a single origin or cultural expression of the Formative Period stage, suggesting the Circum-Caribbean concept has a certain validity as a classification of cultures on one time level but lacks the requirements of scientific method as a hypothesis of historical reconstruction (Chapman 1958:170). Chapman concludes that the lowland tribes of Nicaragua had a very ancient, unstratified, sweet manioc farming "Tropical Forest" type of culture, not "Circum-Caribbean as previously thought by Steward. Linguistic, archaeologic and cultural evidence all indicate that the lowland tribes belong to an ancient So. American tradition and one of the most archaic farming cultures, that of sweet-manioc farmers (Chapman 1959). She describes a relatively uniform culture where hunters and gatherers turned to incipient farming which included cultivation of corn, beans, squash, cotton, and tobacco. Formative, more sedentary, larger communities are archaeologically determined by ceramic styles and forms and as a whole the sites are homogeneous consisting of mounds and ceramics.

The fact that Lowland culture have so many south

American traits attests the original immigrants brought these traits with them when they came from the south. These traits include the cultivation of sweet manioc, sweet potato, "malanga", pineapple, blowgun, hammock, platform bed, wooden stools, bark cloth, drinking feasts, cannibalism and palisades (Chapman 1959:162).

The sweet manioc cultivation, to the exclusion of bitter manioc, suggests they probably departed from South America in very ancient times before the advent of technology necessary for the cultivation of bitter manioc (Chapman 1959:162). No examples for bitter manioc have been found in Central America. The distribution of bitter manioc from the Amazon to Peru and northwestern South America wherever both types were cultivated the bitter type was by far the most important (Chapman 1959:163). Sweet manioc, baked or boiled, is eaten like a potato, but the bitter variety necessitates a complex processing in order to remove the hydrocyanic acid (Chapman 1959:163). The assumption is that the sweet varieties were brought under cultivation prior to the bitter. The lowland tribes of eastern Nicaragua apparently migrated from northwestern south America. According to Sauer (1952) northwestern South America is the hearth of agriculture for the New World during the third millennium B.C..

Lower Central America stood in the unusual position of being peripheral to three major culture areas: Tropical Forest, Andean, and Mesoamerican, each with a strong co-tradition. Although many significant traits by-passed the area via the sea route, some were borrowed and assimilated, while others, were local inventions. At times, sections of this peripheral area were more closely related to one or another of the major cultural units, but independent growth was always of great importance (Norweb 1961:36).

Ethnohistoric/Ethnographic Background

The most comprehensive guide to ethnohistorical sources for the Greater Nicoya Subarea is provided by Suzanne Abel-Vidor (1980b, 1981). Early visitors such as Gil Gonzalez Davilla, Cereceda, and Oviedo y Valdes, travelled throughout the region taking account of conquest booty, yet they make scant, or no mention of the Bay of Culebra. This is possibly due to two reasons: (1) the bay was not visited and (2) the relative sparse habitation of the area warranted no mention. The former point appears unlikely since Culebra Bay has long been known as one of the best (Barrantes 1891:8) and relatively safe harbors in Costa Rica (Gerhard 1960), an excellent place to wait out the frequent Pacific storms. This phenomenon was observed

by this author in 1981, when rough seas prohibited small craft navigation across the bay. Many larger boats, ordinarily moored at Bahia del Cocos, entered Nacascolo Bay seeking refuge in calmer waters. The later point makes sense if one considers the archaeological evidence suggesting site abandonment before the Conquest, that is, the lack of evidence indicating historic period contact.

Population for the Guanacaste hinterland and the Nicaraguan lake region at contact, based on reports by Oviedo and Herrera, has been estimated at 500,000 (Abel-Vidor 1981), although this has since been determined to be a relative rather than absolute estimate (Abel-Vidor personal communication to Lange 1984:188). By 1554, a census describes the area as "desplobado" _desolate, without people or water. Guanacaste was drought-ridden and barren.

At Conquest, Greater Nicoya area was inhabited by groups with three linguistic affiliations. The largest group, the Nicarao were a Nahuatl speaking people who, by their own accounts, were relative newcomers to the area. The second group were the Orotina or Chorotega-Mangue. They were considered to have inhabited the area for a long time. Like the later Nicarao, they too were believed to have migrated from the north (Lothrop 1926, Chapman 1960,

Stone 1966b). The third linguistic stock was that of the Corobici or Chibchan who had their roots in the south and apparently were occupying the Greater Nicoya area prior to the 9th century A.D. (Stone 1966b).

Well-established legends trace the path of the Pipil Nicarao from Mexico, with the Chorotegan migration occurring considerably earlier than the Nicarao. This much archaeologists accept as fact, but the exact arrival dates remain controversial. Arrival dates in Nicaragua and Costa Rica have been estimated from the legends, their confirmation must depend on archaeological proof.

According to Spinden (1925), and Lothrop (1926:I:22,93 and II:394,416), there was a possible fourth century Chorotega migration from Chiapas. This is based on certain motifs on Nicoya Polychrome and certain stylistic characteristics of the stone sculptures. Spinden first hypothesized that the Chorotega originated with the Maya, and diminished overland from the wetlands in the Gulf of Mexico towards Ecuador, as the first American horizon of agriculture. That is, that agriculture was brought from southern Mexico to Central America by the Chorotegas at a time immediately after the archaic horizon (Chapman 1960:110 note 195). Stone (1966a) proposes that Nahuats-Pipils groups (Chorotega-

mangues, Maribos, etc.) began a series of migrations from the north during A.D. 500-600, probably pressured by the Toltecs, to leave the area of Cholula, Mexico. They brought with them a religious complex of southern Veracruz, and populated parts of the north isthmus of Guatemala and El Salvador. It is supposed that these people were the creators of San Juan feathered style ceramic (Stone 1966a:1).

Lothrop (1959 1:172, cited in Stone 1966:1) first suggested that a branch of these Nahuats-Pipils were the merchants responsible for the appearance of gold figures found at Venado Beach, Panama which date around A.D. 250 . It appears that it took five centuries for this technological process to arrive (Root 1961:255 as cited in Stone 1966:1), for further to the west, at Tazumal, El Salvador, a radiocarbon date of A.D. 751 was obtained for two gold and copper figures from; this suggests Costa Rica as their manufacturer. In association with these figures were found objects related to the game of pelota brought by the Nahuats-Pipils "tajinizado", Ulua Polychrome Ceramics, and other things associated with Nahuat-Pipil culture of Central America (Boggs 1954:33-36; Longyear 1952:8 as cited in Stone 1966:2). The Nahuats-Pipils are considered a single cultural entity and their distinctions influenced by their ultimate destinations, the Pipil in

Guatemala, El Salvador and Honduras, and the Nicaraos in Nicaragua and Costa Rica (Fowler 1989).

According to Stone (1945:122), with the exception of the Maya, the Chorotega were the creators of one of the more high cultures known in Central America. Outside of Costa Rica we find the Chorotega in western Nicaragua, south coast of Honduras, in southern El Salvador, and in the states of Chiapas and Oaxaca (Stone 1945:121-122).

Other branches of this group remained in Mexico, established themselves in Tula and Cholula, and later penetrated into Central America, possibly under pressure from the Chichimecas, AKA the Tula-Toltecas. The last Nahuatl-Pipil group arriving in Central America were the Nicaraos. They entered the isthmus region at the end of the 10th century (Tozzer 1957 t.1:18 in Stone 1966a:2), arriving in Nicaragua and Panama between A.D. 1000-1100, and the Nicoya Peninsula A.D. 1200. The Nicaraos displaced the Chorotegas from land that they had acquired from the Corobicis (Stone 1966a:2). The Nicaraos brought a strong religious tradition of Teotihuacan (Stone 1966a:2), with stylistic traditions indicating Veracruz and Tabasco, that reminded Lehman (1913:92-97) of the polychrome ceramics of Cholula, and Ulua Valley, Honduras (Stone 1966a:2,4).

As evidenced by their language and religion the Chorotega are Mexicans, while their neighbors in Central America, the Chibchas, have southern roots (Stone 1945:129).

According to the interpretations of Lothrop, Stone, and Chapman, there were apparently, a number of migrations by all three groups in both directions, north and south. Traffic in the Intermediate Area appears to have been very heavy if all these interpretations can be supported with archaeological evidence.

Archaeological Evidence of Foreign Influence or Migrations

Foreign influences and migrations, from both northern and southern origins, are evidenced archaeologically in Culebra Bay sites, particularly Nacascolo and Vidor. Archaeological examples of northern influences are evidenced in alabaster vases of Sula-Ulua Valley, Honduras, Tohil Plumbate, certain classes of Nicoya Polychrome, Ulua Polychrome, and Chac Mool figures.

Most of the evidence for foreign influence at Nacascolo and other sites, is derived from non-scientific excavations. Stone (1972, 1977, #1439), Baudez (1970), and Wing (n.d.), have discussed some these grave offerings

from private collections with Nacascolo provenience. Some objects reported from Nacascolo, indicative of southern influence include a carved conch shell trophy-head necklace (Stone #1439:2-3), carved bone with serpent designs (Stone 1963:358, Fig. 34), and a carved antler in the form of an "alligator god" (Stone 1963:352, Fig. 20). Additional objects believed to have southern derivation include carved bone sometimes resembling a "canine tooth" (Stone 1963:347). Both the alligator effigy and long beaked birds are symbols of fertility in the south (Stone #1439:3).

Stone (1966a:1) proposes that around A.D. 500-600 there were a series of migrations into Central America from the southern hemisphere. Evidence for what she considers Arawak presence in Guanacaste consists of aspirators, with one or two inhalation tubes, for use with cojoba (Piptadenia sp.) or tobacco (Nicotiana sp.); jade amulets in stylized form of frogs, beaked birds, and hanging wings (colgante alado), are all elements associated with territories with relation to the Arawaks of South America. And all these elements are found at Linea Vieja, and in Guanacaste as well (Stone 1966a:1). Lehmann suggested that the El Viejo ceramic "Linea Negra" has Arawak influences (1913:99;1920 B,1:71 as cited in Stone 1966a:1). Chapman (1960) disagrees with Stone's

Arawak expansion into Guanacaste. But inhalation tubes, and their association with tobacco and shamanic concepts, well documented in ethnographies of Venezuela, Columbia, and Ecuador (Reichel-Dolmatoff 1965; Wassen and Holmsed 1963; Wassen 1965; Wilpert 1987), are found archaeologically in Costa Rica at Linea Vieja (Stone 1966a:1), and at Nacascolo.

Stone (#1439:3) mentions two clay 'spoons' or tablets, which resemble tablets used in pre-Columbian times in Panama and the south, for mixing snuff made either from tobacco (Nicotiana sp.) and lime, cojoba (Piptadenia sp.), or coca (Erythroxylum).

Northern influence is evidenced in the ceramic assemblage beginning in the Early polychrome Period (500-700A.D.), as demonstrated by Mesoamerican inspired iconography appearing on Galo pottery.

During Middle and Late Polychrome Periods, an increase in foreign influence is seen in alabaster vessels, Tohil Plumbate, and Uloa Polychrome vessels. Lothrop's Nicoya Polychrome "estilo Bahia Culebra" is from Nacascolo (1926 vol.1:107-108). It has motifs which refer to the northern pantheon, in particular, the fight of the Man-eagle or the fight between day and night, and

Quetzalcoatl, the feathered serpent, another rain god that has characteristics of jaguar.

Juan Dada discussed his excavations at Nacascolo with Stone (1966a). He commented on the crude, or rough columnar rocks with pointed base (mojones?), three skulls without deformation, and a small human figure of molded copper, reminiscent of the style of the Tarasca region of Mexico.

Several vessels from Dadas collection, derived from the north, include two Tohil Plumbate vessels, examples of monochrome Red Ware, vessels of a type associated with Ulua Polychrome, and Nicoya Polychrome effigy vessels with human face. One of the Tohil Plumbate vessels is similar to one published by Lothrop (1926 vol.1:132 fig.38b). From another Juan Dada excavation, this one underneath a shellmound, came "one of finest examples of effigy of Chompipe" (Lothrop 1964:143, in Stone 1966a:3). These motifs are typical of the symbolism and religion Nahuats-Pipils brought with them from the north into Costa Rica.

Additional grave offerings with Nacascolo provenience, from contexts other than scientifically excavated, include three alabaster vessels, a few jade tubular beads of poor quality (Stone 1966a:3), and an

artificially deformed human cranium, with holes, to suspend it as a trophy (Stone 1963).

The Chorotega-Mangue are associated with Red Monochrome Ware, Alligator ware, Nicoya Polychrome, Chocolate effigy vessels (Lothrop 1926, Vol.2:390), and possibly other types. Healy (1980) and Day (1984:238) associate the Chorotega with Papagayo polychrome and Vallejo polychrome with the later Nicarao (Day 1984:238). Stone (1963:3) indicates that the chompipe effigy, a human face with white background, and the use of red paint, indicate the Nahuats-Pipils such as the Nicarao. The marble vase and artificially deformed skull in the same pit (albeit looters), suggests trade, and not necessarily migrations. According to Oviedo (1855:tomo IV), at conquest, the only people in Central America, who artificially deformed heads, were the Nicarao.

Pottery representative of the Nicarao has been identified as Managua Polychrome (Lothrop 1926:214-217). Haberland saw it as having enough "mexicanism." Their distribution, according to Lothrop, is the Managua-Masaya region, which he defined as the triangular area bound by the two great lakes and the Pacific Ocean (Haberland 1975:552).

The Late Polychrome shows a number of Mexican styles such as "Castillo engraved," Vallejo Polychrome, and Mombacho Polychrome, with elements that have been recognized as gods "Quetzalcoatl, Ehecatl and Tlatecutli (Healy 1981:5). The Nicarao also had the calender almost identical to the Aztecs and they spoke Nahua the language of the Aztecs.

While most archaeologists date the Nicarao migrations somewhere between A.D. 800 and 1200 (Baudez 1970:139; Chapman 1960:17; Stone 1972:170), Haberland on the other hand, has provided evidence he believes indicates that Managua Polychrome, and therefore the Nicarao, arrived in the vicinity of Managua before the middle of the fourteenth century. Similarities between Nimbalaria Trichrome and Managua Polychrome (the former is part of the last Chiapanec phase, Tuxtla), date from AD 1350 till conquest time. All this, he believes, would explain the still pure Nahua-culture exhibited by them and described by Oviedo, Martir and others. Although, this is contrary to the theory of Borhegyi (1965 cited in Haberland 1975:558-559).

Haberland noted differences of opinion, as to the exact boundaries of the Nicarao territory, at the arrival of the Spaniards, but all agree that they occupied the

isthmus of Rivas and the island of Ometepe. This has been stated in general accounts about Central America (Baudez 1970:139; Stone 1972:170) as well as in specialized ones (Chapman 1960:17). However, Stone, in an earlier article, published in the Handbook of Middle American Indians, wrote the "Corobici extended from Costa Rica into the Solentiname Islands and may have been the original tongue of the Isthmus of Rivas and Ometepe Island" (from Ponce 1973 1:369, cited in Stone 1966b:213). This statement conflicts with Stone's indication on the accompanying map depicting the distribution of the indigenous languages of Central America at the time of the conquest: Nahuatl language only for the southern half of Ometepe and Chorotega-Mangué for the northern one.

Schmidt, in an unpublished study, demonstrated the absence of Nahuatl and possibly also the absence of Chorotega groups on Ometepe (personal communication to Haberland 1975). This is corroborated through archaeological excavations of Schmidt and Haberland (1962/63). The late ceramics on Ometepe island, particularly Luna Ware, have nothing in common with the Mexican types of motifs, and they are associated with distinctive mortuary practice: urn burial, often with capping vessel; both primary and secondary remains; individual and multiple interments. Luna Polychrome is

intrusive but not from northern affiliation. It is most likely from Chibchan speakers from South America. This type of urn burial, with capping vessel, is associated with Chibchan related groups, prevalent throughout Panama, Colombia and Venezuela .

The primary burials of "Ometepec" were placed mainly in squatting positions in the urns. Although the burial urns appear too small to have contained primary interments, Bransford (1881:9) described one such urn from Ometepec as follows: "one of the workmen, five feet, five inches tall, and weighing 125 pounds squatted comfortably in [26" diameter burial] this urn, his head being amply covered by the [accompanying 18" diameter and 13" deep] cap." Bransford also excavated a cist tomb which he believed was older than the urn burials (Bransford 1881).

At this same time a new kind of stone sculpture (Chontales) appears in the form of alter-ego figures. First identified by Nordenskiold (1930); these are primarily figures of men with a carved animal or reptile on his back or his head. The alter-ego denotes the "other being" or "other self" of the person. Figures like this are common in Nicaragua, especially on Lake Ometepe (Bransford 1881; Lothrop 1926; Stone 1958:33). Alter ego figures are also important in San Agustin, Columbia (Duque

Gomez and Cubillos 1979; Reichal-Dolmatoff 1965,1972; Bruhns 1982a,b), and have also been reported for Culebra Bay. The Nacascolo statuery was once considered impressionable (Stone 1958), although no extant examples are found at the site today.

One alter-ego figure, with Nacascolo provenience, resides in the Colegio Seminario in San Jose. Originally published by Cabrera (1924:279), and subsequently reproduced by Richardson (1940:413), Strong (1948:123, figure 17 b), and Stone (1966:8, fig.2). It is a human male figure with a reptile headdress. The central tooth, penis, and complete nude figure, signals a southern derivation. The Nacascolo statue has precedents with statuery at San Agustin, Columbia, which have been associated with the "moon animal figure" of the Central Andes, and dated 150 B.C.-A.D.400 (Bruhns 1982a:196). A difference exists between the alter-ego figures of the Intermediate Area and those of Mesoamerica; mesoamerican alter-egos cover the entire head whereas those of South America lie on top of the head. Lothrop (1926:vol.1:91) was the first to suggest that the human figure, within the face of an animal, appears a Mexican or maya style, and when it appears in the other manner it is of southern origin.

No doubt these figures played an "alter-ego" role, and show a southern concept that clashes with the "nagual" associated with the north (this will be discussed more thoroughly in Chapter 2). This uniform statuary style is found, most characteristically, representing human head and animal form surmounting the head. They are reminiscent of statues found in Costa Rica, Nicaragua, and Honduras; they are also found in areas considered void of Middle American characteristics such as southern Colombia, northern Peru at Callejon de Huaylas, and the Titicaca basin on the Peruvian-Bolivian border (Kidder 1940:453). They may be a highly localized development of a monolithic idea spreading up the isthmus from northern South-America (Richardson 1940:415-416). This type of "alter ego" motif and the modified monolithic shaft would tend to support this suggestion. The Chontales sculptures fit more readily into the southern complex than do the classical Chorotegan carvings. Bas relief applied to the monolithic shaft, textile representation, position of the arms, objects held in the hand, and other minor details are common to both Chontales and northwestern South America. Although it is by no means conclusive that these two sculptural horizons in Nicaragua are a direct result of southern impetus, one is forced to accept that possibility (Richardson 1940:415-416).

As early as the 1880's, Thomas Belt suggested that the statues were not idols but "portrait-statues of famous chieftains" (Chapman 1958:73).

In general, the archaeology suggests the "Mesoamericanization" of the region between 800-1200 A.D. beginning with the Chorotega and intensified with the Nicaraos; the northern influences supplanted and/or blended with the predominantly southern (Chibchan) groups already in Guanacaste and the Nicaraguan lakes region, and those which migrated from the south at roughly the same time as the Nahuats-Pipils.

Nacascolo reflects contact with more than one culture and reveals a geographic situation very important in the commercial exchange from at least the end of the 8th century until conquest (Stone 1966:4). Based upon additional evidence presented above, Nacascolo was most likely part of an exchange network from very early times.

The proper names Chorotega, Corobici etc. are not actual names of different cultures, but rather, result from the 16th century Spanish tradition of naming a group after its cacique, and thinking that each cacique represented a different culture (Ferrero 1981:56). The significance of this, is that the earlier cultural remains

at Nacascolo represent an "archaeological culture group" and are not necessarily the ancestors of any of the ethnographic cultures living in the region at contact. This must be remembered when attempting to assign the Nacascolo remains to any particular culture, and especially when using ethnohistoric materials for interpretive purposes.

Early Subsistence

Problems pertinent to subsistence continue to perplex archaeologists. Studies have emphasized hunting-gathering adaptations, arboraculture, and vegeculture vs. seed-culture vs. marine subsistence; while none of the studies are conclusive in themselves, and at times raise more questions than they answer, they do provide pieces to the Precolumbian subsistence puzzle.

Maize has been used to support the hypothesis of Mesoamerican influence in the area. Maize is also part of Circum-Caribbean (Steward 1948) and Tropical Forest subsistence traditions, with importance varying according to local traditions (Lange 1971b:51). Some maize, as well as varieties of tubers, were almost certainly grown by shifting agriculture with variable levels of importance in overall dietary patterns in different portions of the

Greater Nicoya region (Lange 1971b:51). Norweb (1961:27) commented on the considerable variation in subsistence patterns from region to region throughout the temporal sequence. He attributes this to a difference in local natural resources, or perhaps, to an inherent difference in cultural tradition.

Lange's (1971b) theory is that the Greater Nicoya share characteristics of Circum-Caribbean affiliation. He argues that the tropical forest provided an abundance of wild game, and natural resources including wood and other vegetal products, and a wide variety of hallucinogenic and narcotic plants, that were important in ritual, and perhaps served a basis for regional and long distance trade (Lange 1984:42). Lange (1971a:270) refers to Greater Nicoya Middle Polychrome Period sites as having a "Sedentary Gatherer pattern of organization."

Both agriculture and marine exploitation of Culebra Bay and estuaries were part of prehistoric food-getting activities, yet the exact role of agriculture remains somewhat obscure. A number of people have analyzed flora and faunal remains in attempts to understand subsistence activities. Data pertinent to the subsistence around Culebra Bay have been undertaken by Moreau (1983), Kerbis (1980), Pallant (1981), Love (1986), and Lawrence (1989).

Maritza Gutierrez G. of the MNCR is currently examining over 8000 faunal remains from Nacascolo. Her identification and analysis should provide pertinent insights into prehistoric subsistence at Nacascolo; she has also pointed out several types of animals, represented in the beach cemetery, which are not found in Nacascolo faunal remains outside of mortuary contexts. This perhaps, indicates a distinction between animal use as subsistence, and animal ceremonialism as expressions of religious beliefs. This is discussed more thoroughly in Chapter 4..

Arboraculture was very important in contact times (Lange 1971b:53). Oviedo referred to Nicaragua as "Mohammeds paradise," and mentions "tree gardens" which probably had a long tradition (1851:55:4:12). Although difficult to define archaeologically, fruits, nuts, and berries were apparently part of subsistence activities. Lange (1971b:53) suggests acorn (Quercus oleoides) exploitation, similar to that described for many California Indians. He bases this on a number of milling bins, ground in volcanic bedrock, found during his Sapoa River survey. He believes that milling bins and "nutting stones" are similar to those found in large quantities at some sites in California, and associated with acorn technology (Greenwood 1969). Similar milling bins have been identified at Sitio Cascabel, on the northern

hillside overlooking Nacascolo (Piedra y Hardy 1980).

Interestingly, the word nacascolo is of Mexican origin nascatli, meaning ear (Incer 1985:439); it is said that this nut resembles an ear. Nacascolo is a hard wood tree (Caesalpinia coriacea), and there is some evidence to suggest that a type of ink was obtained from its fruit (Perez Valle 1976:90).

In Maya subsistence, Puleston (1982) demonstrated the importance of the breadnut or ramon (Brosimum alicastrum). And the fruit from the guanacaste tree (Enterolobium cyclocarpum) was considered a 'famine food' (Marcus 1982:251). It is also possible that pejibaye (Guilielma gasipaes Bailey or Bactris gasipes HBK), of southern derivation and a significant staple today, played an important role in precolumbian subsistence (Stone 1966:218; Sweeney 1975:55; Lange 1976:50). Ethnohistoric sources for the Chorotega and Nicarao report that corn, beans and squash, among other things, were prominent. Yet despite the evidence for subsistence practices of the Nicarao and Chorotega, these sources tell us little of subsistence practices for the extinct archaeological cultures. We must look elsewhere for information concerning subsistence activities at that time.

Archaeological evidence, excavated from La Ceiba (Guerrero and Blanco 1987) support the ethnohistoric sources. Floral evidence derived from from vessels and ovens in mortuary contexts indicate an array of agricultural products including corn (Zea mays), beans (Phaseolus vulgaris), palm (Oribignya), avocado (Persea americana), and zapote (Pouteria sp). At Nacascolo, corn (Zea mays) has been found in the earliest cultural levels (Lawrence 1989).

Turning to subsistence influences from South America, the cultural, botanical, archaeologic and linguistic data allowed Chapman to hypothesize that early Chibchan migrants came to Central America as early as the third millennium B.C. bringing with them a sweet manioc tropical forest culture (Chapman 1958:167).

Comparative linguistics indicate that the northern Chibchan languages of Central America separated from the western South America protostock a few thousand years before the Christian era, and the Hokan-Jicaque probably separated from its proto stock in the north at a comparable, if somewhat later, date (Chapman 1958:167).

The Hokan-Jicaque probably came as hunters and gathers, and some time after their arrival in Central

America, the Hokan became assimilated into the Chibchan tropical forest culture. By the time of the conquest some of the early Chibchan the Xinca and the Lenca had become partially acculturated to their Mesoamerican neighbors whereas, due to their relative isolation, the other Chibchan, the Paya, Sumu, Matagalpa, and the Hokan-Jicaque retained the ancient tropical forest culture (Chapman 1958).

Artifact Assemblages as Evidence of Subsistence Practices

While hunting, fishing, and agriculture were important food getting economies, a debate continues among archaeologists as to the degree each of these subsistence activities were practiced. Early subsistence hypotheses were based on ethnohistoric data. Archaeological data used to substantiate particular subsistence practices are often unavailable, inconclusive, or blatantly inaccurate. For example, Love (1986) draws conclusions based on insufficient data. The empirical study upon which Love bases her column study (Treganza and Cook 1948), recommends 15 column samples from each site. Love examined nine columns samples from six sites; she did not attempt palynological study. Love ignores the artifactual evidence for agriculture, citing a 10 year old source that stressed the scarcity of agricultural indicators (Lange

1976:50). Lange's statement may have been a correct assessment based on the archaeological evidence at that time, but certainly, this should not have been cited by Love in 1986 to support her predominantly marine-based subsistence theory. Evidence does not support her hypothesis, to the contrary, archaeological excavations have increased artifact assemblages indicative of agriculture; and palynological analysis leave little doubt these people were agriculturists (see Hardy 1983; Guerrero and Blanco 1987; Lawrence 1989; and Chapter 5, Artifact Descriptions).

Agricultural practices are often derived from artifact assemblages, particularly stone. Throughout Guanacaste/Nicoya, stone tools conform to the general definition of small scale agriculture (Voorhies 1978; Lange 1978). However, the high concentration of metates in northwest Costa Rica, found primarily in mortuary contexts, has instigated a controversy regarding the metates function.

Although traditionally considered grinding stones for maize, it is possible that these may have been ceremonial seats rather than metates. This theory was first espoused by Lothrop (1926), and has been defended by Norweb (1961), Lange (1971b), and Graham (1981).

Much of the archaeological evidence cited in support of this theory comes from mortuary contexts at Las Guacas (AKA Las Huacas), and that excavated by Hartman (1907) during one short field season in 1903. Among the myriad grave offerings, sixteen metates were recovered from an hypothesized sixteen graves (one to three in some, none in others). One clay figurine, of a mother and child seated on a metate, was also recovered from one of the graves (Hartman 1907:20 fig.13) No manos were found associated with the metates, and this, according to Lange (1971b:51), casts doubt on their inclusion as grinding implements for use in another world.

Hartman returned to Las Guacas the following year to continue excavating the cemetery but the site had been severely looted in the interim. Many cemetery metates had been used to construct the walls of a large oven for sugar-manufacturing (Hartman 1907:39). A "low estimate" of the number of metates removed during Hartman's absence was calculated over two thousand (Hartman 1907:39).. Hartman observed the excavation of over 50 metates, none were accompanied by "rubbing stones" (manos).

The number of metates found at Las Huacas contrasts dramatically with mortuary evidence from other sites within the region. It is therefore somewhat confusing

how, the special purpose metate is, at the same time, considered a standard grave offering of common occurrence. This phenomenon will be discussed more thoroughly in the Comparisons section of Chapter 6.

Archaeological evidence supportive of the "seat" theory, include a number of clay figurines, from northwestern Costa Rica, which depict figures seated on metates, such as the one described above. Furthermore, archaeologists have stressed the fact that many of the metates are elaborately carved, and often found unaccompanied by manos, thus evidence of their "special purpose."

The designation of metates as ceremonial seats, rather than subsistence indicators, is thought consistent with other indicators of Circum-Caribbean influence (Lange 1971b). According to Rouse (1948a:525), the Arawak carved stools made of wood (Plate 87:J,L) and stone. These were common among people of higher class, and were used during religious ceremonies; Arawak chiefs were buried with the stools they had used in life (Rouse 1948a:532). The Carib are also reported to make stools (Rouse 1948b:555). These are not described as high class objects per se, but their dead are placed upon stools in the grave (Rouse 1948b:559). Among the Guayupe, ceremonial stools play an

important role in the transition of leadership from the deceased headman to the legitimate successor (Kirchoff 1948b:387-88).

The Paya and Northern Sumo "occasionally use elaborately carved metates and well-made manos obtained at ancient ruins," and "three-legged wooden stools were formerly richly carved, often having a bird head" (Kirchoff 1948a:224). Oviedo used the word "duho" in describing a slightly concave, four-legged wood stool, that was being used as a pillow by the Tecoatega cacique, Agateyte (1976:461-462).

Many of the Nicoya/Guanacaste metates evidence wear, which led Snarskis (1981) to develop a somewhat different interpretation for metates. He postulates that metates were used to grind substances during ritual activities. This he bases on finding two decorated metates and associated overhang manos in mortuary contexts from Nacascolo. Although Snarskis is mistaken in his understanding of the metates association (only one of these two metates was accompanied by a mano), at least he recognizes some type of grinding function. These metates differ from those of Snarskis's Atlantic watershed and Central Highlands, which are larger, more elaborate flying panel metates, with rich iconographic depictions of

raptors, felines, and saurans. They represent the artistic pinnacle of metate craftsmanship.

Ryder (1983) synthesized the archaeological evidence for the spatial and chronological contexts of metates. He suggests the essence of ceremonial or special purpose metates, is food processing implements (Ryder 1983:194). The iconography suggests shamanic powers and access to esoteric knowledge, thus providing the owner socially acknowledged status (Ryder 1983:194-195).

There can be little doubt that metates, like many of the stone tools recovered from the Nacascolo beach cemetery, have multiple functions. Regardless of how they are used, or what they are called, these wood or stone ceremonial stools are similar to Costa Rican metates, with carved ornamentation, three or four legs, sometimes with an effigy animal head, and a tail (Lange 1971b:50). They cannot however, be thought of exclusively as seats or grinding stones. Their function, as well as their value, is determined by the social group and the extenuating relationships and circumstances which brought the object into the group.

To date, only one palnological study has evaluated Nacascolo (Lawrence 1989). His data suggests the

possibility that the lower, moist, estuary fringe, was partially cleared for agricultural activities (Lawrence 1989:74). Maize is particularly well adapted to cultivation in clayey, wet soils, such as those found in river bottoms, and the outer fringe of the estuary at Nacascolo. Pollen preservation within the estuary soil environment at Nacascolo is marginal for archaeological purposes, but Lawrence's study, nonetheless, provides the first unequivocal evidence for maize (Zea mays). This was obtained from one of the lowest levels of Nacascolo (Lawrence 1989:73). Lawrence suggests that the combined effects of intensive land use, and ecological consequences of seed-crop agriculture, contributed to the depopulation of Nacascolo in the Late Polychrome Period. He suggests the people entered Nacascolo as agriculturists and adapted to marine environment. The Nacascolo mortuary data indicate this also.

To account for a large quantity of carbon in the soil, Lawrence hypothesizes possible prehispanic salt production in the Nacascolo estuary, in which large quantities of wood are burned. Saltmaking is evidenced at Salinas, in the valleys of Puerto Culebra, and Panama (Bonilla, Calvo and Salgado 1986). Excavations have not however, produced conclusive evidence for salt production at Nacascolo. However, the quantity of ovens observed in

excavations throughout the site, bespeaks something other than mere cooking. Particularly interesting are a number of ovens with a dense concentration of crude-ware sherds (Feature 13). This was encountered within centimeters of the surface in the beach cemetery, and will be discussed in Chapter 4.

Among Lowland Caribbean groups, salt was procured from two sources: the bark of a coco palm and from sea water. In both cases the salt was extracted by boiling the ingredients in a large pot, the pot was then broken to obtain the salt (Espino as cited by Chapman 1958:101)

Notwithstanding the aside taken above, manos and metates diminish in popularity in northwest Costa Rica and southern Nicaragua during the late Early and Middle Polychrome periods. This corresponds with an increase in marine exploitation. By the Middle Polychrome Period, the frequency of notched sherds and net-sinkers increases, suggesting fishing with nets. Deer and fish bones also become more pronounced. Both these occurrences indicate a greater reliance on natural resources than during the preceding Early Polychrome Period. The artifact assemblages lack an evolved fishing technology, but this may reflect poor preservation. Negative evidence does not necessarily mean activities did not take place but that

the technology employed perishable materials such as wood or plant fibers. Fishhooks are absent from the archaeological materials suggesting fishing was limited to netting close to shore on the bays, in the rivers, lakes, and in tidal estuaries, although schools of pelagic fish apparently frequent shorelines with some regularity (Maritza Gutierrez, personal communication). Evidence of a fish trap has been found along the northern coast of Nacascolo (Vazquez and Gutierrez, personal communication), but has yet to be described in detail. Marine mollusca were exploited along the Costa Rican coast with increasing intensity from Early Polychrome times on whereas there is little evidence for this practice in Zoned Bichrome sites. As an economic consideration, dried fish and/or shellfish could have been traded inland, along with salt, and purple dye made from Murex sp.. Tobacco (Nicotiana sp.) and cacao (Theobroma cacao), were most likely part of an exchange system as well, for they are reported as important in commercial trade around Rivas (Healy 1981:5).

All things considered, it is best to view pre-columbian subsistence activities as broad-spectrum. Given this, it is felt that mortuary remains spanning several cultural phases, as evidenced in the Nacascolo cemeteries, will shed light on adaptive practices as suggested through artifactual remains comprising ritual

activities and mortuary behavior. Palynological analysis of soil contained within ceramic vessels may clarify both agricultural activities and precolumbian beliefs; it may be demonstrated that what was placed inside a vessel holds greater significance than a vessel as grave offering. Conversely, as Day (1984) has suggested, vessel iconography transcends its utilitarian function in demonstrating and/or transmitting aspects of the belief system. Aspects of the precolumbian belief system are found in the next chapter. Before then, however, this chapter concludes with a short discussion of precolumbian social organization.

Social Organization

Basic Circum-Caribbean society was stratified into three or four classes: chief, nobles, commoners and slaves (Steward 1948:3). There are hierarchies within each status as well, for example, the Cabecars distinguish three types of shamans (Bozzoli de Wille 1979). There was no organized priesthood with the exception of the shaman. Some social status was hereditary, and some positions were attained by personal prowess. Warfare affected the hierarchy in elevating some individuals and reducing others to prisoners of war, slavery, or sacrificial victims. Wealth (Steward 1948:3) and esoteric knowledge

(Helms 1979) were major factors in the status of chiefs and nobles. Oviedo noted that among Chibchan groups of Columbia, some local caciques were more important than others, the lesser subordinate to the more powerful (Broadbent 1964:17). It is evident that sites within Costa Rica were hierarchical as well.

In Columbia and Central America, titles and property tended to pass along matrilineal lines, from a man to his nephew, and in some cases, matrilineal clans were interwoven with social class (Steward 1948).

Among lowland Caribbean tribes, three types of leadership were recognized: a council of elders, a temporary war chief, and a medicine man (Chapman 1958:120). The council of elders, usually comprising several old men, governed the communal affairs, as well as organizing the cooperative work, arbitrated disputes, appointed war chiefs in times of need, and so forth (Chapman 1958:120). Among the Paya and Jicaque such wise men were known as "saurines." Among the Sumo and Miskito, elders are referred to as "old men" (Chapman 1958:120).

I now turn to discuss aspects of the belief system pertinent to our understanding of the precolumbian peoples of Guanacaste/Nicoya.

Chapter 2

PRECOLUMBIAN RELIGIOUS BELIEFS

As mentioned previously, Greater Nicoya shares cultural traits with both Mesoamerica and South America. It is likely that these regions share general religious beliefs as well, albeit that of Guanacaste/Nicoya would presumably be a hybridized system influenced from both directions and adapted to suit their needs; and that these beliefs would be manifest in ritual activities and symbolized in the iconography portrayed in the artifact assemblages. Religious beliefs symbolized in artifact iconography is discussed in Chapter 4. This chapter details precolumbian religious beliefs and practices derived from ethnohistoric and ethnographic sources; archaeological data are mentioned when warranted.

Mesoamerican influences are clearly evidenced in Middle and Late Polychrome Period sites throughout the study area, and suggest religious beliefs involving an essentially mesoamerican belief system. While this may be true for the later occupants of Nacascolo, this does not however, illuminate the type of beliefs held by earlier peoples of Guanacaste/Nicoya. In accordance with South American cultures, unlike their Maya neighbors, no written

records or other direct evidence documenting religious life, mythologies, and other sacred oral traditions exist for the early precolumbian inhabitants of Nacascalco, but archaeologists obtain information in this area from ethnographic and ethnohistoric analogy. One can through analogy, attribute esthetic, religious, or magical ideas to identifiable objects. The same may be said for customs associated with funeral ritual, which by definition is religious behavior. Religious activities comprise part of the information process of human societies, the information conveyed through ritual. These rituals often conceptualize aspects of subsistence. The function of religion may be seen as a culturally integrating and binding device which provides order in a confusing and often frightening world. Religion also promotes, legitimizes, and perpetuates a social hierarchy based on knowledge and power (Maddox 1923); thus begins a "masking effect" of social inequality (Hodder 1982).

The problems and limitations associated with the use of analogy and ethnographic materials make questionable the validity of applying data gathered from groups far removed temporally or spatially from the early inhabitants of Nacascalco. However, certain underlying concepts of religious beliefs permeate the style of mortuary remains. The, style or particular way of doing things, highly

embedded in the cognitive and cultural matrix of makers and users, allows the enactment and elaboration of daily life (Sackett, personal communication). The careful use of analogous data therefore, "adds a sense of discovery to sheer, aesthetic appreciation" (Wilbert, personal communication).

Although spatially and temporally separated, Central and South American ethnographies are important for they often portray cultures sharing similar beliefs and continuous lifestyles into historic times and, quite possibly, they are more representative of the early Nacascolenos than the social organization found among the Nicarao and Chorotega in historic times, and certainly less religiously complex than the Maya. At contact, the Nicarao and Chorotega were similar in their religious practices: both had temples, raised sacrificial mounds, idols, both practiced human sacrifice, cannibalism, and auto-sacrifice.

The earliest precolumbian cultures were most likely governed by shamanic principles. A brief investigation into the shamanic belief system provides essential background to the interpretations of the material remains associated with funerary behavior.

Shamanic Origins

Lacking an understanding of natural causation, early man most likely believed his misfortunes were due to outside agencies and ascribed his bad luck to the ghosts and spirits known to exist in dreams (Maddox 1923). Through dreams another world was represented - a separate world which duplicated the known world. Belief in this world, as an act of faith, implies the origin of religion. When awake, the demons and spirits disappeared, only to return in later dreams. Therefore, (in early man's reasoning), the souls of the dead must still be alive, nearby, and venting their spite on the living residents. They would have to be propitiated and manipulated to ensure all went well in everyday life. To control the relationship between the two worlds requires a specialist, hence, the necessity and evolution of the shaman (Maddox 1923:21).

Shamanic concepts and tools originated in the Old World and were carried to the New World by Paleo-Asiatic peoples migrating across the Bering Strait land bridge many millennia ago. The dates are highly debatable, but what is important, is that these people brought with them a shamanic belief system which easily adapted to varying ecological conditions in the New World (Le Barre 1970).

Without a written language, knowledge is passed on by oral tradition; sacred beliefs were preserved in songs and dance, and displayed during ceremonies. This ritual knowledge was not held equally by everyone in the community, but known in detail only by the culture bearers, shamans and other knowledgeable people. Music, dancing, and smoking were not recreational activities, as they are today, but rather fulfilled a far more significant need involving rituals geared toward manipulating the world and maintaining balance and control. Especially powerful was ritual knowledge, for one was able to supplicate the dead, as well as see and manipulate the future. Those with the most power were usually shamans as they were the leaders in religious ceremonies geared toward group protection from drought, storm, disease, death, and spirits. They were the most respected and most feared members of the community.

Shamanic Principles

The shamanic belief system is complex and based on the concept of power. Power is knowledge, having the correct understanding of the ways of the world, and the belief that one must behave in a certain way to maintain that power. Power is acquired, usually through dreams and

or visions induced by deprivation or psychotropic plants (Furst 1976). Power is individualized, not transferable. Everyone sharing in this belief system receives and loses power, the goal is to maintain equilibrium. Without power one is helpless, but with restraint and intelligent use of power one is successful. In this belief system anything sacred, mysterious, or of wonderful power or efficacy is referred to as "medicine." "Medicine," in the shamans sense includes clairvoyance, ecstacism, spiritism, divination, demonology, prophecy, necromancy, and all things incomprehensible (Maddox 1923:24-25).

Shamanic initiation usually involves the notion of a divine call often by trance, ecstasy, or dreams, possibly induced by psychotropic plants; there may be hereditary transmission of shamanism, or a personal quest, occasionally willed by the clan (Eliade 1958:87). The "estatic" instruction (e.g. dreams, visions, trances) is followed by traditional instruction in shamanic techniques, names and functions of the spirits, and mythology and genealogy of the clan. This knowledge is imparted by spirits and old master shamans (Eliade 1958:8). Often there is something peculiar in the physical and/or mental appearance of the shaman; abnormalities were seen as spirit possessions or marks of distinction which set that person apart from the rest of

the group (Maddox 1923).

In addition to mental and physical peculiarities, real or feigned, the shaman knows how to emphasize dissimilarities between himself and his fellow-men which strengthen the esteem in which he is held by the people, thus confirming and fortifying his position, The shaman's faith is generally real and cannot be shaken for they believe that they have spoken to the gods face to face, have heard their voice, and felt their presence (Maddox 1923:108). The special regard and fear aroused by the shaman unite in making for him a unique place in the social group (Maddox 1923:124). No single factor has more potently influenced the culture and shaped the destiny of society than the shaman (Maddox 1923:291).

"...in consideration of the social control which he has exercised, and in consideration of the fact that art, education, history, and science have their incipiency in the class to which he and his fellows belong, whether consciously or unconsciously, the shaman has rendered a social service, the beneficial results of which are incalculable" (Maddox 1923:292).

Part of shamanic belief system include "power objects." In the shamanic world everything is animate. Through ethnographic analogy to shaman tool kits in Peru, these power objects have been identified as bone tubes, enigmatic stones, pipes and the smoking of tobacco, and

other substances in curing, musical instruments, and effigies. These objects, usually manipulated in some manner, insured the individual's well-being. Stone (1958:25) identifies "snuffing and the playing of flutes by medicine men" as southern traits. In the Atlantic watershed of Costa Rica, shamans are identified in stone "sukia" figures (Stone 1958:25; Ferrero 1981, 1989:83). Among Columbian groups, the shaman transforms into a bird and guides the souls of the dead to the beyond (Reichel-Dolmatoff 1988:36).

The Cabecars of Talamanca distinguish three kinds of shamans: the first, known as usekoL, is the chief; the second, awa' is a curer; and the third, itsokoL, is the principal singer at funerals (Bozzoli de Wille 1979).

Pre Columbian Drug Use

Few doubt precolumbian use of many plants known for their psychotropic properties. Inhalation of narcotic powders and tobacco through snuffing tubes is well documented throughout South America. Among the Maya, ingestion by enema appears to be a widespread and ancient custom. It is often difficult to determine exactly what was being snuffed, because the paraphernalia and powders are similar, and because of conflicting, confusing, vague

terminology used by early chroniclers and ethnographers (Wassen and Holmstedt 1963). Among the myriad substances recorded ethnographically among South American groups, Cojoba, (Piptadenia cebil) has been described in the Atacama region, and (Piptadenia peregrina) use among certain Amazonian tribes (Ryden 1944:190-191). Throughout South America, the gastrointestinal (chewing, drinking, licking, rectal) and respiratory (smoking, snuffing) ingestion of tobacco (Nicotiana sp.) have played important roles in magico-religious, medicinal, and recreational activities (Wilbert 1987). Among the Nicarao and Chorotega, historic sources detail the cultivation and smoking of tobacco in ceremonies including rituals involving human sacrifice, and as mortuary offerings (Oviedo y Valdes 1976:435-440). Tobacco, coca (Erythroxylum), and cojoba (Piptadenia sp.) are all known to have been grown in Costa Rica and it would not be unusual to find that all three were utilized in various rituals beginning in early times (Stone 1966b).

Objects identified as snuffing, or smoking paraphernalia have been found from Costa Rica through South America and include bone tubes, single or double, clay snuffers, small containers of bone, wood, and bamboo, and wooden tablets used for snuff-taking (Wassen 1965). Archaeologists have long noted these types of items were

frequently found in association, and consider that such items were used together (Uhle cited by Ryden 1944:188). Rectangular bone snuff tablets and bird bone tubes have been found at Huaca Prieta dating back as far as 1000 B.C. (Bird 1948:26), and are also common in archaeological collections of Chile (Ryden 1944). In Costa Rica, single and double clay tubes were reportedly found at Linea Vieja during construction of the first railroad, and similar clay nasal snuffers from the Reventazon region were probably used for inhaling "cojoba" (Piptadenia sp.) or tobacco (Stone 1958:16). Similar objects have been found among Guetar-culture (Wassen and Holmstedt 1963:23).

Sukias, the seated stone figures found in the Atlantic watershed of Costa Rica, and believed to be shamans, often hold, and appear to be sucking or blowing a flute, cigar, or tube (Ferrero 1981:201, Figure I-203; 1989:83, Figure 26). It is likely that additional examples of snuffing tubes, and/or other snuffing paraphernalia found in archaeological collections, have been misidentified as whistles.

In Columbia, jaguar motifs often adorn the snuff tablets of ancient chibchan speaking tribes (Reichel-Dolmatoff 1972:62). Among many tribes of the Orinoco Plains the jaguar is associated with shamanism (Reichel-

Dolmatoff 1972:60). In some cases the shaman can change himself into a jaguar. To the north, the jaguar motif is well represented in mesoamerican artifact assemblages from Formative times. The feline represents the natural life force which on a social level, has to be controlled if a moral order is to be preserved (Reichel-Dolmatoff 1972:62).

The jaguar motif is found in dispersed areas from the Olmec to San San Agustin to Chavin. This does not necessarily suggest direct diffusion or contact but, rather, evidences the remnants of an archaic shamanic substratum which runs through all the Americas (Furst 1972:67). Additional iconographic traditions are discussed in Chapters 4 and 5.

Nagualism

An important aspect of pre-columbian beliefs is "nagualism" or the notion that everyone has an alter-ego in animal form (Thompson 1970:167). Ethnographically, some Maya groups share the belief that their ancestors and lineage gods reside in a particular sacred place and they care for a corral of animals, one for each living person in the community. Cared for by the aides of the Toltilme'iletic (deified ancestors). If a person commits

some evil, his particular animal or nagual is released from the corral; this is dangerous because whatever befalls the animal befalls him. The nagual is returned to the corral when its "alter-ego" performs a propitiatory rite (Thompson 1970:314-315). Such propitiatory rites and, ritual offerings in general, form an underlying concept vital to understanding the basic precolumbian belief system, as well as providing insights into many archaeological remains found at Nacascolo. Archaeological examples of the alter-ego are represented in the stone alter-ego figures of Nacascolo, Ometepe Island, and San Agustin, Colombia, as described in Chapter 1.

Ritual Sacrifice

The archaeological and ethnographic evidence of ritual sacrifice is plentiful throughout precolumbian America. Among the Maya, almost every living thing, including humans, and many inanimate objects were offered in sacrifice (Thompson 1970:182). A list from Thompson provides an idea of the kinds of things sacrificed; offertory caches of jaguar bones one painted red, opossums, shrews, manatees, parrots, quail, pygmy owls, finch, fish and turtles, dogs, deer, turkeys, wild hogs, iguanas, squirrels, pumas, crocodiles, alligators, feathers, and insects; in addition to the faunal

offerings, flora offerings likewise played important roles in ritual sacrifice and include corn, copal, squash seeds, annatto (a red coloring from the fruit Bixa orella, often used to color cacao, stews, and human bodies particularly as a war paint; flowers, pine boughs and needles often smeared with turkey blood, branches or bark of habin (Ichthyomethia communis) the leaves of which are used in milpa rites; a mead made from fermented honey and balche tree bark (Lonchocarpus longistylus); other offerings include honey, wax, and "virgin water" collected from distant cenotes or cave drippings free from contamination, pottery vessels, blue pigment, textiles, jade or turquoise mosaic plaques and objects of jade, flint, obsidian, shell and bone, coral, pumice, stalagmites, iron pyrite mirrors, gold and carved wood, copal, and rubber (Thompson 1970:182-183).

Of paramount importance over the plethora of floral and faunal offerings and sacrifices was the ritual sacrifice of human beings. Human sacrifice was often followed by ritual cannibalism and, in addition to the practice of auto-sacrifice (bloodletting), were important aspects in precolumbian beliefs.

Human Sacrifice

Ethnographic and archaeologic evidence indicate human sacrifice was prevalent throughout Mexico, Mesoamerica, lower Central America, and South America; archaeologic evidence indicates human sacrifice an ancient custom going back to Formative times before the emergence of complex societies when these areas shared basic culture elements.

Historic sources for both the Chorotega and the Nicaraos report the practice of human sacrifice and the taking of heads. Human sacrifice was a central element in the Xipe Totec cult among Pipil-Nicaraos throughout Mesoamerica, and was often followed by the wearing of the victim's flayed skin by Xipe impersonators (Nicholson 1972:213; Fowler 1989:234). This ritual has been interpreted by Seler (1899) as symbolizing the annual renewal of the earth's vegetation at the beginning of the rainy season. Nicholson (1972:216) however, hypothesized that the Xipe cult was associated with tribal warfare, the enemy's skin worn as a trophy (Fowler 1989:234). The wearing of flayed human skins into battle is recorded by Oviedo for the Maribos of Nicaragua. Among the Coiba and Cueva of Panama, flayed trophy skins are filled with ash (Andagoya 1945:436 in Fowler 1989:234). However, the flaying and wearing of skins is not specifically mentioned

for Greater Nicoya.

Ritual human sacrifice among the Nicaraos included killing men, women, and children. The victims were prisoners of war or slaves bought in the market (Chapman 1960:58). Martir relates that some children were raised in the homes of nobles for the purpose of later sacrifice (Chapman 1960:58). These children held a special status which allowed them to walk freely through the towns, as heroes, every request for food or adornment granted (Chapman 1960:60).

Martir described human sacrifice among the Nicaraos which consisted of stretching the victim across a sacrificial stone and cutting out the heart (Chapman 1960:60). Decapitation was a frequent form of execution for prisoners of war. Arrow sacrifice was also practiced. Oviedo (1976:442) related that the Chorotega, living between the lakes of Nicaragua and Managua, threw human victims into volcanos as offerings to the fire god, and into water as sacrifices to the water god.

Sacrificed prisoners of war were buried without their heads, the heads were hung on branches of small trees grown specifically for this practice (Oviedo 1976:442).

According to Cereceda:

Every cacique had special trees cultivated in a garden near his residence, each bearing the name of a hostile country, and to whose branches the heads of sacrificed war prisoners are suspended. (Martyr D. Anghera 1912:dec.6, bk.6:229-230 as cited in Fowler 1989:245).

It is uncertain exactly what was done with the heads of slaves, they may have been hung with those of prisoners of war, or buried. The trophy head tree has been identified as functional equivalents of the Aztec tzompantli, or skull rack (Leon-Portola 1972:76; Fowler 1989:245).

Ritual Cannibalism

Closely related to human sacrifice, cannibalism often followed human sacrifice. The circumstance, type of victim (domestic vs. prisoner of war), and type of ceremony dictating whether or not the victim was eaten. Apparently some types of ceremonies necessitated consumption of the individual while other ceremonies required only the sacrifice; prisoners of war were sacrificed and eaten whereas children were sacrificed and buried but not eaten (Chapman 1960:59). In conflicting statements Oviedo says slaves bought in the market were eaten but according to Herrera and Gomara it was legal for

a father to sell his children and that these slaves were not eaten (Chapman 1960:59). Apparently some slaves were eaten while others were not. Foreigners who entered the market may have been eaten but this is not definitely known (Chapman 1960:59). If the victim was a woman, the priests did not eat the flesh, and common people could not eat important prisoners of war; this right was reserved for principal caciques (Chapman 1960:59. Martir described how human meat was distributed among the Nicaraos: the cacique was given the hands and feet; the heart went to the priests and their wives and children; the legs to nobles; and the rest cut into small pieces and given to others of the community (Chapman 1960:60).

According to Gomara, great dances and drunkenness with wine and smoke were part of ceremonies of human sacrifice and cannibalism (Chapman 1960:59). Among the Chorotega, special festivals were held three times a year in which humans were sacrificed; the victim was then eaten amidst orations, songs, and dances of the celebrants (Chapman 1960:87).

Oviedo (1976:435-440) described such a ceremony among the Chorotegas of Nicoya as celebrated on August 19, 1529, under the leadership of Nambi. The ritual was actually

celebrated over the course of several days.

Two hours before nightfall the chief Nambi was found in the plaza seated on a duho surrounded by 70 or 80 principals who drank chicha and smoked tobacco, rolled in leaves into a type of cigar called yapoquete. They continued drinking chicha and smoking and then began drinking cooked cacao, as they are accustomed to drink, from large glasses taking three or four sips and passing the glass to another, some were singing, they remained there more than half the night until they fell to the ground senseless, drunk, like skins. Then their wives, friends, and sons took them to their homes where they slept until midday.

The cacique, nobles, and majority of the people were painted and adorned with feathers for the occasion. In the plaza, women held hands and danced in a circle around the sacrificial mound. The men danced in another circle making four or five passes around the women. While they were dancing, other individuals passed among the dancers offering drinks, all becoming inebriated; this continued for four or five hours until the priest led the victim/s to the sacrificial altar. Dancing ceased, the victim stretched across the altar, the chest opened and the heart yanked out.

The first blood is sacrificed to the sun. Then the head is decapitated as well as the heads of four or five others, and the blood offered to idols and particular gods, smearing blood on the lips and faces...The victims bodies were then thrown from the mound to the ground, collected, and eaten in a sacred and precise way. (Oviedo y Valdes 1976:439).

At the moment of sacrifice, all the women give a great scream and rush to the mountains and forests, against their husbands and relatives wishes. Some of the women are persuaded to return, others return after promises of presents, and others return after the threat of punishment; however, the woman who runs farthest is praised (Oviedo 1976:439). Oviedo provides no explanation for why the women ran away or why she who ran farthest was praised.

The same day or the following day, large quantities of maize are placed around the sacrificial mound. First the priest, then the cacique, then nobles in turn, in hierarchal order, "puncture their tongues, ears, and genitals" with chert knives, the blood falling on the maize. The bloodied maize is then gathered, distributed, and eaten as something very beneficial (Oviedo 1976:439-440).

Among the Talamancan Lowland tribes, the Guetar had an organized priesthood and sacrificed human beings at every moon and at burial feasts (Johnson 1948:250).

Archaeological Evidence of Human Sacrifice

Sacrificed victims and mass sacrifices are often

readily identifiable archaeologically and examples are found from Mexico through Peru. Sacrifice through removal of the heart and decapitation was common among the Maya as well, and is depicted in Mayan sculpture at Izapa (Thompson 1970:178). Archaeologically, evidence of decapitation consists of primary individuals found without skulls or disarticulated skulls found with articulated vertebrae. In the Maya area, skulls have been found enclosed in vessels placed lip to lip (Thompson 1970:178). In the Popul Vuh, after a ritual sacrifice the victim was buried (Thompson 1970:179). Skeletal remains at Teotihuacan dating to the Classic period have been found with the hands bound behind their backs (Cowgill 1990). One mass sacrifice found at Miramar, Chiapas, included the skeletal remains of 24 individuals; many were perhaps clubbed to death, or their throats slit; three of the individuals were skulls only (Agrinier 1978:15-16).

Fowler (1989) notes that victims sacrificed in Maya area are often associated with structures and the dedication of a building. Wire (1972) on the other hand, considers primary burials in association with secondary remains (combination burial) as evidence that the primary individual was sacrificed at the time of the secondary individual's burial. Lothrop adheres to a similar sacrifice-accompaniment theory for at least two burials

encountered to the south of the study area at Venado Beach, Panama where both individual and large group (as many as fifty) burials have been recorded (Lothrop 1954:226). The two primary, tightly flexed individuals exhibited broken backs, just above the lumbar; in their arms was placed the secondary bundled remains (one bundle painted purple) of their masters (Lothrop 1954:229).

Lothrop describes positive evidence for sacrifice, mutilation, and suicide based on his and also Harte's excavations. He mentions disarticulated body parts, individuals with broken backs (mentioned above), or necks (readily detected by the abnormal position of the head), articulated individuals with missing limbs, and apparently "hacked" individuals (Lothrop 1954:232). Some of these remains are directly associated with primary flexed or extended individuals (Lothrop 1954:232). Mutilations consist of missing crania, jaws, arms, feet, tooth extraction, fingers cut off, isolated crania and other body parts. Several cases of finger amputation were encountered; some bones were placed in shells; three cases of finger bones were found inside skulls; and one burial cut in several pieces, the hand and finger bones separated and "scattered around the skull and around a disarticulated jaw with one ramus cut off. Small water worn pebbles also were scattered around bones in similar

fashion" (Lothrop 1954:232).

Sometimes the amputation/mutilation includes bone reuse or replacement. One individual's hands and forearms were in contact but one humerus was missing. A bone "spatula" possibly made of this humerus was found in the grave. Another burial was found with the arm cut off and replaced over the other arm (Lothrop 1954::232)

Lothrop described another burial excavated by Harte of an individual with severed legs, one at the knee and the other four inches below it; the bones infected pitted appearance indicate the man survived sometime after the amputation (Lothrop 1954:232).

Lothrop suggests that individuals found with their mouths's open (gasping for breath), and some with their fingers in their mouths, were buried alive (Lothrop 1954:229).

At Sitio Conte in Cocle' Province, also in Panama, bodies were found in ordered rows accompanying high status individuals. Harte apparently excavated a similar group at Venado Beach with fifteen flexed individuals placed in orderly rows (Lothrop 1954:229).

Human sacrifice and mutilations are depicted in Mojica and Moche ceramics of Peru (Donnan), and skeletal remains suggesting a massacre at Pacatnamu have been described by Verano (personal communication).

Beliefs Regarding Human Sacrifice

Humans are believed sacrificed for a variety of reasons. Lothrop indicates that those of Venado Beach were killed to accompany their masters in order to serve them in the next world (Lothrop 1954:234). Those found at Miramar are believed to have been sacrificed to the gods to end severe drought. The sacrificed victims found in the cenote at Chichen Itza are believed to have been victims of a rain-seeking cult (Thompson 1970:180). The victims were often children like their cousins of central Mexico. Apparently, the rain gods throughout Central America had a predilection for children, hence many were sacrificed (Thompson 1970:180). Thompson thinks this has something to do with the "virgin" quality of children and the importance of purity in ritual. Purity was manifest in water drippings from caves which were collected and used in ceremonies where purity was essential so as not to contaminate the ritual. Vessels were often placed in highly inaccessible or dangerous areas to collect this "virgin water" (Thompson 1970:184).

In precolumbian Costa Rica, human sacrifice and cannibalism is viewed as having social and magical value; it enhances the partakers social position within the group and, magical powers of the deceased are attained (Aguilar 1965). Within precolumbian Costa Rica raids took place to fill the needs of the trophy head cult, to obtain sacrificial victims for the secondary burial of caciques (Ferrero 1989:78), and to steal women. Such intertribal wars formed alliances, consolidated beliefs, and added to the prestige of the cacique and individuals (Ferrero 1989:78).

The widespread evidence for human sacrifice and cannibalism, as well as animal sacrifice, so prevalent throughout Mexico, Central America, and South America, indicates a very ancient tradition.

This discussion has so far demonstrated that many precolumbian practices recorded in historic times contain elements of an older basic culture. While complexity no doubt varied, on a general level, the people held beliefs concerning life and death and expressed those beliefs through ritual activities comprising mortuary practices. Archaeologic evidence of religious beliefs are plentiful in the study area but the reasons behind the expressions are less evident. Outside of the ritual activities

already described, little is known concerning other religious beliefs and no ethnographic sources exist for the archaeological cultures. Comparisons to southern groups, especially Chibcha speakers, of Costa Rica, Panama and Columbia, enrich the data base and enhance interpretations of archaeological remains; it is also more accurate to compare groups with similar social complexity and common language background.

Chorotega and Nicarao Mortuary Practices

Notwithstanding the discussion of cremation practice in Chapter 1, and the problems in attributing archaeological materials to ethnographic cultures, the following mortuary practices are reported for the Chorotega and Nicarao.. According to an informant of Bobadilla, Nicarao mortuary practices for children involved wrapping a child in a manta and burying him/her at the door of the house. Chiefs were cremated, having first been finely dressed with gold and a symbolic representation of their wealth. Their ashes were deposited in urns and buried in front of the their houses. Above the interment, ceramic figures were broken in order that the memory of that person remained for twenty or thirty days. The burial occasion was honored with dances so that the history and memory of passed things remained (Chapman 1960:62).

Lowland Caribbean Mortuary Practices

Historic sources indicate Lowland Caribbean tribes buried in at least two locations: 1) under floor dwellings which were later abandoned and 2) in cemeteries (Chapman 1958:132). Among the Miskito "a lodge or hut was built over the grave in the cemetery, thus giving the appearance of a 'city of the dead.' The corpse was frequently laid in a canoe which had been slit down the center to form a sort of coffin, or sometimes a canoe was placed upside down on top of the grave in the cemetery (Chapman 1958:133). In either a hut floor burial or a cemetery burial, the dead were inhumed with their personal belongings, tools or utensils. There is one report which states that the Miskito buried their dead with a miniature canoe and a dead dog (Chapman 1958:133). These were thought to assist the deceased in passing through the underworld, where he had to go in order to reach paradise beyond. Secondary burial was also practised among the Miskito, Sumu, and Ulwa (Chapman 1958:132). By contact times a curious mixture of precolumbian practices and Christianity are seen in burial practices according to Von Hagen (1943 as cited by Kirchoff 1948:226); such practices included a small wooden cross placed at the foot of the grave, "and a pot through which a hole is punched is laid at the head."

In his discussion of Caribbean Lowland tribes Kirchoff (1948:226) states that "personal belongings, food, and a dog are placed in the grave." He described a Mosquito woman who exhumed the bones of her husband and carried them around in a bag for a year, subsequently hanging them in the house (Kirchoff 1948:226).

The Sumo and Mosquito and possibly Paya believe, under certain conditions, a dead persons soul lingers around the house of the deceased and even occupies his former belongings, including domestic animals. For this reason these things must be destroyed...Protection from bad spirits and the dead is afforded by amulets and charms (Kirchoff 1948:228).

Mortuary Practices of Talamancan Indians

Among Talamancan Indian groups including the Cabecars and Bribris, the predominant mortuary practice consisted of secondary burial, the degree of ceremony dependant upon the status of the deceased (Gabb 1876; Bozzoli de Wille 1975); an individual of little consequence was prepared "as soon as possible" and carried off to the forest, whereas an important person was accorded preliminary ceremonies involving specific and elaborate treatment (Gabb 1876:497), as well as a greater

number of priests participating in the ritual (Gabb 1876:499). Gabb witnessed the mortuary procedure for unimportant people as well as the special treatment provided someone from a distinguished family, and the funeral feast for the chief Santiago (Gabb 1876:500). I recount first the procedure for the newly deceased (Gabb 1876:497-499:

He belonged to one of the distinguished families, an ancestor, perhaps his father, having been one of the leaders in the war with Tiribi, and he the heir to, and possessor of one of the few gold 'eagles,' or insignia of rank. He died in the night, and the next morning, the body being in his hammock, covered with a piece of bark cloth; all of the chicha, chocolate, and food that the poor people of the house could get together on short notice was prepared. A fire was lit, amidst singing, by twirling a pointed stick on the face of another. This was the sacred fire, which was communicated to a small heap of wood placed on one side of the house. This could be used for no purpose whatsoever. No ordinary fire could be lighted from it; not even could one use it to light his pipe. It must burn for nine days. In case of its accidentally going out before that time, it must be relighted in the same manner as at first; and at the end of that time, only a priest could extinguish it, and he only with a calabash of chocolate, and during, or at the end rather, of the suitable incantation.

The next step after lighting the fire, was for the master of ceremonies, appointed by mutual consent, to cause to be collected some small scrapings of a peculiar wood, called Palo Cacique by the Spaniards. It is a wood used only for walking sticks...He also obtained a large lump of cotton wool, some seeds of a species of pumpkin, and a small root of sweet yucca. All the male friends of the deceased present, seated themselves on low benches in a double line, facing each other, with another bench between. A part of the cotton spread out so as to make a bulk about the size of a man's hand, was placed in front of the principal person, who then began in a sing-song tone between a recitation and a chant to relate the merits and deeds of the their departed brother. As he proceeded, and mentioned for instance that he had planted much corn, he

laid carefully on the cotton a piece of shaving which he said was the 'planting stick' used in that operation...This lasted about an hour, until every tool or weapon he had ever used was represented by a little pile of seeds and shavings on the cotton. But he was a great man and his 'eagle' was not to be forgotten. A very rude imitation of it was cut out of the skin of the yucca roots and placed on top of all his other property, and then the edges of the cotton were doubled over making all into a ball. This was placed on his breast, next to his body, and he was thus armed and equipped with all he had used or owned in this world, ready for use in the other: and his heirs none the poorer.

His body was then enveloped in the piece of 'mastate' or bark cloth that he had used as a blanket. together with the hammock in which he swang. A quantity of 'plantillo' leaves, a leaf not unlike that of the plantain, but only half the size and much tougher, were placed on the ground, two or three deep. The bundle was laid on this, the edges of the leaf envelope, doubled over, and dexteriously tied by strips of bark string and the whole turned out a very respectable Egyptian mummy done in green. By means of three strings, this was swung under a pole, ten feet long, raised on the shoulders of two men, who trotted off unconcernedly to the woods a mile or so distant. They were accompanied by two or three more, accompanied with machetes.

The body remains in the woods for about a year, to allow for complete decomposition. During this time the family grows corn for chicha and raises a sufficient number of "animals, pigs, or beeves, according to the importance of the defunct" (Gabb 1876:499). The chief arranges the time for all to be ready and a special person called Bi-ka'-kra takes charge as "commissary and master of ceremonies." The host resigns all to him and becomes a guest, until all is over.

The burial bundle is reopened by another specially appointed person qualified for unclean work who cleans and rearranges the bones, and rebundles them in a package about two feet long, and wrapped in a cloth painted in such a way as to state the manner of death (Gabb 1876:500). The new bundle is then carried under a pole to the house where the feast is to be held, and placed out of the way on an overhead rack.

No final burial description is provided but Gabb relates that of Santiago.

The burial feast for Santiago lasted over two weeks and entailed the consumption of enormous quantities of food, chicha, and chocolate, singing, dancing, drum playing and, according to Gabb, general debauchery (Gabb 1876:501). The ceremony leader sings of the journey the deceased will travel to Si-bu, "where there are no troubles or cares" (Gabb 1876:504), and he will have nothing to do but eat, drink, sleep, and enjoy himself" (Gabb 1876:503).

Final disposal of Santiago was a matter of great care, and the whole tribe went to the district of Bri-Bri.

The receptacle is a square pit about four feet deep and ten feet square. This is paved on the bottom with stones, and is roofed over from the weather, by a series of heavy hewn slabs of very durable wood, open on the front and ends, and sloping to the ground at the back. Each family possesses one of these pits and here, after the funeral feast, the bundle of bones is carried and deposited...The remains of Santiago were carried to the 'royal pit' and deposited without further ceremony. (Gabb 1876:503).

According to Lyon (in Gabb), the Cabecars have about the same ceremony, but their pits are mere holes, not paved, and covered by planks laid on the ground level. The Tiribis have a death feast but it differs from the others; the body is buried immediately after death [primary burial?], no longer with the property of the deceased (Gabb 1876:503).

During the time the body lies in the woods decomposing the disembodied spirits prowl around, living on wild fruits. At the end of that time, the fire is kindled, attracting the spirit to the feast "whence it departs on its final journey" to Si-bu (Gabb 1876:503).

In general, there is great fear of the dead (Bozzoli de Wille 1975). The corpse is considered bu-ku-ru' or unclean (Gabb 1876:499). Only proper treatment and ritual prevent contamination and resultant death. The possessions of the deceased are also dangerous, and are

either buried with the deceased or destroyed; however, Gabb witnessed this custom change to dividing the defunct's possessions among the heirs (Gabb 1876:498). Gabb commented that in the procession to the final resting place of Santiago, "some chicha jars were carried out and ostentatiously broken; but I observed that nothing of real value was destroyed." (Gabb 1876:502).

Bozzoli de Wille's doctoral dissertation (1975) and subsequent publications (Bozzoli 1979) identified conceptual similarities between life and death represented in the belief system of the Bribris. Although these are contrasting categories from a natural viewpoint, Bribris culture defines them as equivilent categories (Bozzoli de Wille 1975:73). Both pregnancy and death involve aspects of uncleanliness, contamination, and danger which may only be avoided through proper behavior and ritual. Bozzoli (1975:73) suggests this equivilence stems from Bribris beliefs of "1) going back to the same place the soul originated and, 2) returning and remaining in a fetal or child-like form, as the soul had originally left." Functionally equivilent roles are seen for pregnant women and buriers as guardians of the doors of society. Additionally, functional equivilence exists in the concept of origin, as a seed, and the guarding of the deceased's

bones and the return of the soul to the earth (Bozzoli de Wille 1975:19-20).

Southern Concepts of the Realm of the Dead

Some Columbian Indians seem to believe that after dying physically the individual continues to exist in this world as a spirit and that only through time does he enter another dimension where he finally vanishes forever (Reichel-Dolmatoff 1988:36). This is an apparent belief in a limited continuity of the spirit of the dead but is no conception of immortality of the soul. Life continues in the grave but there is no life beyond the grave; the ancestors are ubiquitous and they continue to take part in the daily lives of the survivors (Reichel-Dolmatoff 1988:37). The idea that voices of ancestors or at least the voices of the more recently dead ones may be heard and that they transmit messages to the living is common among present day Columbian Indians (Reichel-Dolmatoff 1988::36-37). Cuna Indians, who place the deceased in a hammock and then bury them under the house, often refer to dead relatives as "living under the floor" (Reichel-Dolmatoff 1988:37).

The concept of a living corpse in which a body is preserved by mummification, then dressed, propped up

against a wall, and treated as though still alive, is a southern concept (Reichel-Dolmatoff 1988). According to Reichel-Dolmatoff there is a great deal of historic information on the subject and it points to a relationship between preserving the corpse or skull of an enemy.

Kogi Funerary Ritual

Reichel-Dolmatoff (1974), commenting on the tremendous loss of information regarding beliefs and burial ritual in archaeological remains, described a burial ceremony among the Kogi Indians, decedents of ancient Tairona, Chibchan speakers. Even though time and distance separate the Kogi from the Nacascolo inhabitants, their ritual should be reviewed because the Kogi are representative of similar social complexity, and the grave offerings described are also more similar to what I find in the Nacascolo cemetery than to burial practices described for other parts of Costa Rica and Mesoamerica.

Reichel-Dolmatoff distinguishes the different components of the burial ritual and analyses their function within the wider context of Kogi culture. Contrary to what a casual observer (or even experienced archaeologist) might view as a simple burial, is, in reality, a complex demonstration of Kogi world conception

based on directional orientation and points of reference with which they connect categories that are of importance to the individual, to society, to nature, and to the supernatural forces. It begins with a basic principle of dualism, of antagonistic but complementary pairs, the scheme develops into a four-fold structure, bidimensional, and fixed in space. A third dimension is then introduced, formulated in terms of above and below (Reichel-Dolmatoff 1974:299). All these aspects are necessary for maintaining balance in the universe. His example underscores the quantity and importance of burial ritual information lost in the archaeological record.

Even shells have symbolic meanings. Among the Kogi, ritual practices employ small marine shells as offerings or as personal amulets; bivalves represent the female principle while gastropods represent the male principle, both are offered to the Mother Goddess in order to increase fertility. The little shells, buried with the corpse represented the surviving members of the girls family, and the largest shell was a gastropod which symbolized a husband for the girl because if this was not included once in the Beyond she might ask for a husband and thus might cause the death of a young man of the tribe (Reichel-Dolmatoff 1974:299).

The Colorado Indians of Ecuador pay great respect to the dead. The corpse is interred, and a cord fastened to it extends from the grave to a neighboring tree. As long the cord remains attached, offerings are brought and the grave is visited daily. It is believed that the soul is still with the body; but when the cord is found to be broken through accident or decay, it is construed as a sign that the soul has departed for the realm of the Gods, and the visits and offerings cease (Seler 1886:122)

Maya Belief in the Afterlife

Turning to northern sources for evidence of religious beliefs, the Maya recognized three abodes of the dead; the underworld, final resting place of most persons; a paradise located in one of the heavens; a celestial home to which were admitted warriors who had died in battle or on the sacrificial block, and their female counterparts who had died in childbirth (Thompson 1970:300).

In Yucatec the word for underworld is "Metnal" the road to which is hazardous and lengthy; there are three gates to be passed and a lake to be crossed with the aid of dogs before the destination is reached (Pozas 1959:203 in Thompson 1970:300). The belief that dogs aid one to cross a body of water was widespread from the valley of

Mexico to central Honduras; it survives among other Tzotzil groups; the Tzeltzil and the Lacandon. This last group place a small palm figure to represent a dog at each corner of the burial mound, and these guard the soul on its last journey (Thompson 1970:300-301). Ancient Maya tombs have yielded skeletons of dogs and, in one instance, a flint carving of an alert dog (Thompson 1970:301). Dogs in mortuary contexts, and animal ceremonialism in general, is discussed in Chapter 4.

Considering the myriad beliefs detailing funerary practices, attempts to use them to explain aspects of the archaeological record are speculative at best. However, they do add an extra dimension to our understanding precolumbian life. Exact practices may not have taken place but examples are provided to demonstrate types of rituals that express overall general themes of the precolumbian belief system. This provides an opportunity to examine the material remains of such a society and describe aspects of their cultural history as expressed through manifestations preserved in the archaeological record.

Customs expressing religious rites and magic which help people cope with the vagaries of nature, have little tangible manifestation and are difficult to trace into the

prehistoric past. However, archaeological evidence demonstrate their existence. Presentation of mortuary data for the study area are found in Chapters 4 and 5. I now turn to the discussion of the methods employed in my mortuary analysis.

Chapter 3

METHODOLOGY AND DEFINITIONS

Theoretical perspectives governing interpretations of mortuary practices, mostly borrowed from socio-cultural studies, have been tested so much over the last twenty years, that they are generally accepted without much argument. Bartel (1982:32); Chapman (1977); Tainter (1978); and O'Shea (1984), have provided the most recent published syntheses of archaeological interpretations of mortuary practices; the incorporation of structuralist theory, and examination of death-related behavior within the context of the social group and its environs, assists recognition of cultural complexity.

Analysis of mortuary practices has been approached through representational schemes of the social organization such as demonstrated by Binford (1971) and Saxe (1970). Mortuary behavior has also been described as having a masking effect and interpreted as deception in masking social inequality (Hodder 1982). Binford presented a representational paradigm in which there exists a social persona of the deceased as well as obligations of the living. Mortuary practices are, after all, obligations of the living (Binford 1971), dependent

upon additional constraints such as time limitations and labor. This is never a perfect relation but an ideal relation based upon least effort and limited resources (Brown 1971).

The theoretical perspective governing this analysis is based on certain assumptions regarding mortuary practices. Primarily, that an individual's treatment at death is a direct reflection of the position occupied in the status system in life (Binford 1971). Drawing upon the terms of Goodenough (1965), Saxe (1970:4) states:

"When archaeologists excavate a set of burials they are not merely excavating individuals, but a coherent social personality who not only engaged in relationships with other social personalities but did so according to rules and structural slots dictated by the larger social system."

Following this: a "social identity" refers to a category of persona such as mother, policeman, professor, shaman etc. Two or more social identities engaged in a social relationship is referred to as an "identity relationship"; and finally, a composite of social identities is referred to as a "social persona" (Saxe 1970:7).

While it would appear that archaeologists consider deceased individuals decorated in their "social persona" awaiting identification, in practice this is often

difficult to ascertain. While Saxe's premise is clear, his explanation that "coherent social personalities" are identifiable assumes that grave goods associated with an individual are his possessions. In fact, as in the case of infants, certain high status grave offerings and symbols of authority, such as metates, should not necessarily be viewed as the infant's personal possessions, for they had no time to achieve such articles of high rank, but rather, were ascribed to them through kinship relations. Possession, therefore, often indicates social mechanisms involved in attaining social rank, be they through an achieved system based on age, sex, and personal achievement, or ascribed through birth, differential access to resources, or a combination of these.

Differential burial treatment should, therefore, reflect the type of social complexity involved: egalitarian non-ranked, non-stratified society vs ranked (Service 1962) and stratified societies (Fried 1960). Differential status within the former group is based on a division of labor through age and sex criteria; whereas, in the latter group, succession to status is usually dependent upon birth order (Fried 1960).

Within a ranked society, the framework of statuses

resembles a pyramidal ranking system in which the hierarchy represented has definite economic significance related to collection and redistribution (Fried 1960). This is accomplished through familial and sacred authority and does not entail political authority. The rank society has "strong status differentials which are marked by sumptuary specialization and ceremonial function" (Fried 1960:719). Rank society differs from stratified society in that the latter is distinguished by differential access to subsistence resources, and some kind of political authority to enforce and maintain differential access to these resources (Fried 1960). Thus, the emergence of complex societies is associated with a shift from prime authority based on kinship means to territorial means (Fried 1960:721).

Vertical distinctions, as mentioned in Chapter 1, may be ascertained archaeologically by variations in the amount of energy expended in the burial ritual. Costs are determined by the amount of corporate involvement, and are reflected in grave size and elaborateness of the interment, method of handling and disposal of the corpse, and the types and amount of grave offerings (Binford 1971, Wire 1972, Tainter 1975).

Questions concerning ownership may always be raised,

and the degree to which they are answerable, is dependent upon the adequacy of ethnographic data and preservation.

Ucko (1969) stressed the dangers of archaeological interpretation of mortuary data based on ethnographic analogy; an individual's wealth or status is not always represented in archaeological remains. Ucko's example of the Yoruba of Nigeria, where possessions of high status individuals are displayed at the funeral but taken away by priests of the same cult association and not interred, is a lesson for all who use ethnographic data for mortuary purposes. Similarly, his selected ethnographic cases underscore the fallacy of equating burial practices with belief in an afterlife; grave offerings should not necessarily imply use in the afterworld but are often the visible expression of the individual's social personality, "the visible expression of having left the living" (Ucko 1969:265).

Interment of grave offerings effectively removes the objects from the social group, thus reducing the fear of vengeful ancestors. Interment also limits the accumulation of wealth.

Social groups recognize certain conditions, such as unusual manner of death, which strain group identity and

solidarity within the contexts of their belief system. Saxe (1970:10-11) refers to this as 'deviance,' and defines this, in the sense that the deceased ("ego"), has "breached the rights/duties relationships with alter-egos and hence brings an end to normal reciprocity" through his or her abnormal lifestyle, manner of death, illness, or, perhaps crime. This often translates into a change in mortuary practice, to distinguish the 'deviant,' from other members of the group, by an alternate burial method. This having been accomplished, stabilizes the group.

Such an example underscores Ucko's (1969:263-264) emphasis that change in burial methods do not necessarily indicate, nor automatically necessitate, change in religious beliefs. Bartel (1982:52) succinctly summarizes the cohesive aspects inherent in deriving social structure from mortuary behavior:

"The general structure of mortuary practices within a given society entails a lengthy process, which is the result of interrelationships between physiological aspects of death and societal socioreligious behaviors."

Burial Definitions

Mortuary practices encountered in Guanacaste/Nicoya are defined through the following criteria. Standardized

terminology has been used in order to aid comparisons to other cemetery populations.

Inhumation: the practice of burial or concealing the body in the ground: an interment. Inhumation is a type of deposition but not all depositions are inhumations. For example, the deceased may be disposed on the surface (scaffold, trees etc.).

Primary burial: the interment of an articulated individual.

Secondary burial: (Ubelaker 1978:111): an interment of disarticulated bones.

Semiarticulation: (Bass 1972:43 cited in Sprague 1968:481) a condition in which part of the body is in anatomical order, a partial articulation. Bass describes "partial articulation" as very important, although difficult to observe archaeologically. Semiarticulated remains indicate a lapse of time between death and burial and provide a basis for estimating its duration.

Combination: a primary individual with secondary remains.

Cemetery (Sprague 1968:480): a special place devoted to inhumations, or, a repository for deceased individuals. This may be in a trash midden or an artificially built up mound with a structure built upon it, but the burials would still constitute a cemetery. By this definition, any grave site, regardless of the location or number of individuals interred, is considered a cemetery; purposeful inhumation or deposition therefore, constitutes a special place.

Adhering to terminology and definitions proposed by Sprague (1968:479-480), burials are considered either "simple" or "complex."

Simple disposal: involves utilizing only one mortuary method at one specific time and may include primary inhumation, surface disposal, or disposal in water.

Compound disposal: disposal entails two or more distinct stages of disposal processes; 1) the reduction process or processes and 2) the secondary or final disposal. The reduction process may include:

- 1) Burial and subsequent disinterment or exhumation,
- 2) exposure to air, 3) exposure to animals, 4)

mechanical defleshing, 5) cremation, and 6) artificial decomposition with chemicals. This then, in turn, is followed by the secondary disposal which includes the three forms listed under simple disposal, or it may involve a secondary reduction process, with a final disposal process as described above.

Regardless of the disposal method used, they both involve the psychological abandonment of the remains by those still living. Compound burial implies additional amounts of energy expended over simple interment, as well as certain beliefs regarding the social position of the dead.

Vehicles of disposal: pit, urn, stone cist tombs, rectangular stone lined pits, shaft tombs. No shaft tombs have been reported for the study area, however, considering the extensive shaft tomb complex to the north and south of the study area, a strong possibility for shaft tombs exists.

Body Position:

Terminology for burial position follows those defined by Sprague (1968), and Ubelaker (1978), and are based on reference to three anatomical components: (1) legs, (2)

arms, and (3) head. The terms "extended," "semiflexed," "flexed," and "tightly flexed" are applied to both upper and lower extremities.

Tightly flexed: legs (or arms) collapsed on top of body or squeezed tightly together.

Flexed: legs (or arms) at an angle less than 90 degrees to the body.

Semiflexed: legs (or arms) at an angle greater than 90 degrees to the body.

Extended: legs and arms have no flexure.

In determining specific body position knees are considered together, any variation to this is explained in terms of knees collapsed to the left, knees collapsed to the right knees spread apart. Abbreviations used to describe these positions include: FBL (individual on it's back, legs flexed to the left); FBR (same as above only legs flexed to the right; FL and FR (individual in flexed position on the right or left side); SFL or SFR (semiflexed position on right or left side; TF (tightly flexed); EXTS or EXTB (individual in extended position on it's stomach or back.

These terms are also applied to the arms, with each arm considered separately. Arm position falls into one of four categories (Ubelaker 1978:14): (1) extended beside the body, (2) crossed on the pelvis, (3) folded over the chest, and (4) raised toward the head; yet these are used synonymously arms raised toward face, flexed or tightly flexed depending upon the degree of flexure; arms at side (extended), arms under pelvis (semiflexed), arms across chest (flexed), arms across pelvis (semiflexed).

Finally, in defining cranial position, Sprague's (1968:482), suggestion of "looking," combined with a direction (ie: "looking right," "looking left," "looking straight ahead,") as well as the descriptive "chin compressed to the chest," are employed. Ubelaker's (1978:17) recommendation of applying a more anatomical position, for example "resting on right occipital" or "resting on left parietal" etc. are also used.

Orientation: is derived by the direction of the skull (and/or vertebral column) in relation to the azimuth of long axis of the skeleton. This is then recorded in terms of compass direction (degrees east of magnetic north), natural landmarks, cultural features, or combinations of these reference points.

Statistical Analysis of Mortuary Data

Multivariate analyses of mortuary practices are often used to classify data for purposes of social inference, such as demonstrated by Tainter (1975:82-83), who established that vertical differentiation in social systems is reflected archaeologically by variations in the amount of energy expended in mortuary ritual. Since vertical differentiation is readily apparent in Nacasclo mortuary practices: some individuals were placed in tombs in with many grave offerings, whereas others were placed in simple pits with no few or no grave offerings, complex statistical analysis was not deemed necessary. An attempt was made however, to quantify distinctions with bivariate crosstabulation in contingency tables using actual or observed frequencies without further statistical manipulation. Conversion to percentages was accomplished and distinctions among burials are obvious. Symbols of authority, wealth, and exotic items are few and easily recognized, statistical manipulation is unwarranted for their identification.

Since ceramic vessels are the most represented artifact assemblage found among the burials, I believe analysis of the number of ceramics associated with each

individual may distinguish hierarchical levels within the beach cemetery population; this complexity is then compared to other mortuary areas throughout the site and region.

This is, of course, a highly subjective assessment of grave offerings which have withstood the ravages of time. Many other offerings indicative of status undoubtedly were buried with the dead, and have not survived; these may include feathers, cloth, hides, basketry, and flora remains, not to mention the possibility that status was expressed through body painting. The archaeologist is therefore, relegated to examining artifact assemblages of more durable, yet, not necessarily more prestigious, nature. Notwithstanding this critical lacuna, this method of analysis, used in conjunction with recognized status objects, provides an accurate and comparable way of evaluating status and social complexity among precolumbian groups of northwest Costa Rica.

Having detailed the theoretical and methodological aspects underlying this analysis, I now turn to discussion of methods employed in excavating the Nacascolo beach cemetery.

Excavation Procedure

In addition to the excavation methods mentioned in Previous Archaeological Investigations at Nacascolo discussed in Chapter 1, this section briefly details the excavation methods, implemented by the author, in the beach cemetery during the 1988-89 field season (Hardy 1989).

All excavation units were dug in arbitrary 20cm. levels until cultural material was encountered. This usually consisted of concentrations of rocks, sherds, and/or shell. Excavation then followed natural stratigraphy to expose and define the feature. The sandy soil matrix does not allow recognition of individual burial pits, indeed the only soil distinctions were seen in features which were comprised of (among other things) burned soil, and natural hard-packed crushed shell/coral lenses deposited during sand-spit formation, long before the areas use as a cemetery. This hard-packed soil comprises the deepest level (approximately 1.5 - 2 meters b.S.) in many areas of the sand pit, and contrasts with the preceding softer and looser sand. Only one burial pit (Burial 94) was discernible, this due to its excavation into this hard-packed level and subsequent filling with

softer sand. Since burial pits were not recognized until concentrations of rocks, sherds, shell, burial offerings or skeletal remains were encountered, burials were often exposed by removing the non-cultural material surrounding the burial pit; leaving the burial pedestaled, this results in what might best be described as a negative burial excavation or inverted burial pit.

In general, all material comprising cultural features was bagged and transported to the MNCR for analyses (with the exception of large rocks of Feature 1 and those overlaying burials which were removed and then reburied when the excavations were refilled). Material collected from the arbitrary levels was separated according to stone, ceramic, bone, and shell. All diagnostic sherds (rims, supports, handles, appliques, and painted wares) were collected, analyzed and stored; a 10% sample of the non-diagnostic sherds has been saved for future use and the rest disposed. Soil, filling the ceramic vessels excavated during the 1988-89 field season, was saved, and samples removed for phytolith analysis. All stone, shell, and bone artifacts from the level bags were analyzed and are likewise curated in MNCR bodegas.

Cemetery Boundary Investigation

As previously mentioned, cemetery boundaries eluded archaeologists during the first two field seasons. In 1988, I developed a method of sampling the beach area, by a series of shovel test pits, to determine the cemetery's expanse. During previous cemetery excavations, it was noted that rocks, sometimes shell, and sherd concentrations, often characterized burial location. This was an important observation considering burial pits were not distinguishable. Such features were usually, but not always, encountered at depths of 50-60cm. It was believed that locating similar evidence would indicate the presence of burials, hence cemetery extension. During discussions with Juan Vicente Guerrero, Director of Archaeological Investigations (MNCR), of this sampling method, I referred to this observation with the statement "no hay piedras sin razon en la playa" (there are no rocks on the beach without reason). While this sounds somewhat absurd, it does appear that at least in the cemetery, rocks, shell, and sherds are deliberately placed and are not the result of natural deposition.

The boundary test consisted of a series of soundings, excavated by shovel, approximately 20-25 cm. in diameter,

placed approximately every 2 meters extending 50 meters to the north and south of OP.8 east-west baseline. This necessitated clearing the vegetation from the area around the OP.8 excavations, to expose the surface (Plate 8). At first, the clearing extended 20 meters north and south, but this was extended when evidence suggested the cemetery continued. From a datum located at the northwest corner of OP. 8I, wooden stakes were placed every 10 meters north and south for a distance of 50 meters, and along the east-west baseline 10 meters west into the mangrove swamp, then approximately 50 meters to the east towards the bay. From the 8I datum, the lines to be followed were named A,B,C etc., each pit was numbered, and the direction from the baseline was indicated by N, S, E, W respectively. Workmen then lined up along the north-south line, approximately 2 meters (2 paces) from each other, and sunk pits. If rocks, shell, or sherds were reached, the pit was halted, two paces more walked, and another pit sunk. When no such material was recovered, the hole was excavated to a depth of one meter to be sure it was culturally sterile. The contents of each pit were then examined, the depth noted, and the material bagged, labeled and stored.

The pits and their contents, were then mapped and the pattern analyzed. While the results of this boundary test

are somewhat inconclusive, interesting inferences may be drawn. Sterile test holes suggest east and west cemetery boundaries but many of those to the north and south contained material which met the criteria indicative of cemetery evidence, including a mojon found in a pit behind the Von Bailey house. It would appear then, that the beach cemetery extends in both these directions beyond the area of the test pits. Enough vegetation had already been cut and I could not justify additional removal which might upset the ecological balance of the sand spit. At the very least, the vegetation controls blowing sand and affords protection from the harsh winds; such negative affects were recognized within minutes of inclement winds which temporarily blinded excavators and halted excavations.

If, as the evidence indicates, the cemetery continues beyond the area of the test pits, the cemetery is immense. Construction workers have reported encountering skeletons during construction of the Von Bailey house. Dominican priests, who own the house at the southern end of Nacascolo, have excavated a number of burials near their house (personal communication; Stone #1439; Wing n.d.). Based on these observations, and this study, it is possible that the cemetery extends throughout the entire sand spit, and what has been excavated is indeed a small

portion.

The importance of this cemetery and its unknown expanse should be emphasized in cultural assessments provided to the proposed tourist project "Proyecto Papagayo," and its integrity maintained and protected as its loss would severely impact Costa Rica's cultural patrimony.

Reiterating, the remains of approximately 120 individuals representing both sexes and all age groups have been excavated from Nacascolo beach cemetery Op.8A-M. They provide pertinent information concerning social structure, organization, and demography, as well as provide insights into subsistence practices, religious beliefs and ideology, as evidenced by ritual treatment and associated grave offerings.

With this in mind, I proceed to Chapter 4, and detail the mortuary data derived from the Nacascolo beach cemetery (Op.8A-M).

Chapter 4

Determining Factors of Burial Analyses

This chapter evaluates burials and cultural features comprising mortuary behavior from the Nacascolo beach cemetery (Op.8A-M). The reader is referred to Appendix I for complete burial descriptions and skeletal analyses, as well as Figure 1.6 (in back envelope) for locations of burials and features. Analyses of grave offerings will follow in Chapter 5.

Chronologic assessments for each burial are based on associated ceramics and established chronologies, burial position, and radiocarbon dates. Discussion of cemetery chronology and problems with dating the burials are provided in the section entitled "Dating the Cemetery," this chapter.

Bone preservation is notoriously poor in the tropics. This fact underscores the importance of the Nacascolo data and the overall good condition of the skeletal population. However, calcareous concretions (Plate 9a) cover many osseous remains and artifacts making identification, sex, age, and paleopathologic assessments difficult. While calcareous concretions are removable with a solution of

acetic acid and the patience of Job, temporal considerations prohibited removal except in limited instances. Root disturbances (Plate 9b,c) and the burrowing activities of rodents, land crabs, even iguanas, as well as digging by collectors, and inclement weather (Plate 10) all contribute to differential bone preservation within the cemetery, sometimes within the same burial. This is not an unusual phenomenon with skeletal remains and one which has been noted by Hoopes (1980:35,40) in burial data from La Guinea site.

Ageing, Sexing, and paleopathological assessments have been determined by physical anthropologists John Verano, Ph.D, of the Smithsonian Institution and member of the 1981 Nacascolo field crew, and Ricardo Vázquez L., Lic., physical anthropologist, Ph.D candidate (Suny-Albany), and MNCR Archaeologist during the 1980-1981 excavations. Vázquez also analyzed the Nacascolo skeletal remains from the author's 1988-89 field season. The remains constitute the oldest, one of the largest, best preserved and most representative skeletal populations found to date in Costa Rica. Criteria for determining sex and age are noted in each burial description of Appendix I. Subadult age is determined by bone ossification, tooth eruption, and epiphyseal closure. Adult ageing depends on degenerative aspects of the skeleton and the degree of

expression of those aspects. These include cranial suture closure, dental attrition, pubic symphysis morphology, and cortical bone remodelling. Due to visual limitations produced by calcareous concretions, differential bone preservation, and inability to correlate dental wear with ageing criteria, adult age was estimated within three broad categories (Verano 1982:2): Young Adult (20-34), Middle Adult (35-54), and Old Adult (55+).

Where possible, individual burials were aged more precisely, but for comparison, demographic reconstruction, and crosstab purposes, each burial has been assigned to an age sub-group 1-11; group 1 consists of old adults and infants are 11 (Figure 4.1). To simplify the age category of individuals who straddled age categories, I chose to place them into the nearest age category; hence, a mid-old adult was placed in group 2; those individuals "20 years +-" were considered adults; and a child 11-12 years was placed with the 12-15 yr. olds (group 8). Both Verano's original age categories and my sub-groups are provided throughout the discussion. Figure 4.2 lists the age and sex determinations for each burial from Op.8A-M. When unexcavated burials and redundant numbers are eliminated from the 113 burial records, a total of 106 excavated burials remain; this does not include the 6-15 individuals represented by secondary remains of Feature 18, which I

NACASCOLO BEACH CEMETERY SKELETAL POPULATION AGE GROUP
CATEGORIES AND SUB-GROUP DETERMINATIONS

AGE	SUB-GROUP	YEARS
Old Adult	1	55+
(Middle to Old)	2	
Middle Adult	3	35-55
(Young to Middle Adult)	4	
Young Adult	5	20-35
Adult of indeterminate age	6	
Sub-adults	7	16-19
	8	12-15
	9	8-11
	10	4-7
	11	0-3
	?	age unknown

Figure 4.1

NACASCOLE BEACH CEMETERY BURIALS (OP. 8A-M)

AGE SUB-GROUP	BUR#	SEX	POSITION	STRATIFICATION	ORIENTATION	
					North	
OLD ADULT 55 years+	55	F	Fseated	P/Group 2	308	
	77	F	TFB	P/Inclusive	180	
	25	H	FD	P/Intrusive/Grp.1	329	
	31	H	TFB	P/Inclusive	358	
	71	H	FBL	PD/Inclusive	92	
	43	H?	EXTB	PD/Inclusive	85	
	MIDDLE ADULT 35-54	57	F	FB	P/ Group 2	160
		105	F?	FBL	P/Inclusive	0
		53	H	SFL	P/Inclusive	68
		104	M?	TFB	P/Group 5	348
28		F	TFB	P/Inclusive	30	
34		F	SFR	P/Inclusive	170	
58		F	Skull	S/Group 2	7	
73		F	TFB	P/Inclusive	210	
108		F	FR	P/Inclusive	350	
83		F	FB	P/Inclusive	270	
11		F?	FBL	PD/Inclusive	0	
46		F?	FBL	P/Inclusive	40	
59		M	FBL	P/Group 2	20	
106		M	FBL	P/Inclusive	0	
76		M	FBR	P/Intrusive/Group 3	90	
96		H	Fseated	P/Inclusive	36	
112		H	TFB	P/Inclusive	80	
110		H	TFB	P/Inclusive	90	
81		M?	EXTS	P/Inclusive	320	
4		?	TFB	PD/Bur.3	290	
23	?	FB	PF/D/Bur.22	45		
26	?	EXTB	P/Intrusive	90		
YOUNG ADULT 20-34	61	F	EXTS	P/Inclusive	90	
	56	F	TFBL	P/Group 2	210	
	90	M?	TFBL	PD/Inclusive	0	
	17	F	FBL	P/Inclusive	288	
	67	F	FL	P/Inclusive	180	
	94	F	TFBL	P/Inclusive	20	
	102	F	FBL	P/Inclusive	4	
	60	F?	SB	SB/Group 22	7	
	91	F?	TFR	P/Inclusive	252	
	92	F?	DD	DD/Bur.87	7	
	5	M	TFB	P/Inclusive	90	
	44	M	FB	P/Intrusive or Grp 27	60	
	66	M	EXTS	P/Inclusive	278	
	54	M	EXTS	P/Inclusive	0	
	85	M	FR	P/Inclusive	180	
	111	M?	EXTS	P/Inclusive	198	
	84	M?	EXTS	PD/Bur.98	280	
	1	?	Back	P/Group 1	340	
	14	?	Back	PD/Inclusive	90	
	20	?	SKULL	SSkull/Bur.26	7	
22	?	EXTB?	FR/D	260		
ADULT 20-?	39	F	FBL	P/Dis/Inclusive	52	
	47	M	TFB	P/Inclusive	175	
	33	M?	FBL	P/Inclusive	270	
	7	?	FBL	P/Intrusive	200	
	30	?	FBR	P/Group 4	180	
	32	?	EXTB	P/Intrusive	126	
SUBADULTS Adolescents 16-19	74	F	TFBL	P/Dis/Group 3	125	
	3	F	EXTB	P/Intrusive	276	
	36	F?	EXTB	P/Intrusive	80	
	82	M	EXTS	P/Inclusive	162	
	68	H	EXTS	P/Inclusive	165	
	69	H	EXTB	P/Inclusive	290	
	103	M	TFB	P/Group 5	340	
	80	?	DD	SD	?	
	12-15	79	?	EXTS	P/Dis/Inclusive	40
		8	?	EXTS	P/Dis/Inclusive	40



ADULT	5	66	H	EXTS	P/Inclusive	278
20-?	5	54	H	EXTS	P/Inclusive	0
	5	85	H	FR	P/Inclusive	180
	5	111	H	EXTS	P/Inclusive	198
	5	84	M?	EXTS	P/Bur.98	280
	5	1	?	Back	P/Group 1	340
	5	14	?	Back	P/Inclusive	90
	5	20	?	SKULL	SSkull/Eur.26	?
	5	22	?	EXTB?	FR/D	260
ADULT	6	39	F	FBL	P/Dis/Inclusive	52
20-?	6	47	M?	TFB	P/Inclusive	175
	6	33	M?	FBL	P/Inclusive	270
	6	7	?	FBL	P/Inclusive	200
	6	30	?	FDR	P/Group 4	180
	6	32	?	EXTB	P/Inclusive	126
SUBADULTS	7	74	F	TFBL	P/Dis/Group 3	125
Adolescents	7	3	F?	EXTB	P/Inclusive	276
16-19	7	36	H	EXTS	P/Inclusive	80
	7	82	H	EXTS	P/Inclusive	162
	7	68	H	EXTS	P/Inclusive	165
	7	69	H	EXTS	P/Inclusive	290
	7	103	M	TFB	P/Group 5	340
	7	80	?	DD	SD	?
12-15	8	79	?	EXTS	P/Dis/Inclusive	40
	8	95	?	FR	P/Inclusive/Bur.80	174
	8	50	?	TFBL	P/Inclusive	265
	8	38	?	TFB	P/Inclusive	250
	8	75	?	FR	P/Dis/Group 3	255
8-11	9	NONE				
4-7	10	21	?	SKULL	SS/Bur.26	?
	10	24	?	FB	FR/D	320
	10	65	?	TFB?		?
	10	16	?	SFR?	P/Inclusive	272
	10	64	?	FB	P/Group 2?	NE
	10	70	?	FL	P/Inclusive	180
INFANTS	11	2	?	FB	P/Group 1	10
0-3	11	29	?	?	P/Group 1	31
	11	13a	?	?	P?	320
	11	13b	?	?	P?	?
	11	51	?	FBR	P/Inclusive	90
	11	52	?	?	P/Inclusive	90
	11	72	?	?	P/Dis/Inclusive	0
	11	109	?	?	P/Dis/Inclusive	90
	11	18a	?	?	P/Group 4	?
	11	18b	?	Skull	P?FR/Group 4	?
	11	19	?	SFL?	P/Inclusive	90
	11	49	?	PU	PU/Inclusive	?
	11	88	?	FL	P/Inclusive	200
	11	91	?	?	P/Inclusive	316
	11	45	?	PF	DD	?
	11	48	?	PU	PU/Inclusive	?
	11	86	?	F?	P/Inclusive	90
	11	87	?	EXT?	P/Inclusive/Bur.92e	190
	11	97	?	?	P/Inclusive	280
	11	107	?	?	DD	?
	11	113	?	SU	SU/Bur 112	?
	11	35	?	EXTB	PD	70
	11	98	?	FRags	FR/Intrusive	?
	11	99	?	FR?	P/Dis/Inclusive	?
	11	100	?	EXT?	P/Inclusive	190
	11	101	?	FR	P/Inclusive	90
	11	41	?	Skull	SS/Inclusive	328
UNKNOWN	6	bone scatter			FR/DD	?
AGE	8	1 long bone			FR/DD	?
	9	EXT?			FR/DD	?
	10	4 long bones			DD	?
	15	3 bone frags.			FR/DD	?
BURIALS	12	left in wall unexcavated				
NOT	27	skull in wall unexcavated				
COUNTED	37	left in wall unexcavated				
	40	redundant number				
	42	left in wall unexcavated				
	62	left in wall unexcavated				
	53	redundant number				
	78	unexcavated				
	89	no burial 89				

Fig. 4.2

TOTAL NUMBER OF BURIALS: 115
TOTAL NUMBER OF EXCAVATED BURIALS: 106
(redundant numbers and unexcavated burials not included)

SEX:
F-female M-male
F?-possible female M?-possible male

POSITION AND STRATIFICATION:
P-primary fragmentary remains PU-primary urn
S-secondary SU-secondary urn
Skull (S)-skull only SB-secondary bundle
Dis-articulated D-disturbed DB-disarticulated disturbed
TFB (L,R)-flexed on back, legs left or right
FB (L,R)-flexed on back, legs left or right
EXTS-extended on stomach EXTB-extended on back





discuss later, and I do not include these secondary remains in demographics.

Demography

The Nacascolo beach cemetery burial population is assumed representative of the living population in that all age categories of adults and subadults are present, as well as an approximate 50:50 male/female ratio among identifiable adults. A representative sample allows assessments of mortality figures which are indicators of the general health of the population. The overall mortality pattern for the Nacascolo beach cemetery skeletal population be seen in (Figures 4.3, 4.4). These charts indicate approximately 57% of all individuals reached adulthood (55 of 106), and average life expectancy was about 29 years. This mortality rate is nearly identical to that reported for the Middle Polychrome period cemetery at Los Angeles, Ometepe Island. According to Fleishhacker (1972; translation R.Lange):

The relatively large number of child and youth burials (45%), and a median age of death of 20-30 years old among adults and the lack of old skeletons leads to a general conclusion of a time with a high child mortality rate and a low average life expectancy.

Figure 4.5 compares adult demography per age category

NACASCOLO BEACH CEMETERY OP.8A-M SKELETAL POPULATION
AGE AND SEX DISTRIBUTION

TOTAL	SEX	?	F	F?	M	M?	
OLD ADULT (55+)		0	2	0	3	1	6
MIDDLE ADULT (35-54)		3	7	3	6	3	22
YOUNG ADULT (20-34)		4	6	3	6	2	21
ADULTS (age?)		3	1	2	0	0	6
SUB-ADULTS							
16-19		1	2	1	4	0	8
12-15		5					5
8-11		0					0
4-7		6					6
0-3		27					27
?		5	0	0	0	0	5
TOTAL		54	18	9	19	6	106
Adult Population:	55	52%	* Total:		F: 16	F?: 8	
Sub-adults:	46	43.3%			M: 15	M?: 6	
Unknown:	5	4.7%			?: 10		
Total:	106	100%					

* Sex of Adolescents not included in this talley

Figure 4.3

NACASCOLO BEACH CEMETERY OP.8A-M
MORTALITY FIGURES PER AGE SUB-GROUP

	FEMALE	FEMALE?	MALE	MALE?	?	TOTAL	
	1	2	0	3	1	0	6
	2	1	1	1	1	0	4
S	3	6	2	5	2	3	18
U	4	2	0	0	1	0	3
B	5	4	3	6	1	4	18
G	6	1	2	0	0	3	6
R	7	2	1	4	0	1	8
O	8					5	5
U	9					0	0
P	10					6	6
	11					27	27
	?					5	5
TOTAL:	18	9	19	6	54	106	

Percentage of adults per sex including 16-19 year olds:
(N=63)

Females: 28.6	Females?: 14.3	
Males: 30.1	Males?: 9.5	Unknown: 17.5

Figure 4.4 Number of individuals per age sub-group.
Note the minor differences between age sub-groups and the general age categories of Figure 4.3.

DEMOGRAPHIC COMPARISON OF ADULTS PER AGE CATEGORY AND
SUB-GROUP NACASCOLO OP.8A-M

N=55	SEX	F	F?	M	M?	?	TOTAL	%
OLD ADULT		2	0	3	1	0	6	10.9
%		33.3		50	16.7			
GROUP 1		2	0	3	1	0	6	10.9
%		33.3		50	16.7			
GROUP 2		1	1	1	1	0	4	7.3
%		25	25	25	25			
MIDDLE ADULT		7	3	6	3	3	22	40
%		32	13.6	27.2	13.6	13.6		
GROUP 3		6	2	5	2	3	18	32.7
%		33.3	11.1	27.7	11.1	16.6		
GROUP 4		2	0	0	1	0	3	5.5
%		66.6			33.3			
YOUNG ADULT		6	3	6	2	4	21	38.2
%		28.6	14.3	28.6	9.5	19		
GROUP 5		4	3	6	1	4	18	32.7
%		22.2	16.6	33.3	5.5	22.2		
ADULT (AGE?)		1	2	0	0	3	6	10.9
%		16.7	33.3			50		
GROUP 6		1	2	0	0	3	6	10.9
%		16.7	33.3			50		

Figure 4.5

and age sub-group. While this chart suggests an overall uniform death rate among females and males, it appears males lived somewhat longer than females. It is possible, that the percentage of unsexed individuals could balance this apparent inequality in life expectancy. In non-industrialized societies, deaths of women of child-bearing age often outnumber men; however, warfare takes its toll on males.

The representative demography of Nacascolo beach cemetery population, differs from the apparent restricted access demonstrated at Vidor, where predominantly subadults and females were recovered, and Los Angeles, where Fleishhacker reports a heavy proportion of males (about 6:1).

Subadult mortality is listed in Figure 4.6 and indicates 58.7% of subadults died before their third birthday. Figure 4.7 compares the Nacascolo subadult population with that of the Vidor site. Verano's assessment of Nacascolo skeletal material (1982) determined that the juvenile mortality pattern indicates a juvenile population suffering from chronic nutritional stress, possibly the result of iron deficiency anemia, which had significant and probably cumulative consequences throughout the developmental years. This hypothesis

COMPARISON OF NACASCOLO OP.8A-M SUB-ADULTS

AGE AT DEATH (Years)	NACASCOLO No. of Burials	PERCENTAGE
0-3	27	58.7
4-7	6	13
8-11	0	0
12-15	5	10.9
16-19	8	17.4
TOTAL:	46	100

Figure 4.6 Nacascoco sub-adult mortality figures.

COMPARISON OF NACASCOLO AND VIDOR SUB-ADULTS

AGE AT DEATH Years	NACASCOLO		VIDOR	
	Burials	%	Burials	%
0-2.5	27	56.25	52	40.3
2.5-6	3	6.25	39	30.2
6-14	8	16.7	36	27.9
14-20	10	20.8	2	1.6
TOTAL:	48	100	129	100

Note: Vázquez and Weaver's (1980) age group categories are used to facilitate comparison between Nacasclo and Vidor; hence the number of sub-adults (50) is greater than the number derived from the Nacasclo OP.8A-M comparison (45).

Figure 4.7 Comparison of sub-adults from Nacasclo and Vidor sites.

compares favorably and supports that postulated for children at Vidor (Weaver and Vázquez 1980), as well as for Los Angeles, Ometepe. At the latter site, corroborating dental evidence indicates rachitis, or other serious infections, plagued the islanders since youth (Fleishhacker 1972).

Burials

Burial deposition include individual primary flexed and extended individuals, secondary burials and isolated disarticulated remains, combination burials, and multiple or group burials. Variations in flexed position cross-cut age and sex categories and include individuals placed on their backs in tightly flexed position (Plate 11), legs flexed to the right or left side (Plate 12), flexed on right or left side (Plate 13), semiflexed on left or right side (Plate 14a), and extended position prone and supine (Plate 15). Three exceptions to these positions are found; an individual placed on its back in an extended position, the legs tightly flexed to the pelvis (Burial 83: Plate 15b); and two individuals (Burials 55, and 96) found in flexed, slightly upright (seated) position. Burial 55 is further differentiated by her feet pulled up to the pelvis, knees separated, hands resting on groin area.

Some infants, but not all (4 of 25), were placed into urns before burial; both articulated and secondary remains are found. The burial urn is not restricted to any particular vessel shape or ceramic type, ranging from a large globular olla to a Leon Punctate tripod dish (that some call chili graters). Infant burial urns are found inverted (Plate 16) as well as right side up and capped by a second vessel (Plates 17). Burial 49 was placed in a Yayal Brown olla with the neck and rim removed; a Carrillo ray effigy vessel (Plate 17a) was placed upright, capping the burial urn. Both vessels were burned; the burial urn evidencing carbon on both exterior and interior surfaces of the vessel (Plate 17b), the Carrillo vessel burned on the bottom exterior. The burial record makes no mention of the bones evidencing cremation. Some infants in burial urns at the Vidor site were found between two layers of ash however, there is no mention of burned human bones in any burial record or skeletal analysis of Weaver and Vázquez (1980). While it is apparent that ritual burning plays a role in mortuary practices, the procedure followed, and the reasons behind it, are unknown.

Spatial Organization

The general spatial organization of the beach cemetery does not indicate restricted areas based on age or sex; individuals of both sexes and all ages are interred throughout the cemetery. However, proximity and demography often suggest familial relationships or attempts to identify a person with a prestigious individual. This is particularly well evidenced in group or multiple burials. A group, as defined here, is two or more individuals in physical contact with, or in the immediate vicinity of another (within approximately 30 cm.), and is the result of either contemporaneous or a series of successive depositions, both of which are distinguishable to a certain degree. Groups cannot be comprised only of disassociated or disturbed fragmentary remains. By this definition Burials 6, 20, 21, 22, 26 (Plate 24), although in proximity would not constitute a group. Groups due to subsequent interment are evidenced by Burials 1, 2, 25 and 29 (Group 1, Plate 18a), and Burials 74, 75 and 76 (Group 3, Plate 19b); There are several examples of contemporaneous deposition: Burials 30, 18a,b; Burials 103, 104, 109 (Plate 18b); and the most striking (Group 2) comprised of Burials 55, 56, 57, 58, 59 (Plate 19a) and possibly 60 and 44 (see Appendix I: Burial 55).

The demography of Group 2 (Plate 20) consists of one old adult, female (Bur.55); one mid-adult, female (Bur.57) with a secondary, mid adult, female cranium (Bur.58); one mid-adult, male? (Bur.59); one young adult, male (Bur.44); and the secondary "bundled" remains of a female?, 18-25 years (Bur.60). The secondary bundled burial is in proximity to the rest of this group, contemporaneous deposition however, is uncertain due to the secondary nature of the remains (Plate 21), this burial may in fact, be intrusive. Burial 44, on the other hand, was placed on top of Artifacts 194 and 195, which were located against the right parietal of Burial 55 and chest of Burial 56 (Art.194); and Art. 195 rests over the left mandible and left shoulder of Burial 55, and over the right hand of Burial 56. Considering neither Burial 55 or 56 evidences disturbance, it is likely the young adult, male, was interred at the same time as 55 and 56. Similarly, proximity and lack of evidence indicating disturbance, suggests Burials 57, 58, and 59 were interred at the same time, for a group total of six individuals. Associated ceramics including Charco Black on Red, Guinea Incised, Juanilla Red on Buff date this group to the Mata de Uva Phase (300-500 A.D.).

While the demography of this group does not necessarily suggest family units, it is possible that some

of the individuals are related, perhaps mother, grandmother, sisters, brother and sister, possibly others, but this is not known for certain. No anomalies were found which might indicate genetic relationships. Based on the number of individuals and their unusual arrangement, this group must be considered unusual or, employing Saxe's (1970:10-11) term "deviant". Deviance from the norm often reflects illness or accidental death (Saxe 1970). One scenario, albeit speculative, involves an accident, possibly a drowning. The way several of the individuals appear to be looking at one another only adds to the mystery (Plate 20). Burial 56 is further differentiated from the other flexed individuals by her seated position, legs splayed. Regardless of the deviant nature of this group burial, with the exception of the secondary cranium (Burial 58), all individuals were provided grave offerings.

Another group (Burials 30, 18a,b) consists of an adult, sex undetermined, and two infants, possible twins, approximately 18 months old at death. It appears that the parent and children are buried together, most likely in a single interment episode. Another group of two infants (Burials 13a,b) was found in Op. 8a near Burial 31, an old adult, male; while the two infants are contemporary, it cannot be said for certain they are related to Burial 31.

Spatially, these three burials are closely related to Burials 3 and 4, but the latter are intrusive.

In addition to family units which may be evidenced in the spatial arrangement of some of the beach cemetery burials, there are at least two areas with concentrations of particular mortuary behaviors: 1) secondary remains (Feature 18), and 2) an area of infant burials mentioned previously.

Although infants were interred throughout the cemetery, there was a concentration of infant burials near the south-east corner of Op. 8F (Plates 16, 22) below the area where a plain tripod metate, ellipsoidal mano, and tubular jade bead were found (Artifacts 170, 171, 168 respectively), as well as a number of ceramic vessels. While excavating this area (Plates 16, 22); three or four individual infant burials were uncovered; their remains were few, small, and very fragile. We had just begun defining each burial when torrential rains covered the entire 8F pit with over a foot of water. When the rain subsided, an entire day was spent bailing water out of the pit and we were horrified to discover only two infant burials remained (Burials 51 and 52); the other infant remains had disappeared before they were adequately mapped and analyzed, the exact number of infants lost forever.

The number of high prestige grave offerings including a mano and metate and a jade bead are part of the burial fill; high status grave offerings such as these are usually reserved for individuals of great prestige, and it is somewhat unusual to find them associated with infants. Obviously the infants did not live long enough to achieve these offerings; rather, the grave offerings were ascribed to them at birth.

Another infant (Burial 48), was placed in an inverted urn (Artifact 118) and interred in this vicinity (Plate 16); over twenty-five infants were found throughout the cemetery indicating that the mortuary treatment accorded the infants in this area is different from that provided other infants who are found alone or with adults, both with and without grave offerings.

This supports an hypothesis that this area was of special significance in expressing aspects of precolumbian beliefs.

This area of infants in the beach cemetery differs from the infant burials found across the bay from Nacascolo at the Vidor site. At Vidor, a predominance of sub-adult burials and the exclusion of old adults has led investigators to suggest special and/or restricted access

burial areas. It is possible, and in light of the inclusion of infants throughout the Nacascolo beach cemetery, likely, that the excavated portion of the Vidor cemetery is but part of larger cemetery, and the subadult concentration representative of a specialized area within that cemetery. The smaller area of infant burials in Nacascolo beach cemetery dates to the Zoned Bichrome Period, whereas, the Vidor cemetery (depending upon which source is cited), is predominantly Middle Polychrome Period.

Secondary Remains and Mutilations

Several types of secondary remains are found in Nacascolo beach cemetery (Figure 4.8). The bundled burial (Burial 60:Plate 21) mentioned with Group Burial 2, is the only true secondary burial; the other secondary remains are skull burials, and other disarticulated and semiarticulated body parts. Secondary bundles are well recorded for the Intermediate Area, and are considered to be of southern influence. Secondary remains from Isla Venado (Sitio Regla), located in the Gulf of Nicoya, provide an example of the care, effort, and precision taken in composing the bundle (Plate 23).

Isla Venado is reachable only certain days of the

NACASCOLO BEACH CEMETERY (OP. 8A-M) DISARTICULATED SKELETAL REMAINS

<u>BURIAL#</u>	<u>SEX</u>	<u>AGE</u>	<u>ASSOCIATIONS</u>	<u>DISTURBED</u>
<u>SECONDARY BURIAL</u>				
60	F?	Yg. Adult		No
113	?	Infant	Bur. 112	No
80	?	Adult/Adol.		Yes
92	F?	Yg. Adult	Bur. 87	Yes
<u>SKULL BURIALS</u> <u>ATTACHED VERTEBRA</u>				
20	?	Yg. Adult	Bur. 26	No
21	?	5-9 yrs.	Bur. 26	No?
41	?	Infant?		No?
58	F	Mid. Adult	Group 2	No
<u>PRIMARY BURIALS</u> <u>VERTEBRA MISSING</u>				
39	?	Adult		No
79	M?	@ 15 yrs.		No
99	?	Infant		?
4	?	Mid. Adult	Bur. 3	Yes
74	F	17-20 yrs.	Group 3	No
71	M	Mid-Old Adult		?
Part of mandible in anatomical position, skull located 10cm. west of left leg.				
<u>PRIMARY BURIALS</u> <u>W/O SKULLS</u>				
26	?	Mid. Adult	Burs. 20, 21	No
68	M	17-19 yrs.		No
28	F	Mid. Adult	Bur. 16	No
84	M	@ 25 yrs.		Yes
74	F	17-20 yrs.	Group 3	No
79	M?	@ 15 yrs.		No
<u>OTHER BONES</u>				
26	?	Feet		No
68	M	Feet		No
28	F	Left hand		No
84	M	Left radius and Ulna		Yes
74	F	Cranium and left arm		No
79	M?	Cranium, right arm/left hand		No



skull located 10cm. west of left leg.

<u>PRIMARY BURIALS</u>	<u>MISSING</u>	<u>OTHER BONES</u>	<u>POSITION</u>	<u>SEX</u>	<u>AGE</u>	<u>ASSO.</u>	<u>INTRUSIVE</u>
	26		Feet	?	Mid. Adult	Burs.20,21	No
	68		Feet	M	17-19 yrs.		No
	28		Left hand	F	Mid. Adult	Bur.16	No
	84		Left radius and Ulna	M	@25 yrs.		Yes
	74		Cranium and left arm	F	17-20 yrs.	Group 3	No
	79		Cranium, right arm/left hand	M?	@15 yrs.		No

<u>PRIMARY BURIALS W/SECONDARY REMAINS</u>	<u>POSITION</u>	<u>SEX</u>	<u>AGE</u>	<u>ASSO.</u>	<u>INTRUSIVE</u>
57	FBR (Bur.58)	F	Old Adult	Group 2	No
75	FL Secondary cranium placed at feet, mandible placed on top of legs	?	11-12 yrs.	Group 3	Yes
76	FBR M Semiarticulated left arm placed between cranium and knees, probably obtained from Burial 74	M	Mid adult	Group 3	Yes
36	EXTB F? Two groups of cranial and pelvic bones placed on top of this individual	F?	Adolescent?		Yes
3	EXTB F Skull placed at feet (possible Bur.4)	F	@18 yrs.	Bur. 4	Yes
98	? Adult ulna, probably from Burial 84	?	Infant	Bur. 84	Yes

<u>BURIAL#</u>	<u>DESCRIPTION</u>	<u>DUE TO DISTURBANCE</u>
6	4 long bone frags/4 teeth	Uncertain
8	1 long bone	?
10	4 long bone frags	?
15	Few bone fragments	Probably
Burs.16/28	Hand bones inside Art.46	No
Bur.71	Maxilla of yg. adult inside Art. 223	No
Bur.39	8 adult teeth inside Art.120	No
Ft.18	(13 secondary groups)	Some Yes other's No

<u>SEMIARTICULATES</u>	<u>DESCRIPTION</u>	<u>ASSOCIATIONS</u>
"E"	Right radius and Ulna	Ft.18
76	Left arm associated with this burial, probably obtained from Burial 74.	Group 3

Figure 4.8 Disarticulated remains from Op.8A-M. Does not include secondary remains from Feature 18 (see Fig.4.9).



<u>PRIMARY BURIALS</u>	<u>POSITION</u>	<u>SEX</u>	<u>AGE</u>	<u>APP.</u>	<u>ASSOCIATION</u>
<u>W/SECONDARY</u>					
<u>REMAINS</u>					
57	FBR Skull (Bur.58)	F	Old Adult	Group 2	No
75	FL Secondary cranium placed at feet, mandible placed on top of legs	?	11-12 yrs.	Group 3	Yes
76	FBR Semiarticulated left arm placed between cranium and knees, probably obtained from Burial 74	M	Mid adult	Group 3	Yes
36	EXTB Two groups of cranial and pelvic bones placed on top of this individual	F?	Adolescent?		Yes
3	EXTB Skull placed at feet (possible Bur.4)	F	18 yrs.	Bur. 4	Yes
98	? Adult ulna, probably from Burial 84	?	Infant	Bur. 84	Yes

<u>BURIAL#</u>	<u>DESCRIPTION</u>	<u>DUE TO DISTURBANCE</u>
<u>ISOLATED BONE</u>		
6	4 long bone frags/4 teeth	Uncertain
8	1 long bone	?
10	4 long bone frags	?
15	Few bone fragments	Probably
Burs.16/28	Hand bones inside Art.46	No
Bur.71	Maxilla of yg. adult inside Art. 223	No
Bur.39	8 adult teeth inside Art.120	No
Ft.18	(13 secondary groups)	Some Yes other's No

<u>SEMIARTICULATES</u>	<u>DESCRIPTION</u>	<u>ASSOCIATIONS</u>
"E"	Right radius and Ulna	Ft.18
76	Left arm associated with this burial, probably obtained from Burial 74.	Group 3

Figure 4.8 Disarticulated remains from Op.8A-M. Does not include secondary remains from Feature 18 (see Fig.4.9).



year during low tides. Approximately 20 bundled secondary remains have been excavated by Juan Vicente Guerrero and others of the Museo Nacional de Costa Rica. The osseous remains are nearly pristine condition. One of the bundles contained the remains of one adult male and an infant, indicating an apparent familial relationship. One radiocarbon date has been obtained for this cemetery, 450 b.c. (Guerrero, personal communication). The island is an isolated, apparently specialized, burial area.

Returning to the Nacascolo beach cemetery, in addition to the bundled secondary remains of burial 60, we find skull burials, concentrations of disarticulated remains, semiarticulated remains, and individuals missing body parts including crania, arms, hands, and feet (Plates 24, 25, 26). As discussed in Chapter Two, these types of disarticulations and secondary remains are considered positive evidence for mutilation, and possibly, evidence for sacrifice (Lothrop 1954; Wire 1972; Fowler 1984, 1989).

According to the sources mentioned above, criteria indicative of human sacrifice, at least by decapitation, are met when crania are found with articulated cervical vertebrae or mandibles; when isolated skulls are found without articulated vertebrae or mandibles, they are

considered secondary burials.

Pre-Columbian depictions of decapitation in pictorial codices, figurines and stone carvings, as identified by Moser (1973:5-6), include a head or skull, in any position, with blood flowing from the neck, a head held by the hair and lacking a body, heads hung upside down, suspended by a chord through the cheeks, nostrils, etc., heads attached to poles, staffs, or used as body adornments, bodies with severed head, usually with serpents or blood projecting from the neck, portrays the completed or partial act of decapitation, and skull burials that retain the mandible and two or more cervical vertebrae but lack a body

While combination burials do not necessarily indicate human sacrifice there is evidence for human sacrifice, or at least mutilation, in the beach cemetery. Burial 79 (Plate 27), age 10-15 years, is missing its cranium, atlas and axis vertebrae, right arm and left hand. There was no evidence of subsequent intrusion which might explain the missing body parts.

One concentration of disarticulated bone groups were marked by darkened and burned soil, referred to as Feature 18 in 8J (Plate 28,29). The feature was first noticed at

approximately 75 cm., by a dark soil which differed from the surrounding lighter soil. It is roughly 1.5 meters in width and 2 meters in length with the darkened soil diminishing outwards. More or less in the center of this, is reddish burned soil. One fire-cracked, river-type cobble (Artifact 300, Plate 28) was found within the reddish soil, as well as what appears to be a shell flaked tool which bears a striking resemblance to a blade point (Artifact 301, Plate 28). Within the area of dark soil, although not restricted to the reddish burned area, were found thirteen secondary bone groups. They are randomly dispersed, horizontally and vertically, throughout the feature, and found between 105cm.-138cm. depth. No individual pits were distinguished. No bones evidence cut marks or having been burned. It is possible the feature, or parts of it, represents a single mortuary episode, although periodic mourning ceremonies should not be dismissed. Skeletal analysis of all bone groups may be found at the end of Appendix I. A short discussion of "Minimum Number of Individuals" is warranted here.

Minimum Number of Individuals

Minimum Number of Individuals (MNI) is used to measure the relative abundance of taxa found in archaeological sites. As defined by Shotwell (1959:272 in Hamblin 1984), MNI is "that number of individuals which

are necessary to account for all the skeletal elements (specimens) found at the site." This means separating the most abundant element of each species into right and left sides of the body, and then using the greater number as a unit of calculation. This sometimes introduces error on the conservative side since all lefts will not necessarily match all the rights. Examination of the bones before attempting to match them up alleviates this bias (Daly 1969; Flannery 1968; Grayson 1973; Bokonyi 1970, all cited in Hamblin 1984:15). Figure 4.9 lists the Feature 18 secondary remains and calculates the MNI represented as at least 5 persons and as many as 15. The majority of secondary remains found in Feature 18 suggest purposeful selection; almost all of the bone groups consist of the upper torso and arms. The only exception to this are bone groups E, F, and G. Skeletal analysis and spatial considerations of the semiarticulated remains including thoracic ribs, and arms, suggest these groups are the same individual, an adult male. If we accept these bone groups as the same individual, its disturbed condition may have been caused by the intrusive burial pit of Burial 102, and reburial of Burial "E"'s disturbed remains with Burial 102; or, "E" represents a purposeful disarticulation (mutilation?) to accompany Burial 102 (Plates 30, 31). This type of compound burial (disarticulated remains associated with a primary individual) is similar to one

NACASCOLO BEACH CEMETERY
FEATURE 18 SECONDARY BURIALS

	A	B	C	D	E	F	G	H	I	J	K	L	M
CRANIUM							X						
MAXILLA													
MANDIBLE						R/T			R/T			L/T	
VERTEBRA					X	X					X		X
CLAVICLE						L							
SCAPULA						L	X		L			X	
RIBS	X	X	X		X	X			X	X	X		X
HUMERUS				X		R	X	*			XX	R	
RADIUS	X	X	X		R	X			X	X	X		
ULNA	L		X		R	X					X		
METACARPALS					X	X					X		X
PELVIS					X			X					X
FEMUR						R	X	*				X	
TIBIA													
FIBULA									X				
METATARSALS					X			X	X				
UNIDENTIFIED									X				
AGE	AD?	A-AD	A-AD	AD	AD	AD	AD	AD	A-AD	?	1 A 1 AD	A-AD	A-AD
SEX	?	?	?	?	M?	M	M	?	?	?	1 F? 1 F	?	?
MNI					MAY BE SAME INDIVIDUAL				2 OR MORE		2 OR MORE		

NUMBER OF BONE GROUPS: 13
 NUMBER OF INDIVIDUALS REPRESENTED: 5-15

R=RIGHT L=LEFT T=TEETH
 * POSSIBLE HUMERUS or FEMUR
 AD=ADULT A=ADOLESCENT
 F=FEMALE M=MALE

Fig.4.9

described by Lothrop (1954) at Venado Beach, Panama. In light of Lothrop's description and interpretation of those mutilated remains, and considering the location of "E's" semiarticulated remains in an area of secondary remains, as well as the degree of "E's" semiarticulated remains, the latter explanation seems more likely.

Groups "J" and "M" may have been disturbed during the interment of Burial 101 (Plate 31). Evidence does not indicate however, that the other bone groups were disturbed by intrusive interments and other explanations must be sought if we are to understand the selective bone groupings.

Disturbance may also result from cultural practices including reburial of individuals and/or parts which were used in some type of mourning ceremonies.

It is possible that Feature 18 reflects a secondary disposal area, for burials encountered in other areas of the cemetery, which were cleared out to permit the interment of a more important individual; or perhaps, over time, burial location was forgotten, and burials were simply plowed through and the disturbed remains were reburied in an area of the cemetery specifically used for this type of reinterment. If these bone groups were the

remains of primary individuals which had been excavated to make room for something else and then reburied in what is now called Feature 18, I think a greater variety of human remains would be found and not only upper torso and arm remains. It is apparent these remains reflect selective practices; yet the reasons behind the selection are unknown. It may have something to do with acts of cannibalism which often play an important role in secondary burial practices (Goldstein 1986). Among the Nicaraos, ritual cannibalism often occurred after human sacrifice, the body parts distributed in specified manner (Oviedo 1976:439).

What types of indicators then, might be found to suggest such activities? Do the Nacascolo data evidence cannibalism? Cut marks have not been observed on the secondary remains although they could be hidden by calcareous concretions. What types of bone and pathology are found when cannibalism has taken place? Philip Newman, who has investigated ethnographic accounts of cannibalism from New Guinea, archaeological evidence of cannibalism from other areas of Polynesia, suggest that the meaty parts, such as thigh, shoulder, and arm, are the more desired parts of this gastronomical predilection (Philip Newman, Robert Rechtman, personal communication. In Polynesia, human meat is distributed for consumption through lineal

relationships (Rechtman, personal communication). This is viewed as strengthening the clan.

In Columbia, cannibalized remains were placed in pits. A pit was dug, filled and covered, and a new pit was dug next to it. Archaeological evidence indicates this to be a common practice since Formative times. One would expect to find then, evidence in the archaeological record such as pits with disarticulated human remains.

The Ft.18 concentration of secondary remains differs from other secondary and fragmentary remains found in the southern and central areas between Op.8A, OP.8C and Op.8E in that the latter are skull burials and are not confined in an area of burned soil (see Burials 7, 9, 10, 21, 22, 41 and Plate 24).

Although archaeologists deal with empirical data, the ritual correlates of the material remains are very important in understanding mortuary behavior. There are economic considerations and symbolic connotations involved in virtually every aspect of burial. Furthermore, disarticulation and secondary burial embodies a human element; mortuary data are, after all, ritual data (Goldstein 1986). Secondary disposal, through disarticulation and burial, implies a lapse of time

between death and burial. This may entail time for the body to decompose, perhaps time enough for the relatives to come to grips with the impure nature of the deceased, or their reconciliation of fear of the dead (Wire 1972). Labor investment includes such disruption of communal activities.

Paleopathology

Although bone preservation was generally good, the calcareous encrustations limited visual pathological assessments.

Arthritis

Evidence of arthritis was observed in a number of individuals as was usually characterized by "lipping", a build-up of osteophytes along the margin of the vertebra centra (Ubelaker 1978:78). Burial 28 exhibits slight lipping around the margin of the head of the right humerus suggestive of osteoarthritis. Burial 31, an old adult male, exhibited vertebral osteophytosis on several lumbar vertebrae (Verano 1982:5). Burial 106 (middle adult, male) exhibits lipping in cervical vertebrae indicative of osteoarthritis. Burial 110 exhibits lots of lipping of thoracic vertebra, and Burial 104 exhibits arthritis of the patella (mechanical).

Burial 110 also exhibits possible pathology of the cranium indicating resorption, or it may be due to normal deterioration. Burial 81 (male?, 45-50) exhibits some resorption of parietals. Burial 104 (M?, @50) exhibits resorption of cranium and obliteration of cranial sutures, a common occurrence in advanced age.

Dental Pathology

Verano noted that a number of adults with observable dentition exhibited dental caries, yet caries were not observed in dental remains of juveniles. The maximum number of caries found in one individual was 5 in Burial 53, an old adult male (Verano 1982:5). Evidence of periodontal disease and abscess was noticeably absent (although Verano notes dental examination of the alveoli was not always possible due to encrustations). Two adults were edentulous (Burials 25, 77) and several others (Burials 71, 102, 104, 105, 110), not all individuals of advanced age, had lost nearly all their teeth during life, which suggests that some form of periodontal disease may have been present in these individuals (Verano 1982). Burial 110 (an old adult male), practically edentulous except the lower 3R, evidences much osteoporosis of maxilla. Burial 102 (a female 20-25 yrs. almost edentulous, exhibits osteoporosis of the jaws, yet few

caries. Burial 105 has no maxilla, the mandible is completely resorbed with all molars lost except the lower left premolar and canine. Burial 104 has no lower teeth. One individual (Burial 108), female 35-40 yrs. exhibits enamel hypoplasia (Plate 32).

Anomalies

One extra cusp on upper RM2 is found among the secondary remains of "I" Feature 18 (Plate 33). One peg tooth (upper RM3) is identified in Burial 84, a male?, 30-40 years (Plate 33).

One middle-old adult, female? (Burial 105) exhibits an extra metopic suture running down to the nose (Plate 33). Burial 103, male, 18 yrs., exhibits possible pathology on the right clavicle, close to his sternal articulation, consisting of penetration or infection in the tendon insertion (Plate 33).

Treponematosi

At least two individuals exhibit swelling and anterior bowing of the tibia shaft. This condition is a diagnostic feature in two types of treponemal infections; congenital syphilis and yaws. Verano first noted its presence in one of the individuals excavated in 1981 (Burial 73). Based on the limited sample, Verano declined

specific pathologic interpretation. Vazquez identified a similar condition in the second individual (Burial 82), from the author's 1988-89 excavations. This pathology is noted in this individual's right and left femora (Plates 34, 35), and both humeri (Plate 36). This type of pathology was noted in the tibiae of an individual found at nearby Playa Jicaro (Hardy 1988). This last example was collected by the author, who caught looters excavating the mortuary remains; Vazquez examined these remains.

Burial 73, a middle adult, female, was associated with ceramics dating to the end of the Zoned Bichrome and Early Polychrome periods, whereas Burial 81, was associated with monochrome ceramics of the Middle Polychrome Period. The skeletal remains from Playa Jicaro were associated with Middle and Late Polychrome Period ceramics, although the association is somewhat uncertain due to the looted nature of the materials.

Pathological evidence for syphilis is demonstrated in precolumbian skeletal remains from Panama and is currently undergoing analysis (Cooke, personal communication). McGimsey III et al (1987:140) indicate evidence for congenital and contact syphilis in the Cerro Mangote skeletal population possibly as old as 5000 years. The presence of syphilis in precolumbian populations has long

been a controversial subject among physical anthropologists. Baker and Armelagos (1988) have recently addressed the pertinent issues of the Old vs New world origin of syphilis. I do not attempt to settle the controversy but report the archaeological data and analyses, and leave the diagnosis to those more qualified than I.

Osteomyelitis

According to Steinbock (1976:60) this is a general term describing infection of the bone by various kinds of microorganisms, and usually refers to an inflammation of the marrow cavity but may also include inflammation of the periosteum (periostitis) and inflammation of bone (osteitis). Pathogens often reach the bone via bloodstream (hematogenous osteomyelitis), or bone may become infected directly through severe trauma such as compound fracture or burn (Steinbock 1976). These primary bone infections may create secondary foci by hematogenous spread to other bones (Steinbock 1976).

Fractures

Burial 80, an adolescent or young adult of undetermined sex, exhibits a fracture on the proximal third of the radius; the fracture is consolidated and exhibits heavy osteoporosis (Plate 32). Among the secondary bone groups

of Feature 18, "B", an adolescent or young adult, exhibits a fracture of the distal third of the radius, fracture is consolidated (Plate 32).

Cranial Deformation and Dental Mutilation

No evidence for cranial deformation or dental mutilation has been found to date in the Nacascolo beach cemetery although evidence for both practices may be found at sites around the bay including Nacascolo (Verano 1982). Dental mutilation is evidenced among secondary skeletal remains excavated by Wallace and Accola (1980) dating to the Middle Polychrome Period; one cranium exhibited single-grooved, filed teeth, described as type A-1 dental mutilation (Romero 1958), a type known for Mesoamerica. Dental mutilation is known from Middle Polychrome Period burials at La Guinea (Hoopes 1980) as evidenced by one individual with type A-1 filing on the maxillary incisors and the mandibular incisors filed to triangular points (type F-1). Stone (1977:86) reports dental mutilation from Middle Polychrome mortuary contexts at El Moral de San Blas. Fleischhacker (1972) recorded Type A-1 (Romero) dental mutilation from southern Nicaragua. Ryder apparently found an incisor with A-1 filing in the backdirt of a looters pit in an Early Polychrome Period cemetery at La Fabrica (cited in Wallace and Accola 1980), but this early association should remain suspect until

additional evidence for dental mutilation during the Early Polychrome Period is available. The La Fabrica Site is part of the Central Valley/Cordillera, and not considered part of Greater Nicoya

Evidence of Type A-1 dental mutilation is most prevalent in southern Mexico, appearing at Teotihuacan and Labna around A.D.500-600; F-1 filing appears at this same time in Guatemala at Kaminaljuyu, and both types are well represented throughout Mesoamerica during Classic and Post-classic times (Romero 1970). With the exception of the A-1 incisor found by Ryder in looters' backdirt, it appears that these practices did not enter the area until the Middle Polychrome period, probably with the arrival of Pipil-Nicarao.

At contact, Oviedo reports only the Nicarao practiced cranial deformation (1976). Cranial deformation is not evidenced in Nacascolo beach cemetery. Verano (1982:6) reports being shown a skull in a private collection allegedly from Nacascolo, whose cranium exhibited tabular erect deformation (Imbelloni and Dembo 1938). To my knowledge this is the only occurrence of this type of cranial deformation in Costa Rica. It should not be considered indicative of Nacascolo cultural practices due to its uncertain provenience and unknown temporal

placement. At Los Angeles, Ometepe Island, at least half of the skulls (without differentiating age or sex classes) are noticeably deformed. For the most part, these show the "tied-board" straight tabular deformation type" identified by Comas for Nicaragua (Fleischhacker 1972). In some cases another (unidentified) technique is apparent, causing forehead flattening, which does not alter the contour of the occipital area (Fleischhacker 1972).

Dating the Cemeteries

An inherent problem in determining culture change is the difficulty involved in dating the archaeological remains; control over chronology illuminates questions of culture change over time or may indicate that a variety of customs was practiced at the same time. When remains are directly associated with something which can be 14C dated, the accuracy of the date is usually more reliable than relative dates obtained from comparative ceramic analysis of associated ceramics within a given burial or ceramic lot. The Nacascolo data shed light on contemporary ceramics and enable identification of Precolumbian trends such as heirlooming, or obtaining previously owned ceramics through intrusive activities (Precolumbian grave disturbance).

I speak specifically of instances in which apparently early ceramics are associated with later period ceramics. For example, Lange (1976:48) identifies a Guinea Incised vessel associated with a Cervantes and a Mora vessel. Guinea Incised is found toward the end of the Zoned Bichrome Period, and the latter two are considered Early and Middle Polychrome periods respectively. This ceramic lot was obtained from a bell-shaped burial pit. I am uncertain as to whether these materials were sherds used as burial fill or broken vessels placed with the actual burial. Their association prompted Lange to question Baudez's temporal placement of Guinea Incised, a type he securely dates to the Early Polychrome Period, and which Lange et al (1984) subsequently placed at the end of the Zoned Bichrome Period (300-500 A.D.).

I believe what we are seeing is evidence of a Precolumbian tendency to rebury grave offerings, encountered during excavation of new graves, with the newly deceased individual; or, perhaps this is evidence of heirlooms passed down from generation to generation. Baudez (1960) indicates possible tomb reuse at Bolson, suggesting similar practices. This type of disturbance-reburial-reassociation of grave offerings is not uncommon. Brown's (1990) reassessment of Moundville material

indicates reuse of burial grounds so that later burials were often interred with the grave offerings originally placed with an earlier individual but disturbed during the later interment, then reburied and hence associated with the later individual. This he believes would explain the apparent disparity between social complexity suggested by the quantity of rich and exotic grave offerings associated with some of the burials, and the lack of subsistence and settlement data necessary to support it; in other words, they were reusing grave offerings as well as grave sites.

One must therefore be very careful in assessing contemporaneity and social complexity derived from such analyses. This emphasizes the importance of radiocarbon dates obtained from Nacascolo beach cemetery (Figure 4.10).

According to the radiocarbon dates, beach cemetery use spans over 2000 years; this is not an impossible situation but certainly one which requires discussion. Of the six radiocarbon dated samples, four were derived from carbonized wood found in association with burials and two were derived from human bone (Burials 31 and 36). The human bones were dated and discussed as part of my M.A. research (Hardy 1983). My initial concern in dating the two burials was to show that flexed burial position was

RADIOCARBON DATES FOR NACASCOLO BEACH CEMETERY

Sample Material	Provenience Associations	Raw Date	Caliberated Date
UCR-1547 wood	Burials 51 and 52 115 cm.	2525 +-120	810-410 B.C.**
UCLA-2396B human bone	Burial 36 162 cm.	1845 +-235	140 B.C.-420 A.D.*
UCR-1543 wood	Cache 1 Infant area 117 cm.	1730 +-90	A.D. 150-420*
UCLA-2396A human bone	Burial 31 188 cm.	1310 +-210	A.D. 550-960*
UCR-1544	Cache 2 102 cm.	910 +-80	A.D. 1024-1226*
UCR-1546 wood	Burial 61 151 cm.	600 +-80	A.D. 1283-1414*
UCR-1545 wood	8G 140 cm.	220 +-80	A.D. 1635-1686* A.D. 1736-1808* A.D. 1930-1955*

* Calibrated according to Stuiver and Pearson 1986.

** Calibrated according to Pearson and Stuiver 1986

Figure 4.10 Radiocarbon dates obtained from Nacasclo beach cemetery Op.8A-M.

older than the extended position. Great care was exercised in choosing the samples; burials were in good condition and both were associated with identifiable ceramics which would help in cross-dating the burials. Burial 31, a flexed, adult male, and Burial 36, an extended female, were chosen. Ceramics associated with the flexed individual included Tola Trichrome (Norweb 1962) and Yayal Brown (Baudez 1967), ceramics typical of Zoned Bichrome and Early Polychrome Period, whereas the extended individual was associated with a Papagayo (Baudez 1967:142-43) vessel, a diagnostic Middle Polychrome Period ceramic. My conclusion, based on the absolute dates obtained, and the contradictory evidence of the associated ceramics, was explained as contaminated samples or erroneous chronology. Since then, I have received results of five more radiocarbon samples collected by Dillon (UCR 1543-1547, personal communication). While they are wideranging dates, I do not believe them extraordinary. On the contrary, considered as a group, these dates are valuable for chronologic assessment and interpretation.

The temptation to view suspicious or contradictory dates as by-products of contamination, or faulting the radiocarbon dating method, is greater than accepting the responsibility for excavator and/or post excavation handling error. While the radiocarbon dating method does

have limitations, many of the problems encountered with carbon sampling can only be addressed by the archaeologist. These middle-range theories concern processes which have influenced the samples deposition; how it came to be deposited where it was found, how and who might have contaminated the sample, and the material being dated, are but a few of the necessary considerations.

The Nacascolo sand spit in general, and the beach cemetery specifically, have experienced and continue to undergo a tremendous amount of potentially destructive activities; wind-blown sand, land crabs, rodents, iguanas and other burrowing animals, tree roots, the interaction of calcium rich shell and salt water, and possible organic contaminants emanating from the mangrove swamp, seemingly all conspire to influence the dated sample and confuse the archaeologist. Precolumbian mortuary practices themselves, and subsequent grave looting in historic times likewise affect the archaeological record, But the extent of these cultural activities are, in general, more easily recognized than the biological ones.

How then does one reconcile the 2000 year difference and conflicting radiocarbon dates? The earliest carbon date 810-410 B.C. (UCR-1547), was obtained from a wood fragment associated with Burials 51 and 52. Both of these

burials are infants, found within an area noted for the number of infant remains and artifacts traditionally associated with high status individuals (e.g. metate and jade). Directly associated with Burials 51 and 52 were four ceramic vessels, types Charco Black on Red (Baudez 1967), Los Hermanos Beige or Monte Cristo Beige (Baudez 1967), and an almost purple, shallow incensario with pedestal base and incised cross on the base (Plate). All of these are found during the Zoned Bichrome Period Orso Phase (300 B.C.- A.D. 300) although, I find it unusual that Charco is not reported during the earlier Loma B. Phase (600 - 300 B.C.). Perhaps this date will find acceptance for an earlier appearance of Charco, at least at Nacascolo. If this date is indeed valid, its significance would underscore the importance of the Nacascolo beach cemetery as the repository of one of the oldest skeletal populations found in Costa Rica, as well as demonstrating early dates for site occupation comparable to Vidor. This date is also compatible with the one obtained from Isla Venado in funerary contexts (450 b.c., Guerrero, personal communication).

Sixty-five cm. to the east and two cm. deeper, a radiocarbon date of A.D. 150-420. (UCR-1543) was derived from a piece of wood found in association with several infants and grave offerings including a plain tripod

metate and ellipsoidal mano and (Arts. 170 and 171: Plate), one tubular jade bead (Art. 167; Plate), and ceramics including Yayal Brown (Art. 172) and a negative resist, red ware (Art. 173: Plate), and a worked Strombus granulatus shell (Art. 190). The date corresponds well with general consensus regarding the ceramic types, mano and metate, and jade. While the artifact concentration is clearly within the realm of artifact types found at this time, the associations are less clear. As was explained in the discussion of cemetery spatial organization, the number of infants associated with this artifact concentration is uncertain due to their disappearance during heavy rains; nor am I able to ignore the possibility of an undiscovered adult burial below the infants.

The two dates derived from human bone UCLA-2396B (140 B.C.- A.D. 420) and UCLA-2396A (A.D. 550-960), are confusing. While I gladly accept the chronology indicated by the two dates, I cannot accept the early date for Burial 36 and the associated Papagayo ceramic. The date obtained for Burial 31, might well be valid if the early range is accepted. I do however, feel this burial dates closer to the end of the Zoned Bichrome Period. It is too coincidental and too contradictory to accept these dates as anything but indicative of human error expressed in

mislabeled, switching, or interpreting the samples, or recording the dates.

How might this be resolved? Suffice it to say that the dates are correct for the general occupation of the cemetery, but it is questionable to associate them with specific burials even though the bones themselves were dated.

UCR-1544 (A.D. 1024-1226) was derived from wood and found in association with several undecorated monochrome wares (Cache 3). This date is well within the timespan of the cemetery. No burial was encountered within 130 cm. depth, but this does not preclude the possibility of one at greater depth.

UCR-1546 (A.D. 1283-1414) was also derived from wood found in association with Burial 69, an adult male, in extended position on stomach. No grave offerings were found with this individual. The date indicates cemetery use into the Ruiz Phase of the Late Polychrome period.

The last and latest date (UCR-1545), has three possible calibration dates, and all are problematic. It is highly unlikely that this burial could have taken place at the time indicated, for no evidence has been found

supporting Nacascalco site occupation into historic times. The sample was encountered at 140 cm. depth and within 20 cm. of Burial 54. I can only explain this as coincidental intrusive action.

Additional Cultural Features and Mortuary Behavior

In addition to burials, the cemetery is a repository for expressions of religious beliefs and cultural behaviors of the precolumbian inhabitants of Nacascalco. There are seven types of features: 1) Concentrations of sherds, shell, and rocks; these are near the surface, are relatively shallow deposits, yet may have wide vertical dispersal (Features 1b, 2b, 4, 5, 6, 11). I suggest they are not mortuary offerings but relate to the activities conducted on the sand spit during Middle and Late Polychrome Periods which may or may not have anything to do with mortuary behavior; 2) Concentrations of shell, few sherds and rocks; these are distinguished from the former concentrations in that they are found below the surface (approximately 40cm.) and are associated with burials. Sherd concentrations overlying burials is considered indicative of Mesoamerican influence (Stone 1958). Here they are found in association with one flexed (Burial 85:Plate 37) and an extended burials (Burials 54, 79); the flexed individual, according to the associated

mixed Charco-Cabuyal ceramic type, dates roughly to the end of the Early Polychrome Period, whereas the extended burials (54 and 79) date to the Middle Polychrome Period.

- 3) Ovens, of adobe and sherds (Features 7, 13 and 12/17.
- 4) Small cache offerings of artifacts, shell, and/or faunal remains (Features 8, 9, 10: these are discussed with "Animal Ceremonialism").
- 5) Stone tomb cap/hearth (Feature 1) with caches of offertory objects comprising the tomb fill of Burial 34.
- 6) Feature 18, a concentration of dark and reddish burned soils, associated with thirteen groups of secondary remains.
- 7) Feature 19, a non-random concentration of Ostrea shells, possibly a floor.

Some of the cultural features are straightforward concentrations of shell, rock, and sherds overlying burials or caches; while others, such as Features 1, 13, 18, and 19 are somewhat enigmatic and warrant full description and discussion.

Feature 1 (Plate 38) Concentration of rocks and burned soil in 8A-E. The top of this feature was encountered at 102 c.m.. It is roughly circular in shape, approximately 2 meters in diameter, with a maximum thickness of 50cm. This was a major feature during the 1980 field season and was considered a central focus of cemetery activity; one

could argue against this "center" concept in light of the unknown nature of the cemetery's size and shape. Based on the amount of carbon found among and below the rocks, this feature was originally referred to as a hearth. A pit was clearly delineated in the southeast part of the feature, the dark soil continuing south and bisecting Burial 14. Two artifact caches were found below the rocks: 1) consisting of a plain tripod metate, ellipsoidal mano, and ceramic vessels (Arts.39-45), was found slightly to the northwest of an hypothesized feature center (Plate 38), several bone fragments were associated near this cluster (Burial 15); and 2) consisting of ceramic vessels 88, 89, and 90, located in the southern part of the feature. A pit was noted below the southern portion of the feature which bisected Burial 14. After the UCLA crew left the site at the end of the 1980 field season, additional burials were excavated by MNCR archaeologists one of which (34) appeared to rest below part of this feature (Plate 39). After careful analysis of burial and feature maps, it became clear that Burial 34 rested below the northern half of this feature, yet no burial was found in the southern portion. While it would not be outside the realm of possibilities that the two artifact caches were associated with the "hearth" there was no explanation for the pit found below which also cut Burial 14. I suggest that Feature 1 is actually two burial tombs; one (the

northern portion of the feature) containing Burial 34, the other tomb (southern portion) containing the artifact cache (Arts.88,89,90) in the western end of the southern portion. Curiously, no skeletal remains were found in the southern portion. The feature appeared essentially intact but it is now clear that postdepositional disturbance has occurred. What could explain this pattern? According to Rechtman's notes, workmen laying a PVC pipe during construction of the Von Bailey house, encountered rocks, ceramics and a skeleton in this area. It is likely these workers disturbed this tomb. An hypothesized scenario has them entering the tomb not from above through the rocks, but from their work pit to the east. This would explain the cutting of Burial 14 as well as why no burial was found below the rocks. The two artifact caches would therefore be part of the burial fill associated with these burials, the burial pits filled with rocks, and burning taking place. If this is the case, based on associated ceramics, the southern part would most likely be older than the northern part, the feature appearing as a single unit due to some rock borrowing and overlap. Burial 34 would therefore be the "richest" individual thus far encountered in the cemetery, associated with 3 metates, 1 mano, 1 celt fragment, 1 sandstone polisher and 14 ceramic vessels. Grave offerings provided the other individual were most likely removed during PVC disturbance, with the

exception of the three vessels Arts.88, 89, and 90.

Why did the looting stop? Three reasons are suggested: 1) time limitations, 2) the possibility that the workers were supervised and therefore were not at liberty to loot, and 3) a tendency to look for valuable objects of gold, jade, and fine ceramics, when these were not found they quit looting. The third suggestion appears more likely. It would also explain why they evidently did not return. Had anything of great value been discovered, the looters would not have stopped and word of the riches would have spread quickly throughout the bay area, Sardinal and Liberia. Subsequent huaquero activity would have completely destroyed the beach cemetery. Since undisturbed remains comprise the bulk of the cemetery, the suggestion that huaquero activities were of limited nature is supported.

Feature 13 Six ovens composed of adobe and sherds found near the surface of Op.8K (Plate 40). They are oval-shaped and range in size from 134cm. X 56cm. (oven 2) to 80cm. X 24cm. (oven 3). They are similar in form to one found at a greater depth in 8H (Feature 1 from 1982 excavations: Plate 41). In cross-section the ovens are u-shaped and they probably had roofs which have since collapsed. A large quantity of crude, heavy, monochrome

sherds were associated with the ovens. A complete garrobo (iguana) skeleton (Ctenosaura similis) was uncovered within 20 cm. of oven #1, but no other faunal remains were recovered (the iguana burial will be discussed in "Animal Ceremonialism"). Whether this indicates a functional aspect of the ovens or is due to preservation is uncertain at this time. This type of oven is also found at La Ceiba, in mortuary contexts dating to the Middle Polychrome Period (Guerrero and Blanco 1987). Interestingly, at La Ceiba, an almost identical number of burials and ovens were found suggesting an association between the ovens and the graves, perhaps a type of "last supper" or meal was prepared for interment with the deceased, or for a funerary feast. Floral evidence analyzed from vessels and ovens of La Ceiba indicate an array of agricultural products including corn (Zea mays), beans (Phaseolus vulgaris), palm (Oribignya), avocado (Persea americana), and zapote (Pouteria sp.) (Guerrero and Blanco 1987).

It is uncertain that the Op.8K ovens functioned as part of mortuary or economic behavior. Burning plays an important role in mortuary practices throughout Nacascolo and for that matter, throughout Mexico, Central and South America, and is often evidenced by ovens. In virtually every excavation at Nacascolo some form of oven

has been encountered; Plate 42 demonstrates the variety of ovens encountered in excavations throughout the site. While not all of these ovens are associated with mortuary contexts, nearly all areas of Nacascolo with mortuary remains have evidence of ovens.

At Chupicuaro, west Mexico, fires were built in hearths called tlecuiles; these are rectangular, square, and basin-shaped depressions in the earth which were lined with packed clay (Porter 1956:527). Many of the 390 human and 46 dog burials were associated with tlecuiles, the interments often circling them (Porter 1956:527, 528). These ovens always contained ash and cinders.

One remarkable aspect of the Op. 8K ovens is the complete lack of carbon, a significant factor in comparison to the ovens found at La Ceiba. I believe that this is due to the surface location of the beach cemetery's ovens. With no attempt to cover them, exposed to rain and wind blown sand, the carbon (as well as faunal and floral remains?) was not preserved.

Based on the quantity of crude ceramics found, and the lack of faunal remains, it is unlikely the ovens were used for food preparation although the possibility of plant food preparation at some type of commemorative

ceremony should not be summarily dismissed. An alternate interpretation for the ovens of salt-production might be more plausible. Salt water would have been placed in heavy vessels, boiled in the ovens, and then the vessels broken to extract the salt. This would certainly explain the quantity of crude-type ceramics associated with the ovens.

A small trench (1.5 X 2m.) was excavated between the ovens to see what lie below. Rocks were encountered, clearly delineating burials, and burials 108, 110, 111 and a canid burial were found. Burial 108 (Plate 43), a middle adult, female was placed flexed on her right side, a jade/greenstone pendant below her mandible. She and Burial 110, a middle adult male, placed on his back in a tightly flexed position and associated with one ceramic vessel and a Lyropecten subnudosis, date to late Zoned Bichrome-Early Polychrome Periods. Burial 111, an adult male, placed in extended position on stomach, was associated with a stone celt in his right hand; he dates to Middle Polychrome Period. The canid lie approximately 40 cm. to the east of Burial 108 but it is not clear if they were, in fact, interred at the same time. I think the canid is intrusive.

Feature 19

Shell floor. This feature consists of a single layer of Ostrea shell in the floor of the westernmost part of the cemetery of 8J, and enters the west and north sidewalls (Plate 44). It is not a natural formation, nor dense concentration, but each shell placed deliberately so as to resemble a floor. It is possible it served as barrier between the deceased and the water table. Burial 105 rests on top and at the southernmost extension of the shell floor but the shell extends over two meters north and enters the north and west sidewalls. It cannot be said then, that the shell floor was placed solely for Burial 105, for the feature extends beyond its burial area. Exactly when it was placed is unknown at this time, though it must have been constructed before the interments of Burials 80, 91 and 101 for the floor exists over 50cm. below them, their interments not disturbing the integrity of the feature.

What function then does this feature serve? I find no archaeological or ethnographic parallels for similar shell floors but several types of floors have been reported in mortuary contexts within the region. While attempting to reconstruct a burial pit disturbed by looters at Nosara, Lange (1977:33) noted a prepared white clayey floor upon which were placed the remains of at

least 13 individuals. He estimates the burials date to the Middle Polychrome Period. Hoopes (1980:54) noted similarities between a compact sand floor found at La Guinea and that of Lange. While the above concentrations (shell or compact earth) are not the same, they do appear to be variations of the same idea and suggest similar functions (whatever they may be); perhaps it's a precolumbian attempt to keep the earth from the deceased.

A curious comment may be made on the quantity of monochrome sherds comprising various features in the Nacasclo beach cemetery. Among the thousands of pot sherds, less than fifty are polychromes. Based on sheer numbers and absence of polychromes, utilitarian wares are sufficient for many mortuary ceremonies. Tipo cien (Lange), other crude wares, nondiagnostic brown, red, and beige wares are the most representative. Apparently, in this cemetery, the mourners weren't sacrificing their best wares in burial fill or ritual expressions of the belief system. Polychromes were placed as grave offerings directly associated with the deceased, but they were not discarded in burial fill. It's as if they wanted to make an offering but didn't want to spend too much. This suggests an importance to polychrome pottery; perhaps this is an acknowledgement of the energy required to make the polychromes, and recognition that such costs are not to be

discarded indiscriminately.

Jim Brady (personal communication) relates a similar practice in his Maya cave study at Naj Tunich where the central caches were far more elaborate than the offerings placed off to the side or in rather inaccessible areas.

Animal Ceremonialism

Animal ceremonialism plays an important role in mortuary practices. Three types of animal ceremonialism are apparent: 1) consists of individual primary burials, the animal ceremonially killed and interred (NHB 8H, MHC 7, MHC 8; MHC (2); Plate 45); 2) disarticulated remains of animals which may have been ceremonially killed, possibly eaten, and interred as part of funerary ritual (NHB FT.10, MHC 1, MHC 2, MHC 3, IB II, MCH (3), MCH 6, NHB); and 3) shell cache offerings including Strombus and Ostrea (described previously as Type 3 features 8, 9 and HA2; Plate 46), or shell as tomb fill or grave covering (described previously as Type 2 features 14 and 15 (Plate 37)). Figure 4.11 lists the types of animals accorded ritual treatment in the beach cemetery. Animal Ceremonialism expressed as burials include canids (Canis sp.), and a currasow (Crax rubra). A garrobo (Ctenosaura similis) was found in association with the ovens of

ANIMAL CEREMONIALISM AT NACASCOLO			
<u>BEACH CEMETERY</u>			
Op. Id.	Taxa	Eng./Span.	F/C Associations
8C MCH 1	Cheloniidae	Turtle/Tortuga	F
8C MCH 2	Cheloniidae	Turtle/Tortuga	F
8E MCH 3	Cheloniidae	Turtle/Tortuga	F
8J IB II	Cheloniidae	Turtle/Tortuga	F
8J MCH(3)	Cheloniidae	Turtle/Tortuga	F
8H NHB	<u>Canis</u> sp.	Dog/Perro**	C
8J MCH 6	<u>Canis</u> sp.	Dog/Perro**	F Burial 104
8K MCH 7	<u>Canis</u> sp.	Dog/Perro**	C
8J MCH 8	<u>Crax rubra</u> and other unidentified bird bone	Currasow	C 2/3complete missing head Burial 96
8K MCH(2)	<u>Ctenosaura similis</u> *	Iguana/Garrobo	C ovens (Ft.13)
8A/E	<u>Odocoileus virginianus</u>	Deer/Venado	F Burial 3
8G Ft. 8	<u>Strombus granulatus</u> Pit of 125, some burned		C Feature 8
8G Ft. 9	<u>Strombus granulatus</u> Pit of 125, some burned		C Feature 9
8G NHB 2	Fish (unidentified)		C Feature 10
8G HA 2	3 <u>Strombus flange</u> Testudinata		C Shell and F Bones
<u>OTHER AREAS OF NACASCOLO</u>			
26b RC 7	<u>Nasua narica</u>	Coati	C U-shaped oven
29	<u>Canis</u> sp.	Dog/Perro**	C
<p>C = Complete F = Fragmentary MCH = Muestra Concha Hueso/shell or bone sample MCH(3) = shell or bone sample excavated in 1989 NHB = Non-Human Bone IB = Isolated Bone HA = Hueso Aislado RC = Rasgo Cultural/Feature * May not be deliberate interment ** May be dog/coyote mix</p>			
<p>Figure 4.11 Of 18 examples of animal ceremonialism found outside domestic contexts at Nacascolo, 9 are complete and 9 are fragmentary remains.</p>			

Feature 13. A canid (Canis sp.) cranium and mandible, and a second mandible, were encountered as part of the burial fill of Burial 103. Turtle (Chelonidae), and deer (Odocoileus virginianus) fragments are found in association with burials. One ritual offering includes a fish skeleton and two hammerstones (Feature 10); the fish remains unfortunately, have been lost and identification is unknown. Of the fifteen examples of animal ceremonialism throughout the beach cemetery, five were articulated skeletons, two offerings of whole Strombus granulatus, some burnt, and nine groups of fragmentary faunal remains. The canids, turtles, deer parts and fish, are indisputable evidence of deliberate animal ritual treatment, however, the garrobo burial should not necessarily be considered ritual treatment, since it could have crawled into a hole, on its own, and suffocated.

Evidence of fish use in the Nacasclo beach cemetery include one shark vertebra (cf. Careharhinidae) found on the neck of Burial 44, and one unknown type found with Feature 10. The Feature 10 "fish skeleton," unfortunately, was lost in transit and therefore remains unidentified. These most likely convey religious-subsistence beliefs.

At this time, the identification of the canids must

be limited to Canis sp. The skeletal remains are not identical to either dog or coyote comparative samples; this suggests dogs and coyotes may have been interbreeding (Maritza Gutierrez, personal communication). Another canid burial and a coati (Nasua narica) burial have been reported from other areas of Nacascolo.

Cultural Significance of Animal Ceremonialism and Archaeological Comparisons

The archaeological data supporting indigenous animal ceremonialism, as evidenced by faunal remains and iconographic portrayals, within artifact assemblages are plentiful. Dogs (Canis familiaris) for example, have been found in association with humans for over 9000 years in the New World. Bone artifacts provide evidence for animal use in making tools; midden analysis provides data for animal use in subsistence activities. While it is apparent the precolumbians used many animals for tools, diet, it is less understood, what part animals played in religious and ceremonial activities. Judging by the quantity of archaeological remains and ethnographic data, animals were of tremendous social, religious, and symbolic importance. The animals role among precolumbian cultures simultaneously involvs all these aspects. Religious beliefs are difficult to derive from archaeological

remains but archaeologists gain information in this area by inference to ethnographic analogy; ethnographic sources are useful in understanding precolumbian beliefs underlying various faunal remains found at Nacascolo. Due to an abundance of animal ceremonialism expressed in the archaeological record throughout the Americas, the following discussion reflects only the taxa recovered from the Nacascolo beach cemetery. Iconography depicted in ceramic and stone artifact assemblages likewise convey precolumbian beliefs towards certain animals. Iconographic elements have been identified in Nacascolo assemblages. This is discussed in Chapter 6.

Dogs as Mortuary Offerings

The role of many animals in precolumbian cultures, particularly the dog (Canis familiaris), simultaneously involve religion, diet, hunting activities and companionship. For the purpose of this discussion, the canids encountered in Nacascolo mortuary remains are assumed to be expressions of beliefs regarding dog-like animals, and not differentiated as to taxa. Among the Maya, the dog was connected with death and destruction and regarded as a messenger to prepare the way to the other world (Tozzer and Allen 1910; Wright 1970; Pohl 19776; Schellas 1904; Allen 1920; and Tozzer 1941; in Hamblin

1984:117). In Mexican theology, Quetzalcoatl took the form of a dog to visit the land of the dead (Thompson 1970:300-301). Stone (1967:4) has suggested that the dog "es simbolo de la penitencion."

The belief that dogs aid one to cross a body of water was widespread from the valley of Mexico to central Honduras, is recorded for many groups in South America, and, in general, is characteristic of many cultures in both the Old and New world. It survives among the Chamula Tzotzil, Tzeltzil and the Lacandon (Thompson 1970:300). The Lacandon place a small palm figure to represent a dog at each corner of the burial mound, and these guard the soul on its last journey (Thompson 1970:300-301).

The ritual importance of dogs is evident in the Yucatan where they were sometimes sacrificed in place of human beings (Seler 1890). Maya codices show dogs in a variety of attitudes almost always in context with birds and other mammals considered to be sacrificed (Tozzer and Allen 1910). Pohl (1976:219) refers to Classic Period graffiti at Tikal depicting what she believes is a dog in a ceremonial procession possibly representing the prelude to the animal's sacrifice. Landa described the sacrifice of a dog "spotted the color of cacao." The heart of the animal was often removed and burned; the blood used to

anoint the idols, and the animal was then cooked and eaten (Tozzer 1941:109 in Hamblin 1984:119-120).

In precolumbian Mexico, dogs were raised and greatly esteemed for food (Simoons 1967 in Wing and Brown 1979:11). Historians indicate Indians considered dog meat a delicacy, and that hairless dogs were found in 16th century Mexican marketplaces (Wright 1970 in Hamblin 1984:120). According to Oviedo, the Nicarao and Chorotega raised two types of dogs: the "noisy barking" and "mute" dogs were revered, used in their ceremonies, and also eaten (Melendez Ch.:1978:52). Oviedo (1976) described how a cacique or important person was given the dog head to eat. He would eat what he wanted, and give the rest to a person of his choice. Interestingly, whereas these sources suggest the eating and ritual use of canids a common occurrence, not one canid bone has been found among the 8000 bones identified in Nacascolo faunal remains (Gutierrez, personal communication). This apparent food-avoidance for canids, implies that the ritual treatment attributed canids, had to do with religious beliefs concerning this animal, and are expressions of dogs as companions, good hunters, and guardians of the homesteads, and not canids as food. Sauer referred to such food-avoidance as the 'Rover complex' (Simoons 1961 in Cooke 1989:7).

The dog, both actual and effigy, as mortuary offering is a widespread and ancient tradition, found throughout Mexico, Mesoamerica, the Intermediate Area, and South America. In Maya tombs, dog skeletons are well documented. At Kaminaljuyu, a dog skeleton was found in the tomb of a high status male (J.E.S. Thompson 1966:218). A multiple burial at Tikal contained dog bones in it (Hamblin 1984:118). At Zaculeu, three dog skeletons (two immature) were intentionally interred in two human graves, and two fragmentary dog skulls were found in a cache and another burial (Woodbury and Trik 1953). Dog bones occur in at least two different tombs (Lots C-30 and A-125) at Mayapan. In addition, large quantities of this animal were found in debris from a floor and from building debris between a colonnaded hall and a temple platform at the same site (Pollack and Ray 1957 in Hamblin:118). Hamblin reports 69.9% of dog remains, from Cozumel, are from burial or ceremonial contexts; only 4.3% come from household contexts. Forty percent of the dog bones associated with human burials at Cozumel were from young puppies (Hamblin 1984:114).

Dogs interred with human burials are found in western Mesoamerica at the Morett Site in west Mexico (Meighan 1972:22). At Chupicuaro at El Rayo, Porter reports a

large number (49) of intentionally interred dogs in a human cemetery. Some of the dogs were provided grave offerings of obsidian (Porter 1956). One adult dog skull was possibly a trophy skull (Porter 1956).

Dogs are common at this time in Mexico and are not, according to Porter, the same breed as later found on fat pottery dogs from Colima which seem to represent dogs used for food. Stone 1967:5).has written that the dog effigy represents "la raza Xolitzuntl que se ve a menudo en la ceramica de Colima

Dogs were also used to hunt deer (Hamblin 1984:104). A Classic period polychrome ceramic vessel shows the use of dogs in a hunt; Spaniards observed the Yucatecan Indians hairless dog in the hunt of deer and birds (Tozzer 1941:186,203). Pohl (1976:218) reports that many scenes on ancient pottery depict dogs on trading expeditions and she suggests "the animals may have served as guards against thieves and highwaymen which were a menace in Postclassic times" (Hamblin 1984::120). Thompson (1970:301) reports a flint carving of an alert dog from a Maya tomb.

Evidence indicates that dogs were also of medicinal value. According to Wright (1970:36-37), the "hairless

dog" may have been used as a water-bottle to alleviate ailments and pains. In some areas, possession of such a dog is still believed to protect people against colds and other illnesses (Hamblin 1984:121).

Dog teeth may have held special meaning for the Maya. Perforated canines, carnassials, lower molars and roots, have been found at Mayapan, Seibel, and Altar de Sacrificios (Pollack and Ray 1957; Olsen 1972, 1978 all from Hamblin 1984:114). The drilled holes appear as if for stringing, or personal adornment. .

Other Animals Used in Ritual

In addition to dogs, other animals were raised for food and/or sacrifice. Landa mentions that Maya women raised fowl such as white mallard ducks, turkeys, and doves, for food and for sale (Tozzer 1941:127,201 in Hamblin 1984:94). Schorger (1968:13) cites various references to the capturing and raising of curassows and chachalacas. Curassows and doves are found in Cozumel sites in ceremonial and household contexts (Hamblin 184:94). Landa refers to the sacrificial offering of birds, their blood, hearts, and feathers (Tozzer 1941:23, 109, 124, 163, 165, cited in Hamblin 1984:95). Some animals, offered as ritual sacrifices in Maya religion,

Feature 13. A canid (Canis sp.) cranium and mandible, and a second mandible, were encountered as part of the burial fill of Burial 103. Turtle (Cheloniidae), and deer (Odocoileus virginianus) fragments are found in association with burials. One ritual offering includes a fish skeleton and two hammerstones (Feature 10); the fish remains unfortunately, have been lost and identification is unknown. Of the fifteen examples of animal ceremonialism throughout the beach cemetery, five were articulated skeletons, two offerings of whole Strombus granulatus, some burnt, and nine groups of fragmentary faunal remains. The canids, turtles, deer parts and fish, are indisputable evidence of deliberate animal ritual treatment, however, the garrobo burial should not necessarily be considered ritual treatment, since it could have crawled into a hole, on its own, and suffocated.

Evidence of fish use in the Nacasclo beach cemetery include one shark vertebra (cf. Careharhinidae) found on the neck of Burial 44, and one unknown type found with Feature 10. The Feature 10 "fish skeleton," unfortunately, was lost in transit and therefore remains unidentified. These most likely convey religious-subsistence beliefs.

At this time, the identification of the canids must

1984:59-66). Iguanids likewise had considerable importance in Maya religion (Hamblin 1984:72). At Cozumel and Mayapan, iguanids are found in ceremonial and administrative contexts, rather than households (Hamblin 1984:70). Iguanids appear in the Maya codices almost exclusively as ceremonial offerings (Tozzer and Allen 1910:318 as in Hamblin:1984:72). According to Landa, iguanids were used extensively as sacrifices, and as an alternative foodsource when religious rules otherwise forbade meat consumption, and also used in medicine (Tozzer 1941:122, 148, 154, 164, 191 as cited in Hamblin 1984:72). Iguanas represent a convenient source of meat in the tropics (Minton and Minton 1973 cited in Hamblin 1984:69), and iguana eggs are exceptionally rich in calcium and vitamin A (Pohl:1976:235 cited in Hamblin 1984:69).

Despite the ritual and dietary significance of iguanids among the Maya, the iguanas typical lifestyle and burrowing nature may explain the creatures presence in the Nacascolo beach cemetery.

Deer also play a role in Maya religion. Deer bones were supposedly used in shaman divining rituals. At Holmul, Guatemala, a collection of nineteen deer bone, some worked, were found in a burial (Merwin and Vaillant

1932 as in Hamblin 1984:142). There is also evidence for a possible deer sacrifice found in a burial at San Gervasio (C-22, gr.7, pit212, burial 37; Hamblin 1984:142). Deer metapodials were often used to make awls and needles; these were sometimes burned to harden them (Hamblin 1984:142).

Evidence suggests Procoynids were raised as pets and later sacrificed and/or eaten as food. According to Landa, the women of Cozumel raised pisotes or coatis for such purposes (Tozzer 1949:204-205 in Hamblin 1984:146). Pohl (1976:150) identifies animal figures held by women on Late Classic pottery as pisotes or coatis. These vessels were found at Altar de Sacrificios and Lubaantun. She asserts that the traditional use of this animal as a fertility symbol may explain its association with women. Among modern Lancandon Maya, ethnographic evidence indicates that coatis are a food reserved for women (Pohl 1976:1500). Hamblin (1984:146) reports that the use of procoynids, on Cozumel Island, as widespread, yet curiously, this quantity appears to be unique to Cozumel, is not duplicated at other Maya sites, and there are no procoynids in the Maya codices. This suggests to Hamblin, that these animals had no special ceremonial or sacrificial value. There appears to be only individual bones and no whole animals, suggesting use as food not

ritual. Hamblin concludes that it would seem that some animal use on Cozumel was more a matter of island adaptation and secure food sources than religious expression.

Shark remains also form a small part of Maya animal ceremonialism. Teeth and vertebrae, sometimes with a hole drilled in the center, are found and may have been used as pendants. These have been reported at Cozumel and Zaculeu in ceremonial and household contexts of Late Postclassic (Hamblin 1984:24-31), and Pohl and Healy (1980:290) report a large drilled fish vertebra (possibly shark).

Thompson (1944) discusses the appearance of fish in Maya glyphs (in the Dresden Codex, sculpture, ceramics, and elsewhere) and concludes that the animal was used as a symbol for counting. Linguistic evidence lends support to this hypothesis (Hamblin 1984:45). The Maya word for counting is Xoc (or Xooc), but in Yucatec, the word also appears to stand for an ill-defined group of large fish (especially sharks) or whales (Roys 1933). Thompson notes some of the serrated teeth and elongated snouts which are characteristic of sharks. The variable fish glyphs lead him to believe that Xoc isn't a particular species or group of fish but rather a "large mythological monster with no immutable characteristics, and with a tendency to

become anthropomorphized" (Thompson 1944:17).

Continuity of the ancient practice of animal ceremonialism among the Maya is evidenced through their ritual treatment into historic times, as well as demonstrating Spanish influence and adaptation. Horse bones have been found at three different sites on Cozumel in association with burials (Hamblin 1984:143).

Archaeological Comparisons of Animal Ceremonialism

Archaeological examples of animal ceremonialism, differentiated here from dietary remains, are plentiful throughout Mesoamerica, but are reported less often in mortuary contexts of the immediate study area. This is most likely due to poor preservation, although the lack of data may reflect a preoccupation with faunal remains as dietary indicators. Baudez mentions "fish bone found inside a vessel from E-1" at Papagayo, and "fish vertebrae" found inside a vessel from "Tomb W-8, the west cemetery at Papagayo," in contexts dating to the Early Polychrome and the beginning of the Middle Polychrome Periods respectively (Baudez, Papagayo notes). Ritual treatment of animal remains reported from the Vidor cemetery include a "small bird skeleton" listed by Kerbis

on a feature record (#32) from Vidor, a pierced tapir (Tapirus baird) tooth "of possible ritual or commercial value" (Kerbis 1980:126), and a "distal tibiotarsus of Sarcoramphus (king vulture)" (Kerbis 1978 as cited in Healy 1980:290). Pohl and Healy (1980:290) suggest that this bird, and a tibiotarsus of Sarcoramphus found in excavations at Rivas, may have been procured for ceremonial purposes. Kerbis does not distinguish between faunal remains from domestic and ceremonial contexts (at least such information is not clear) in his article, and from the onset he states "for purposes of environmental discussions, only locally procured and eaten terrestrial fauna are included." He excludes "domestic species (dog, turkey), marine turtles, bats and non-terrestrial foraging birds" (Kerbis 1980:126). Kerbis states that "the effect of these omissions on the analysis is negligible" (1980:126), and for his purposes I don't dispute this. Unfortunately, for purposes of understanding precolumbian animal ceremonialism, as well as the dog as dietary factor, the effect is considerable. These few examples of animal ceremonialism contrast with animal ceremonialism reported from sites throughout Mesoamerica, as well as sites from Panama.

Turning to southern sources for evidence of animal ceremonialism and its significance, Cooke (1984) examined

the relationship between birds and men in Central Panama between 5000 B.C. and Spanish contact (1520) as evidenced in faunal remains and iconography found in archaeological sites and ethnographic/ethnohistoric data. At Sitio Sierra, in an eleventh century A.D. cemetery, a partial skeleton of a macaw (Ara macao) was found "heaped up over the tibia of an adult human" male (Cooke 1984:249). An adult female was found with a partial skeleton of a Crested Bobwhite (Colinus cristatus) alongside its head; the left femur had been removed after placement of the body in the grave, and was found to one side of an incense burner, beneath which was the left tibia of a paca (Cuniculus paca) (Cooke 1984:251).

A large number of dog (Canis familiaris) teeth have been recovered from Sitio Conte graves dating between 1500 and 1000 B.P. (Briggs 1986). These were used as decorations on clothing and also worn as bracelets and necklaces (Cooke in press:11). Domestic dog teeth with perforated roots have been found in graves at El Indio (Cooke in press:11).

Iguanids, Ctenosaura similis, also occur in faunal remains in Panama, as does white tail deer (Odocoileus), Cooke (In press:12).

Significance of Animal Ceremonialism

A number of possible interpretations may be given regarding animal ceremonialism. The interment of animals is one of the earliest hunting rites (Eliade 1976). It is believed that remains were interred in order to permit the animals reincarnation or as a sacrifice to supernatural beings. The belief that animals can be reborn from the bones is an archaic religious idea; the religious character of sacrifice to supernatural beings goes back to the Upper Paleolithic and is found in a considerable number of cultures (Eliade 1976:16). Cooke (1984) asserts that such human/faunal relationships might reflect kinship relationships as well as the desire for meat in the afterlife. This hypothesis compares favorably with interpretations which consider emphasis on certain animals as reflecting eponyms of lineages. The adult, male burial mentioned above, in addition to the macaw, was also associated with polished axes, a sericite bead necklace (one of the only examples of jewelry in the cemetery), and a flute made from a Brown Pelican (Pelicanus occidentalis). Cooke suggests that the individual possibly fulfilled a "ceremonial (shamanistic?) role in life" (Cooke 1984:249). Among the Bribris, animals are sacrificed during funeral ritual to accompany and help the soul (Bozzoli 1979:16).

This chapter detailed skeletal analyses and cultural features associated with the Nacascolo beach cemetery. I have attempted to interpret these remains through comparisons to archaeologic and ethnographic/ethnohistoric data. In the next chapter I discuss the grave offerings associated with the burials, and their role in mortuary behavior.

Chapter 5

ARTIFACT DESCRIPTIONS

Grave offerings associated with the Nacascalco beach cemetery consist of ceramic, shell, stone, and bone artifact assemblages. A total of 424 grave offerings have been excavated and analyzed; the percentage of each material assemblage presented below (Figure 5.1):

MATERIAL	NO. OF ARTIFACTS	PERCENTAGE
Ceramic	278	65
Stone	65	15
Shell	72	16
Bone	9	2
Total:	424	100

Figure 5.1.

Ceramic Analysis

The most common grave offering, ceramic vessels comprise 65% of the artifacts. Analysis of the ceramic assemblage, associated with Nacascalco burials, does not attempt a new classificatory system. Cemetery stratigraphy, developed through sequential intrusive

activities, does not produce a stratigraphy suitable for chronologic studies such as one finds in habitation sites where superimposition reflects temporal distinctions. However, notwithstanding heirlooms, ceramics associated with a given burial often reflect contemporaneity. I have therefore used established typologies developed by those who utilized seriated lots for their chronologies; Coe and Baudez 1962; Norweb 1962, 1964; Baudez 1967; Sweeney 1975; Accola 1978; Lange 1980; Healy 1980. I refer the reader to these publications for thorough discussion of typologies and chronology. Final chronologic determinations for each ceramic type as well as temporal designation for each period are based on reassessments made during The Denver Ceramic Conference [DCC] (Lange et al 1984).

One of the goals of this analysis is to determine temporal distinctions among the burials based on associated ceramics but this is not easily done. The majority of the ceramics are undecorated monochromes or utilitarian wares which usually persist in ceramic assemblages over extended periods of time.

While vessel form is used to discern temporal relationships within monochrome wares, working with the information provided by Baudez (1967) and Sweeney (1975)

it is difficult to assess chronologically some of the non-decorated monochrome wares. Temporal distinctions, often limited to changes in lip form, elude the archaeologist faced with mortuary practices which often entail vessel neck and rim removal.

In her examination of whole vessels from Hacienda Tempisque, Day noted the significance of the association of shape and design elements, the use of multiple designs, iconography, slips, colors, and the relationships between vessel forms, allowing identification of temporal markers and refined temporal sequences (Day 1984:77). The usefulness of this approach has been addressed by others working with ceramics in Greater Nicoya (Accola 1978; Lange 1980; Healy 1980), and has aided understandings of temporal change within Greater Nicoya ceramic types. However, most of the mentioned studies have focused on the polychromes which are, in general, easier to identify and often contain more temporally sensitive attributes than undecorated monochromes.

We can cross-date some of the ceramics based on similar vessel form, and design elements, found among different ceramic types. Regrettably, thorough analysis of the plain wares with resultant desired temporal distinctions requires comparison to the ceramics of the

entire Nacascolo site, entails a dissertation in itself, and cannot be accomplished fully in this dissertation. A precolumbian practice of breaking off the necks and rims of some vessels before burial, as well as post firing-pre burial burning of some vessels, as evidenced in the beach cemetery, further limits chronologic control. I can only provide basic descriptions, associations and must rely heavily on temporal placement of the decorated wares. With this in mind, I proceed with descriptions of the ceramic traditions for each period beginning with the Zoned Bichrome Period. Exceptions to this will be made in the presentation of the monochrome wares where I discuss similar types together even though they may not all be contemporaneous to demonstrate some of the problems encountered with type identification.

The following type descriptions reflect the above cited typologies as they pertain specifically to the Nacascolo beach cemetery data. The first name listed after each ceramic type indicates the originator of the type, any additional names are those who have discussed the type in subsequent studies. Vessel form typology follows Baudez's (1967:9) original vessel descriptions which were adapted by Sweeney (1975:61-63) and it is copied below for identification purposes to assist the reader. I do not however, agree with the functional

interpretations implied by Baudez's nomenclature nor Sweeney's adherence to and elaboration of this functional approach (e.g. "chicha jars"), in the absence of corroborating evidence. Although some large vessels are used today throughout Middle America for corn beer (chicha), it is unrealistic to call all such vessels chicha jars to the exclusion of containers for other liquids. Similarly, restricted neck "jars" may appear functionally suited for liquid storage but there is nothing to prohibit the storage of other materials; we shall see that Nacascolo beach ceramics were used for a variety of storage and burial purposes and that deriving vessel content from vessel form is often misleading and inaccurate. It is hoped that phytolith studies of vessel contents will shed light on questions of subsistence and storage, as well as demonstrate the types of flora provided the dead as grave offerings.

Vessel Shape Descriptions

Vessel shapes found in the Nacascolo beach cemetery are described below.

Form I: Jars, vessels taller than they are wide, with globular or subglobular bodies; concave, vertical or convergent neck with rim turned in same

direction (Baudez 1967: Pl. 7, 11, 13).

Form II: Jars with everted rims (Baudez 1967: Pl.7, 11, 13).

Form III: Bowls, vessels wider than they are tall, with shallow body or hemispherical and a divergent rim, either everted or thickened (Baudez 1967: Pl.8,11,14).

Form IV: Bowl with convergent rim, rim diameter less than the maximum diameter (Baudez 1967: Pl. 10, 12).

Form V: Bowl with shallow or hemispheric body with broad everted and thickened rim. A variety of Form III, Sweeney (1975) used this form for her shallow plates (Baudez 1967: Pl. 8, 14).

Form VI: Basin or bowl with shallow or hemispheric body with rim direct or thickened on the interior (Baudez 1967: Pl. 8, 12, 15).

Form VII: Cup with high vertical sides and rounded base (Baudez 1967:Pl. 10). No vessels of this form have been found to date in the Nacascolo beach cemetery.

Form VIII: Vessel with shallow body, concave neck either vertical or convergent (Baudez 1967: Pl.9, 12, 14).

Form IX: Basin bowl with shallow body, straight vertical neck, medial flange (Baudez 1967:12)

Form X: Shallow body vessel with straight convergent neck (Baudez 1967: Pl.9, 15).

Form XI: Bowl with shallow or hemispheric body and everted rim of irregular width (Baudez 1967: Pl.12).

Form XII: Bowl with hemispheric body and recessed rim (Baudez 1967: Pl.9, 12).

Form XIII: Tall cylindrical vessel with slightly concave vertical walls (Baudez 1967: Pl. 10).

Form XIV: Tripod bowl with everted walls (Baudez 1967: Pl.10, 15).

Form XV: Pyriform vase (Baudez 1967: Pl. 15).

Form XVI: Low vessel with very concave vertical walls and flat bottom, variant of Form XIII.

Sweeney (1975:63) lists additional vessel forms including the zapatero or shoe-shaped vessel common to Ometepe Island, the lake region, and throughout the Intermediate Area, bottles, and miniatures. No shoe-shaped vessels have been identified to date in the beach cemetery but they are reported in mortuary contexts from other areas of the site dating to the Middle Polychrome Period (Vazquez 1986).

Among Nacascolo beach cemetery ceramic vessels (Plate 47), the globular or subglobular olla is most representative. They range in size from large globular vessels (over 20 cm height and 24 cm. body diameter to miniature vessels (Plate 48) approximately 5 cm. height and of forms similar to those of larger size vessels. The largest vessels are of two types: restricted neck and open vertical neck globular ollas (Plate 47), in all beige (Los Hermanos Beige or perhaps Sarnoso Beige), some with red rim (Los Hermanos Beige), red with beige bottom (Juanilla Red on Beige), and red ware. A medium size; and a smaller; miniature ollas; "escudilla" bowls, plates "budares", and modelled effigy vessels.

Miniatures

Miniatures are well known from the end of the Zoned Bichrome through Early Polychrome Periods and disappear

during the Middle Polychrome Period (Juan Vicente Guerrero, personal communication; no miniatures were found in Middle Polychrome Period excavations at La Ceiba. It has been suggested that miniature vessels found in tombs at the Aguacaliente Site in Cartago were perhaps placed symbolically for a special status child found inside (Vazquez and/or Snarskis 1985:2). These are Middle and Late Polychrome cist tombs (tumbas de cajon) although evidence from all four ceramic periods may be found. Miniature vessels as mortuary offerings are characteristic of Late Postclassic sites in west Mexico (Meighan 1972:17-18), and miniature vessels of Capacha style date to 1000 B.C. or older (Meighan 1972:20). Miniatures are found in Ecuador dating to the Guangala Phase (Bushnell 1951).

Zoned Bichrome Period Ceramics

Zoned Bichrome period ceramics have been described by Coe (1962); Coe and Baudez (1961); Norweb (1962, 1964); Baudez (1967); Lange (1971a, 1980); and Sweeney (1975); chronologically, the period dates B.C. 600 - 500 A.D. (Lange et al 1984:209). The ceramics consist of monochrome and bichrome wares, sometimes with plastic decorations of incisions, punctations, impression, or modelled appliques. Zoning, burnishing and polishing surfaces to a high luster is characteristic of the period;

handles are lacking and the few supports are conical and solid (Sweeney 1976:38).

Monochromes

Espejo Black (Sweeney 1975:76-78) Highly polished black vessels, some have incisions with white paint rubbed into the incisions. May be the same as Baudez's Delirion Black (1967:96-97), although Baudez's type description does not include incisions. Sweeney's Form 11, from Matapalo and Cahuite Escondido, consists of constricted neck jars and several miniatures which she considers very fine and skillfully done.

Chronology: Sweeney found Espejo Black during Monte Fresco and Chombo phases of Santa Elena Peninsula and Tamarindo, dying out by the Early Polychrome; Baudez attributes Delirion Black to Catalina Phase, equivalent to Orso Phase (300 B.C. - 300 A.D.), Culebra Bay Sequence (Lange and Abel-Vidor 1980).

Nacascolo sample: Artifact 101, a miniature globular vessel with incurving rim, vertical incisions with white paint rubbed into incisions (Pl.48 a); associated with Burials 30, 18a, 18b; an adult female and two infants. Artifact 17 (Plate 49a), has double horizontal incised lines along the lower registry which frames the supports with a quadrangular pattern; associated with Burial 19,

infant. Artifact 124, a highly polished black/brown olla, (Plate 49 b) fits Baudez's Group 1 description for Delirion Black, which may also be related to Lothrop's (1926) Chocolate Ware. Art 124; associated with Burial 71, an old adult, male.

References and Comparisons: Sweeney 1975:Pl 21:A-C.

Sweeney's example of Espejo Black miniature also had grooves filled with white paint whereas incised wares with white pigment in the incisions or grooves are rare in Rio Naranja data (Norr 1978:8). Sweeney noted the Espejo sherds were small and the only distinctive feature besides the polish is a flat horizontal rim; one of the Nacasclo samples has a flat horizontal rim (Art. 17, Plate 49a) whereas the other (Art. 111, Plate 48a.) has a rounded incurving rim. Sweeney suggests that Espejo Black is representative of the Formative polished black trait described by Pina Chan in 1971 (Sweeney 1975:364).

Beige and Brown Wares

Apompua Modelled (Healy 1974, 1980:88-91; Sweeney 1975:273-274). Principal identifying modes: grooved, applique strips and modelling on vessel exteriors. Modelling is the most common form of decoration, usually in the form of crude limbs (arms and legs) and facial eyes, mouth, and nose representations of humans and

animals.

Chronology: Popular during the Zoned Bichrome Period and continues into later times in sharply reduced quantities and frequencies, Zoned Bichrome Period 600 B.C.- 500 A.D. (Lange et al 1984:209). Sweeney's chronology places Apompua Modelled much later in Middle and Late Polychrome Periods, Dos Cientos and La Cruz Phases. Healy (1980:19) indicates applique motifs from Rivas are considerably earlier than those of Linares's San Lorenzo Phase in the Chiriqui region.

References and Comparisons: The most common color in Sweeney's material was cinnamon brown to red brown. The Nacascolo example is dark brown (Plate 49c), this may be the result of post production burning, an apparently common mortuary practice in the Nacascolo beach cemetery. Lothrop noted some similarities with Curridabat Ware and Stone Cist Ware of Highland Costa Rica (Lothrop 1926:346-352 as cited in Healy (1980:91). The DCC determined Apompua Modeled as having northern emphasis.

Nacascolo sample: (1), Artifact 31 (Plate 49b) associated with two other vessels; one Cabuyal and one Los Hermanos Beige. Identified with Burial 6, a scatter of long bones, dates to Middle Polychrome Period (700-100 A.D.)..

Congo Punctate (Baudez 1967:61-62; Sweeney 1975:96-97)
Globular vessels distinguished by one or more rows of

punctations on an unslipped surface, color beige to red-brown. The surface treatment is sometimes smooth or uneven; those made of Yayal paste are smoothed and floated while those of Monte Cristo are rough and uneven.

Chronology: Sweeney records Congo Punctate at Matapalo during Monte Fresco Phase (B.C. 300-300 A.D.) and Baudez found it somewhat later in the Ciruelas Phase (Linear Decorated period A.D. 300-500) in the Tempisque Valley; coeval to Orso and Mata de Uva Phases in Culebra sequence.

References and Comparisons: Hartman 1907 fig.33; Lothrop 1926: pl. LXIIa; Baudez 1967: pl.18 a.b.f., pl.28 a.b; Sweeney 1975: pl.19 A,B,C,D,E,F,G.

Nacascolo sample: (2) both rough and uneven (Monte Cristo paste); Artifact 16, olla, found inside Artifact 14, Juanilla Beige on Red olla; together with Artifact 15, Los Hermanos Beige, all associated with Burial 1. Art.352, olla with conical supports and vertical handles, associated with Burial 110, a middle adult male.

Yayal Brown (Baudez 1967:112-115; Sweeney 1975:170-175)
Form II globular to subglobular olla with rounded, flattened or bevelled lip. Decoration lacking except for an occasional applique. Sweeney notes several examples with vertical strap handles attached from rim to the shoulder; strap handles; plain; flat; and horizontal. Applied stirrup handles; with one to or two fillets

perpendicular to the point of juncture on each side.

These fillets may be left unadorned or they may be decorated with applied fillets or more commonly impressed with fingertips which leave a row of punctations.

Chronology: begins in the Monte Fresco Phase (B.C.300-300A.D.) but becomes the dominant plainware all through the Matapalo phase (A.D.500-800); coeval to Orso Phase through Mata de Uva and Culebra Phases in Culebra Bay Sequence.

References and Comparisons: Baudez found Yayal at La Guinea and one pot at Bolson (Sweeney 1975:175; Baudez 1967:pl.34 a,c; pl.35a,c,f; Sweeney 1975: Plates 34:A; 47:H-J; 67:A,B,D; 68:B,D,E,F,G; 80:H).

Nacascolo sample: Artifact 129 (Plate 50b), small beige globular vessel with incurving rim and stirrup handle with applied fillet at center of handle which has several vertical incisions. Art.262, olla with vertical handles, associated with Burial 76 and ceramics of Tola, Guinea, and possible Leon Punctate.

Red Wares

Baudez (1967) described several groups of red slipped utilitarian wares from Tempisque: Chaparrita Red (Zoned Bichrome), Urruela Red (Zoned Bichrome-Early Polychrome), Chanco Red (Linear decorated), Mansion Red (Early-Middle

Polychrome), Piches Red (Middle Polychrome), Moreira Red (Middle Polychrome), and Veronica Red (Middle to Late Polychrome). Sweeney (1975) added several red ware types: Victor Red, Zayas Red and Armas Red. Healy (1980) after consultations with Lange, did not think an intensive and time consuming study of the thousands of red ware sherds would be fruitful and therefore designated only two varieties: Rivas and Leon for his Nicaraguan red wares which are analogous to those of Baudez (Healy 1980:208). Baudez's and Sweeney's types however, are more temporally sensitive and therefore more useful in seriating the burials.

Typing the red wares is problematical and similar to those encountered with the other monochrome wares. I am confused by conflicting type descriptions and type identifications in plate photographs from which to judge the beach cemetery red wares; it is difficult to discern types and temporal considerations due to this limitation. However, I will describe the red wares as they appear to relate to established types and note conflicting data where indicated.

Chaparrita Red (Baudez 1967:55-57; Sweeney 1975:110-113)
Slipped on exterior and sometimes interior with red-orange or raspberry-red color; noted for small conical supports

slipped red, and a variety of vessel forms.

Chronology: Characteristic of Monte Fresco and continues into the following Las Minas Phase, coeval to Orso and Mata de Uva Phases in the Culebra sequence (Lange et al 1984). Baudez indicates Chaparrita and its counterpart, Monte Cristo Beige, dominated the plain wares at this time and were replaced by Chonzo Red and Los Hermanos Beige in the latter part of the Zoned Bichrome period. Like the beige wares, the two red wares differ only in lip form, while vessel shapes essentially remain constant.

References: Baudez (1967:Pl. 48:A,J; Pl. 24:B,G,J) found Chaparrita at Bocana, Ortega and La Guinea; Sweeney (1975: Pl.36:D) found Chaparrita at Matapalo.

Nacascolo sample: Artifact 149, Form IIc, also similar to Baudez's Chanzo form (Pl.28:E) but the Nacascolo vessel has a more outcurving rim. Associated with Burials 51 and 52 and five other ceramic vessels; two Charco, one Los Hermanos Beige or Monte Cristo Beige, one almost purple vessel with cross incision on pedestal base (Plate 51a). Radiocarbon date of B.C. 575 +/-120 obtained from carbonized wood associated with these ceramics. Art. 176, conical support tripod bowl associated with a Charco Black on Red tripod olla and Burial 73, a middle adult, female.

Urruela Red (Baudez 1967:94-96; Sweeney 1975:)

Red slip interior and exterior or only exterior. No

decoration. Group 1 consists of miniature vessels.

References: Hartman 1907:fig.20; fig.41.

Chronology: Baudez found Urruela Red during Catalina and Ciruelas Phases coeval to Orso and Mata de Uva in Culebra sequence (Lange et al 1984).

Nacascolo sample: Both miniatures (Plate 48 C and D). Art 247 associated with Burial 77 old adult, female.

Chancho Red (Baudez 1967:107-109; Sweeney 1975:
Red slipped interior and exterior or only exterior.
Conical supports.

Chronology: Baudez indicates Chonzo Red popular during Ciruelas Phase coeval to Mata de Uva in the Culebra sequence.

Mansion Red (Baudez 1967:115-116; Sweeney 1975:176-181)
Largely undecorated red slip vessels with conical supports. Mansion Red is the dominant plain red ware of the Matapalo Phase of Early Polychrome Period and is found in large quantities at La Guinea (Baudez 1967:115). Appears somewhat later than Yayal Brown in all Matapalo pits (Sweeney 1975:181). Sweeney pictures a frog effigy vessel listed as Mansion Red but no effigy forms are indicated in either her or Baudez's type description. I cannot determine the exact error; either the frog vase caption is mislabeled or the vessel was mistyped. Of the

red ware type descriptions provided by Baudez and Sweeney, zoomorphs are only identified for Piches Red Group XI (Baudez 1967:151-154; Plate 37:C); this form is very similar to the Nacascolo zoomorphs. The major problem is temporal assignation.

Piches Red (Baudez 1967:151-154)

According to Baudez, Piches Red is characteristic of Palo Blanco and Bebedero Phases of Middle and Late Polychrome Periods; and was the most important culinary type of these two phases replacing Yayal Brown. Silvia Salgado and Juan Vicente Guerrero (personal communication) consider Piches too late for the Nacascolo red wares and suggested other red wares, but none of the type descriptions fit the Nacascolo zoomorphs as well as Piches. The Nacascolo zoomorphs are associated with Guinea Incised and would appear to be earlier than the chronology proposed by Baudez. Baudez assisted this author in identifying the Nacascolo ceramics after the 1989 field season, and saw nothing wrong with identifying the red ware zoomorphs as Piches. Baudez (personal communication) indicated that whereas Piches is characteristic of the later phases, it first appears at the beginning of the Early Polychrome Period at Papagayo. Considering the proximity of Nacascolo and Papagayo Sites, and the demonstrated similarity in ceramics, I see no reason to consider the Nacascolo zoomorphs as anything other than Piches Red,

with an Early Polychrome Period designation. The Nacascolo Piches zoomorphs are few, well made, and apparently somewhat restricted among Nacascolo inhabitants. This suggests some sort of relationship between the two sites, possibly along familial lines. Nacascolo sample: Zoomorphs, birds, fish, possible human represented (Plates 48b, 52, 53). Art 64, pedestal base fish, Lenguado, family Bothidae; Art.5 frigate bird (Fregitidae), has something unidentified in mouth, conical supports; Art.6 miniature anthropomorph; associated with ceramic types of Guinea Incised, Tola, and Los Hermanos Beige, all grave offerings of Burial 25, an old adult, male. Art. 115 possibly an owl, pedestal base, associated with cache 3.

Red on Buff Wares

Red on buff wares are common throughout Central America in all time periods. Baudez (1967) lists two utilitarian types pertinent to this study: Monte Cristo Beige and Los Hermanos Beige; Sweeney (1975) added another type: Juanilla Red on Buff. A review of these three type descriptions confuses more than enlightens the average analyst since Monte Cristo Beige and Los Hermanos vessel shapes are very much the same, varying only in lip form and certain adornments found on Monte Cristo (Sweeney

1975:365). All are brown, beige or rosy beige some with red rims, some without, some with red slip interior, partial exterior, some without; this is even more frustrating when the Nacasclo ceramics show evidence of having been burned. When all the Nacasclo beach cemetery vessels were assembled, they were distinguishable from each other and I have typed them accordingly. As I understand these type descriptions, I am calling the brown-beige ollas with red slip lip and/or rim Monte Cristo Beige (Baudez 1967); the buff or beige with red slip rim and interior as Los Hermanos Beige; and the orangy-buff-buff vessels with red rim and red slip covering 1/4-2/3 of vessel, on the exterior and/or interior as Juanilla Red on Buff (Sweeney 1975), because the Juanilla type description more closely resembles these Nacasclo vessels than the others, and is readily distinguished from the 1/3-2/3 red-slip interiors described for Monte Cristo Beige (Baudez 1967). While Sweeney (1975:109) says Monte Cristo Beige is analogous to Juanilla Red on Buff at Cahuite Escondido, she apparently considered it distinctive enough to originate the new type and the Nacasclo ceramics support her decision.

Monte Cristo Beige (Baudez 1967:51-55; Sweeney 1975:105-109). Beige to rosy beige vessels undecorated except for some red rims and a few sherds with applique dots and

adornments. Baudez has a number of forms: Form I (Baudez pl.7:1&11 body C), globular with concave divergent or vertical neck, juncture with body, uninterrupted or at an angle, rim thickened to exterior and round or progressively thickened, lip rounded. Baudez noted about 1/3 are plain bluff, 2/3 have a red rim and/or interior neck. Form II: 2/3 of this group are plain bluff the remaining have red painted rims. Form III red rim and or interior. Form V, some red rims; shallow plates such as these seem to be an early manifestation in Greater Nicoya (Sweeney 1975:108). Form VI open bowls.

Other forms: several bottle shaped necks with rims, very much eroded, vertical necks, direct rims, lip rounded.

Chronology: Baudez (1967:55) claims that the Monte Cristo is the "most important culinary type" of the Catalina phase. It continues into the Ciruelas Phase, then loses its premier position to Los Hermanos Beige; coeval to Orso and Mata de Uva Phases in the Culebra sequence (B.C.300-500 A.D.).

References and Comparisons: Monte Cristo Beige is one of the many buff ware types (with or without rim) that occur in Mesoamerica and Lower Central America. Baudez 1967: Plates 7,8,9,10,24; Sweeney 1975:Pl.21 E.

Juanilla Red on Buff (Sweeney 1975:130)

Distinguishing features: simple undecorated jars and

bowls; low, symmetrical conical supports, some higher with truncated bottom (pl.67:H) and high hipped supports, asymmetrical conical supports (pl.67 k), some solid conical supports with large round punctations that almost completely pierce the support, confined to the Early and Middle Polychrome periods. One mammiform support from the Early Polychrome period component. Appendages: Strap handle and plain horizontal strap the majority type; vertical straps are rare; oval tabs at lip or on shoulder are infrequent. Asymmetrical fat loops set horizontally with their upper surface smaller than their lower surface and a rounded finger hole, have a period of popularity coeval with the punctated nubbins, Sweeney believes they come from the same vessel. Rope carrying lugs occur infrequently.

Decorations: Juanilla may be entirely buff but this is rare and it usually has characteristic red paint: 1) on both interior and exterior lip; 2) on rim and upper or lower half of body; 3) on rim and lip of exterior and entire interior (bowls); 4) on rim and lip of exterior and neck of interior of exterior (jars); 5) one form VI bowl has red rim and black lip. According to Sweeney, it may have applique and punctate decoration. At the juncture of neck and body of several large jars is a horizontal applique fillet with finger-impressed punctations. Occasionally an applique pellet is placed on a jar neck or

handle. There is one tab handle with a human face marked with incisions (PL.69b). The Nacascolo Juanilla vessels (Plate 51 c,d,e,f) are distinct from the Monte Cristo Beige and Los Hermanos Beige in their distinct color (beige to orangy-beige) with red slipped rim and slipped or partially red slipped interior and exteriors, somewhat sloppily applied.

Chronology: very long lived plain ware type of pottery extending from the Zoned Bichrome Chombo Phase to Late Polychrome times coeval to Orso Phase of Culebra sequence. It is superseded by Ramos Polished Plain in the last phase of the Late Polychrome (La Cruz Phase in Salinas Bay and Santa Elena Peninsula).

References and Comparisons: Sweeney states that the large vessels are "probably chicha jars" (Sweeney 1975:132). The functional interpretation of chicha jars for these large vessels is speculative. Similar vessels are universal in Mexico from pre-classic to historic times and can be purchased today in Libertad market in Guadalajara (Meighan, personal communication) and Oaxaca (personal observation); while present day observation attests to their use with liquids, even chicha, and many archaeologists have continued such functional interpretations as chicha jars (Hoopes 1980), however, there is no conclusive evidence to indicate their exclusive use as chicha jars.

In the Nacascolo beach cemetery large vessels such as these have been used as infant burial urns (Plate 47a); however, not all of the large vessels are infant burial urns (Pl.47b) and infant urn burials are not restricted to large vessels.

Nacascolo sample: Bowls (Plate 51 c,d,e), some with conical shape, and more cylindrical supports. One tetrapod vessel, Art. 296 (Plate 51b) associated with infant Burial 93 and a Los Hermanos Beige olla, is similar in form to one from Chiapa de Corzo published by Lee (1969:Figure 67:112). The Chiapa vessel is somewhat smaller, has thicker walls, and is made of "fine-grain limestone" (Lee 1969:111) whereas the Nacascolo example is ceramic. The Chiapa de Corzo vessel dates to the Horcones Phase of the Early Protoclassic approximately B.C. 100.

Los Hermanos Beige (Baudez 1967:105-107; Sweeney 1975:118-122) Buff or beige color undecorated vessels except for occasional red rim and simple applique bands or pellets. Solid plain conical supports and hollow hipped conical supports; mammiform supports on vessel with four vertical handles which should date to Early Polychrome period based on the mammiform supports found by Sweeney and dated to this period.

Chronology: Baudez (1967) indicates this culinary type characteristic of the Ciruelas Phase. Sweeney found Los

Hermanos Beige from the end of Monte Fresco Phase and through the Las Minas Phase into the Matapalo Phase at the Matapalo site; coeval to the end of the Orso Phase through the Mata de Uva and into the Culebra Phase (approximately 200-700 A.D.). One of the best ways of ascertaining contemporaneity is the supports.

Illustrations: Baudez 1967: pl.57 c, pl.67 h.j.k. pl.69 a.b.c); Sweeney 1975: Plates 67:C,F; 68:A; 72:B-D.

Nacascolo sample: Well represented in the beach cemetery and includes several vessel forms; globular (olla); conical, hipped support tripod bowls (escudilla; Pl.54); budare (Pl.55a); a shallow dish with tab handle, possible incensario (Pl.55b) a mammiform tripod support vessel with four vertical handles suggesting a cord or rope may have passed around the vessel (Pl.54b); Sweeney indicated similar "lug handles" in her Juanilla material but the Los Hermanos Beige designation is more suitable for the Nacascolo vessel.

Based on rim comparisons, it is possible that some of the large beige vessels found in the cemetery are Sarnoso Thick Paste (Baudez 1967) rather than Juanilla or Los Hermanos Beige types.

Cervantes Incised and Punctate (Baudez 1967:109-110; Healy 1980). Alternating bands of red slip and multiple

fine line incising and punctating. Baudez indicates the two types of decoration are the same type with the same chronology.

Chronology: Catalina and Ciruelas Phases; coeval to Orso and Mata de Uva Phases of Culebra sequence (300 B.C.-300 A.D.).

References and Comparisons: Appears to be part of a widespread Zoned bichrome tradition related to the scarified wares of the Chiriqui region of Costa Rica and Panama (Holmes 1888) and western Nicaragua (Lothrop 1926:p.cxiv as cited in Norr 1979). Baudez lists two vessels similar to Cervantes from Las Huacas: Hartman 1907:35, no.4, pl.II, fig.3; p.36, No.7, pl.II, fig.6; Baudez 1967:pl. 32:A.D. Healy relegated this type to a variety of his Rivas Red. The Nacascolo example is distinct enough to support the Cervantes type and Baudez's Linear Decorated Period

Nacascolo sample: Art 261, conical tripod support bowl, three bands on punctations on rim alternating with red slip. Lack of slip on vessel bottom in the form of a triangle. Associated with Burial 50, 12-13 years old.

According to Norr, the predominant monochrome wares for her Zoned Bichrome material are red slipped engraved and incised wares. The slip is often thick and poorly polished. Designs are strictly geometrical and occur on

the shoulders of jars and on the necks of carinated tripod bowls.

The Nacascolo ceramics show close relations to Bolson and Papagayo sites in ceramic types of the Linear Decorated Period (Baudez 1967). The DCC (Lange et al 1984:201) determined that the Linear Decorated Period (Baudez 1967) was not evidenced throughout Greater Nicoya and replaced the period with a phase (Ciruelas) in the Tempisque Valley sequence, coeval to the Mata de Uva Phase in the Culebra Bay sequence (Lange and Abel-Vidor 1980:4). Nonetheless, the Nacascolo data compare favorably with Baudez's material of this period. Since one of the goals of this dissertation is to seriate the burials based on the associated ceramics, any and all temporal refinements are considered worthwhile. Dating to 300 - 500 A.D., this phase is considered equivalent to the Mesoamerican Early Classic.

Characteristic of this period are lines singly or in groups, painted on the vessel. Most common is the multiple brush method probably inspired by the Usulután process resist technique which is contemporaneous (Baudez 1967). Plastic decorations continue, but punctate and impressed types disappear. Some handles on jars appear; the supports continue to be solid and conical. Many

earlier types were still made during this time and new types are the black on red wares (Charco, Puerto, Mosca, Tola, Lopez, and Cortes), Zelaya Trichrome, and Guinea Incised.

During the Mata de Uva Phase, Victor Red (Sweeney 1975) and Gamboa Red Ridged (Sweeney 1975) appear. They are thin red wares with distinct color and shapes which are later seen in Urcuyo White on Red and Chavez White on Red (Sweeney 1975:370).

Negative Resist

Negative resist wares appear at this time; one sherd (black on brown) is reported from this phase by Sweeney (1975:371). Based on a pattern consisting of circles on a horizontal row (Sweeney 1975:Pl.65A), she does not equate it with the Usulután type, and it differs from an Usulután resist vessel found at Matapalo in association with Early Polychrome ceramics (Sweeney 1975:371). According to Longyear (1966); Glass (1966) and Sharer (1968). The Usulután technique is viewed as a Late Preclassic marker emanating from El Salvador (Sweeney 1975:371); Vaillant (1934) lists this technique in his "Q Complex" as indicative of Middle American Formative cultures.

Negative resist technique is found throughout the Intermediate Area (Willey 1971) as well as in west Mexico (Meighan 1976) and Ecuador (Bushnell 1952; Paulson 1977); while colors vary, the technique employed is the same.

Sweeney's black on brown resist design compares favorably with a black on red resist vessel found in the area of infant burials and directly associated with a plain tripod metate and ellipsoidal mano, tubular jade bead and four coral beads. This is one of four examples of negative resist technique found in the Nacascolo beach cemetery (Plate 56). Although deteriorated, the design clearly shows a pattern of circles in a horizontal row and several vertical lines. The other black on red resist design is found in the upper registry of a ridged vessel with a single incised vertical slit on each hipped conical support (Plate 5), this was associated with an Espejo Black miniature vessel (Burials 30, 18a,b). The underside of one conical-hipped support Guinea Incised vessel (Art.334) associated with Burial 106 also exhibits a geometric black on red resist design. This was found with ceramics of Leon Punctate, Juanilla Red on Beige, Los Hermanos Beige and red ware vessels. The final resist technique design is white on red (Plate 57) and was found with ceramics of Leon Punctate (Baudez 1967), Tola (Norweb 1962), Juanilla red on Beige (Sweeney 1975), and a plain

tripod metate and ellipsoidal mano, indicative of the end of the Zoned Bichrome Period (see Burial 104).

Black on Red Wares

Of the five black on red ceramic type descriptions, several are found in the Nacascolo beach cemetery; Charco Black on Red is readily distinguishable from the others, as is Tola (referred to as Nandaime by Lothrop 1926 and Lopez by Baudez 1967); Mosca Black on Red and possibly Cortes, however, are somewhat problematical but should become clearer after this discussion. Charco differs from Tola and Mosca and Cortes in the width of the lines (Mosca's are wider; Tola is bounded by white lines and has white dots). Lange (1971:164) believes the Mosca type (Norweb 1964) vessels are actually Tola vessels which have lost the white paint due to deterioration but I don't believe this to be the case. While many Tola vessels do exhibit deterioration of white paint, some Nacascolo beach cemetery black on red vessels, nearly identical in form to the Tola vessels, with a single black line on the upper registry but not as deteriorated, never had white paint and do not support Lange's interpretation; to the contrary, it is clear that some of these black line on red vessels, common to small tripod vessels and medium size jars, are not the result of deterioration but are separate

ceramic types.

Charco Black on Red: Charco Variety (Baudez 1967:83-86; Sweeney 1975:149-152; Accola 1978:66; Lange et al 1984:209).

Characterized by black line designs on red vessels; three or four parallel lines circumvent the shoulder with similar lines (sometimes clusters of interspaced lines) running vertically from the shoulder to the bottom of the vessel. Four vessel forms: 1) globular bowl with restricted orifice and protruding lips; 2) open bowls; 3) incurving bowls; 4) small tripod bowls. Accola noted the similarity in vessel form of Charco and several red slipped monochromes with similar paste and form (1978:66).

References and Comparisons: DCC determined Charco: Charco Variety, Pan-Regional during Zoned Bichrome Period.

Nacacolo sample: (Plate 59) Associated with Burials 29, 44, 51 and 52, 55, 79, 94: all ages and both sexes.

Charco: Puerto Variety (Norweb 1964:559; Healy 1980:201-205) Principal identifying modes: Red slip with black rectilinear designs on vessel interiors, particularly a "hanging line" motif, sunburst patterns, crosses, X's, and a stepped pattern; tripod bowls with thickened rims; some grater bowls with unslipped roughened interior, usually encircled by a black line; stubby tripod supports.

References and Comparisons: According to Healy (1980:204-205), Puerto is present in all Rivas excavations except the Middle-Late Polychrome site of Santa Isabel "A." A similar though not identical hanging line motif was reported in Charco Black on Red description of Baudez (1967). DCC determined Puerto Variety as having northern emphasis.

Chronology: Healy noted the almost exact chronological duration of Puerto and Charco varieties, beginning in the late Zoned Bichrome Period and diminishing in the Early Polychrome Period.

Illustrations: Healy (1980: Figs. 88,89,90,91);

Nacascolo sample: (2) Artifact 11, a tripod grater bowl with stubby supports (vessel form very similar that pictured in Healy (1980:fig.88) associated with Burial 11. Art.308, an incurving rim bowl with geometric design, associated with Burial 95. Healy's Puerto ceramics are limited to the tripod bowl form; Artifact 308 has somewhat different black line design on vessel exterior (Plate 58). Artifact 287 (Plate 59a) has black geometric cross-hatching on upper body of vessel and seven red horizontal wavy lines on the vessel neck; this appears to a mix of Charco Puerto Variety and possibly Cabuyal. This vessel was associated with Burial 85, a young adult, male.

Mosca Black on Red (Norweb 1964:559; Lange 1971c:152).

Black lines on red slip. Differs from Charco in the width

of its lines, and does not have the white lines and spots found on Tola. Lange argues that Mosca is simply Tola with the lines weathered away. This may be the case sometimes; however, I think Tola without white is actually Mosca because there may be a difference in forms, the Mosca vessels having a slightly outcurving rim.

Nacascolo sample: Same vessel forms as Charco, a slight difference in tripod bowls with the Mosca vessels slightly outcurving and the Tola incurving. One olla (Artifact 175) with a single black line just below neck, and one around the mid-section of vessel.

Tola Trichrome: (Norweb 1964:559; Lange 1971:152; Accola 1978:80-81; Healy 1980:227-232).

First illustrated by Lothrop (1926:fig.112b) under the heading "Nandaime Ware." Same as Baudez's Lopez Polychrome (1967:99-101). Red slipped jars, cuspidors hemispherical bowls, tecomates, effigies, and grater bowls with distinctive graphite black banding on exterior or on interior part of outflaring rim, occasionally, elaborated by thin white lineal designs over or around the black banding. Some of the Nacascolo vessels have white dots on top of the black band, which is bordered by a white line above and below the black band. This appears to be confined to the small tripod bowls and incurving bowls. Chronology: Referred to by Haberland (1969:232-234) as an

important horizon marker of the Early Polychrome Period (Healy 1980:230); Baudez places Tola during Ciruelas phase coeval to Mata de Uva Phase (300-500 A.D) of Culebra Bay sequence.

Illustrations: Lothrop (1926: fig.112b); Baudez (1967:pl.33:A,B,C,D,E); Healy (1980:Figs. 104,105)

Nacascolo sample: Well represented in Nacascolo burials. This ceramic type has been found alone and associated with as many as 14 other vessels in more prestigious burials, with individuals of all ages and both sexes. Tola with white dots (Plate 60) is associated with other vessel types of Carrillo, Charco Red on Black, Juanilla Red on Beige, and Red ware. Several effigy vessels occur, all birds, one identified as Crax rubra (Art.112, Burial 34, Plate 61). One incurving bowl has double row of black lines bordered by white lines and white dots on the black.

Zelaya Trichrome (Baudez 1967:98-99 Pl.23 C,D; Sweeney 1975).

Principal identifying modes are multiple vertical black lines painted on the unslipped neck; the lip and lower 2/3 of vessel slipped orange-red on a complex silhouette bowl form with strap supports in V or U shape with the centers closed. The carinated bowl form is called a "cuspidor" by Baudez. Surfaces are slipped on both sides in red-orange color and are not highly polished.

Chronology: Baudez found Zelaya Trichrome characteristic of the Catalina Phase diminishing in the Ciruelas Phase; Sweeney (1975) found Zelaya Trichrome in Tempisque and Santa Elena Peninsula during Monte Fresco, Las Minas and Chombo Phases, equivalent to Orso and Mata de Uva phases (300 B.C.-500 A.D) of Culebra Bay sequence.

References and Comparisons: Baudez (1967: pl.23c,d); Lothrop Lothrop 1926:224 fig 116b; Sweeney pl.75:B. DCC determined Zelaya has southern emphasis (Lange et al 1984:209).

Nacascolo sample: Artifact 178, classic cuspidor shape (Plate 62), associated with Burial 55, an old adult, female. This vessel also has a sacrifice hole. Artifact 355, bowl, associated with Burial 112, a middle adult, male.

Guinea Incised: Type originated by Baudez (1967:73-79) who identified principal modes as geometric incisions on red, maroon, or brownish slipped vessels with bulbous or conical hipped supports or pedestal base. Some vessels incorporate negative resist painting (black). Sweeney 1975:204-213; DCC Guinea Variety; Usulután Variety (Healy 1980:239); Gutierrez Variety (Sweeney 1975:217-223).

Nacacolo sample: All three varieties are found in the beach cemetery (Plates 62 and 63). Associated with Burials 25, 28, 57, 106, all adults, both male and female.

Two pedestal base bowls, one with turtle effigy (Art.88) associated with Burial 25 (Plate 63). One effigy of an unidentified mammal on incurving bowl, supports missing, associated with Burial 57 (Plate 63). Two high-hipped conical support bowls (Arts.332, 334), one with geometric negative resist (Art.334), both associated with Burial 106.

To conclude this discussion of the Zoned Bichrome Period, in comparison to South America and Mesoamerica, Greater Nicoya lacks solid figurines during the Zoned Bichrome Period (Lange et al 1984:202). In comparison to Gulf of Fonseca, Baudez noted nothing in common other than general Late Preclassic social similarities; no comparisons exist on the typological level (Lange et al 1984:202). During the Orso Phase (B.C. 300-300 A.D) of the Culebra sequence (Lange and Abel-Vidor 1980) ceramic types include Monte Cristo Beige, Chaparrita Red, Congo Punctate, Rosales, Bocana Toya, Zelaya Bichrome, Cervantes Incised and Punctate. Charco, Cobano, Las Palmas, and Zelaya Bichrome are characteristic (Baudez 1967:206). Usulután ware is contemporaneous with this phase as is Ulua Bichrome of Playa de Los Muertos (Baudez 1967:206).

Baudez distinguishes between trichromes such as Tola and Carrillo of the Ciruelas or Mata de Uva phase and true

polychromes of the following Early Polychrome period (Lange et al 1980:202) but I refer to Carrillo as Early Polychrome in accordance with the DCC (Lange et al (1984). Snarskis (1984) sees Carrillo as an outgrowth of Tola. The two types share similar vessel forms, in particular, a tripod bowl with solid conical supports, an animal effigy head, two wings, and tail appliques (Plate 61); also found among red wares, this is iconography of the Early Polychrome Period.

What is remarkable in Zoned Bichrome Period ceramics excavated from the Nacascolo cemetery is the lack of early, Loma B Phase (B.C.600-300) types such as Bocana, Toya Incised Trichrome, and Rosales Zoned and Engraved which are found throughout Greater Nicoya and considered important mortuary offerings. Only eight Bocana Incised sherds have been found in other areas of Nacascolo (Vazquez 1986), and these are not in mortuary contexts. One radiocarbon date of 810-410 B.C. is associated with Charco Black on Red and Red Ware ceramics; there is no question the site was occupied at that time. The whereabouts of the owners of Bocana and Rosales Zoned and Engraved have not as yet been encountered in the beach cemetery. The question remains, where then are the people responsible for the earliest ceramics buried? I suggest evidence of their remains exist in unexcavated portions of

the cemetery and will someday be unearthed.

Early Polychrome Period Ceramics

Early Polychrome Period (500-800 A.D.: Lange et al 1984). True polychrome tradition replaces earlier monochrome/bichrome/trichrome traditions although many monochrome utilitarian wares continue. Horizon markers: Grater bowls (Leon Punctate) and white paint on red slip (Chavez and Urcoyo White on Red). Open bowls, necked jars, mammiform and other hollow tripod supports supplement conical feet. Handles and flanges occur; applique and modeling become popular and are common on handles, and as adornos (applique effigies on vessel sides). Incising and polychrome painting, usually black and red on buff slip or plain bluff paste are the most popular decorative modes; oval bowls and zoomorphic adornos occur.

In addition to the introduction of true polychromes, the Early Polychrome period begins a change in the iconography represented in the polychrome ceramics which, according to Day (1988) incorporates new ideas and techniques, and is reflected in the regional chronologies of Coe and Baudez (1962), Baudez (1967), Sweeney (1975) and Healy (1980).

The diffusion of the polychrome tradition into Nicoya remains a topic of debate. Polychrome vessels are found in the northern and southern areas: coastal Peru, Ecuador, Columbia, Panama, and Venezuela as well as west Mexico, southeast Veracruz and the Maya area, could have been the source of this diffusion (Day 1988). Two of these regions, the Maya and the equatorial areas, share similar characteristics of Greater Nicoya's early polychrome tradition (Day 1988:142). This is based on studies of the two oldest polychrome ceramic types Carrillo and Galo (Day 1988:142). Paulsen (1977) compared similarities of Carrillo Polychrome to some polychromes of Ecuador's Guangala Phase and Viel has noted Galo polychrome has stylistic similarities with maya ceramics of the same period (Day 1988:143). Both Carrillo and Galo are considered to reflect Mayoid influence (Accola 1978:67).

Carrillo Polychrome may have been the first true polychrome to appear in Nicoya for it is found in burials associated with Zoned Bichrome period ceramics dating to before 500 A.D. This is based on the abstract geometric decorative elements which, according to Lathrap (1977), continued a long tradition of symbolic representations of the caiman or alligator, an ancient god in Costa Rica and South America. These decorative elements are found in ceramics, stonework, and metallurgy.

Galo Polychrome is the best known pan-regional type seen as having a mixture of southern and northern decorative elements (Lange et al 1980:202). With Galo Polychrome began the arrival of Mesoamerican iconography in the form of the stylized jaguar with bifurcated tongue and skin adorned with "rosettas" (Day 1988:144). At some time the abstract symbol of the older caiman appeared in Guanacaste, mixing with the more recent jaguar icon to create a symbolic representation similar to a dragon, but this was quickly replaced in the area by the motifs of Maya origin found in the Galo Polychrome ceramics (Day 1988:144).

Galo and Carrillo disappear near the end of the Early Polychrome Period but related types such as Mora continue the tradition of reflecting Maya iconography including the Kan cross, mat pattern, chevron, solar explosions, shaded areas, and an inclined figure with artistically worked feathers (Day 1988:145).

Carrillo Polychrome (Baudez 1967:117-121; Sweeney 1975).

Red and black lines on beige vessel, tripod dishes, and medium size opened neck ollas.

Nacascolo sample: Art.159, open necked bowl with geometric motif (Plate 64), associated with Burial 47, an adult, male. Art. 226, open neck bowl with geometric design,

very deteriorated. Effigy vessels: Art. 164, ray effigy (Plate 64), used to cap infant urn burial 49. Art.105, bird effigy (Plate 61 b), associated with Burial 33, adult, male?

Galo Polychrome: (Baudez 1967:130-133; Sweeney 1975; Healy 1980:120-124).

Same coloring as Carrillo but noted for glossy appearance and overall better quality.

Nacascolo sample: Art. 196a, fish effigy, Bothidae, associated with Burial 72, possibly a full term fetus.

One half of a Chavez Red on White vessel (Art.196b; Plate 65) was found inside the Galo vessel, also associated with a large beige ware sherd (Art.140). No other examples of this type in beach cemetery..

Chavez White on Red (Coe 1962:362; Norweb 1964:559)

Referred to as "Alhambra White on Red" by Lange (1971c) and as Urcuyo by Healy (1980). Characterized by red or maroon slip vessel with white designs usually geometric patterns, hanging lines, some in form of stylized animals.

Chronology: found at beginning of Early Polychrome Period. Lange considers this type a horizon marker for the period in Nicaragua at the northern limit of Guanacaste.

Nacascolo sample: One bowl (Art.196b; Plate 65) found with a Galo effigy vessel and associated an infant (Burial 72).

One effigy support (Art.13; Plate 66) from broken vessel, identified as an owl (Tytonidae).

Leon Punctate (Norweb 1962:559; Sweeney 1975:167-169; considered part of Rivas Red by Healy 1980:209-211). Red rimmed tripod grater bowls. Exterior surfaces including supports are always slipped red. The interior is burnished buff with red slipped or painted upper walls (about 1/3) of the distance from the rim to the center bottom. Form VI is a shallow rounded simple profile bowl with divergent walls, rim is unmodified, lips usually rounded or bevelled. Sweeney noted the bases or supports are solid, in types such as Juanilla Red on Buff and Los Hermanos Beige; they are hollow in Guinea Incised and Chavez White on red. The later phases possess bulbous mammiform supports which are the kind Norweb described for Rivas, and Healy notes as having a variety of pastes. The central punctations are slashes made with an awl type instrument in order to roughen the bottom interior supposedly for grating purposes. These are not necessarily placed in designs although some grater bowls from Nicoya do have incised designs.

Chronology: Late Las Minas Phase through the Matapalo phase in the Tamarindo area, equivalent to the Mata de Uva Phase in Culebra Bay (300-500 A.D.), appears slightly later in Santa Elena Phase into the Doscientos phase in

the Santa Elena peninsula (Sweeney 1975). Baudez did not find this type in Tempisque. DCC determined Leon Punctate to have northern emphasis (Lange et al 1984:210).

Comparisons and Reference: Norweb 1962; Sweeney: pl.25:c,g pl.24:c; Lothrop (1926):219 fig.111; 221 fig. 113.

Nacascolo sample: Associated with Burials 53, 55, 104, 105, 106, 107, 112, 113; all ages and both sexes. Art. 357 contained infant Burial 113. Found in context with other ceramics of Potosi Applique, Guinea Incised (Gutierrez and Negative Resist), Red ware, Juanilla, plain tripod metate and ellipsoidal mano of Burial 104.

Potosi Applique (Norweb 1962; Baudez 1967:171; Sweeney 1975:163 or 240; Healy 1980:104 or 194). Applique conical lumps on an unslipped vessel, usually an incense burner. Convex walled bowl with annular base and hemispherical lid. Referred to by Lothrop as "alligator ware;" often has modelled applique alligator on top of lid.

Chronological placement: Early Polychrome.

Nacascolo sample: Artifacts 209 and 210, annular base bowl and lid vessel, has modelled applique feline on lid (Plate 67). Associated with Burial 53, middle adult, male. Art.350 associated with Burial 104, middle adult, male?, and ceramics of Juanilla Red on Beige, Red ware negative resist, Leon Punctate, two pestles, ellipsoidal mano, plain tripod metate, and Ficus ventricosa shells.

Cabuyal Polychrome (Baudez 1967:145-147 pl.43:c-e; Sweeney 1975:237-239).

Characteristic motif found on the vessel neck consists of groups of horizontal wavy red lines framed between two horizontal black lines. Lip and vessel body is red.

Chronology: Appears at the end of the Murcielagos Phase through the Santa Elena and Matapalo phases of the Early Polychrome Period, continues through the Doscientos phase, appears in the Tamarindo phase, and finally ceases at the start of the La Cruz phase of the Late Polychrome period at Cahuite Escondido; equivalent to end of Mata de Uva through Culebra (300 A.D.-800A.D.).

References: Baudez found Cabuyal in his La Guinea assemblage where it occurred in the Palo Blanco phase of the Middle Polychrome period. It is an earlier manifestation in the Santa Elena peninsula than elsewhere in Guanacaste. Accola noted similarities between multiple brush lines on Cabuyal and Carrillo, which led him to believe Cabuyal a transitional type beginning in the Early Polychrome and lasting into the Middle Polychrome Period. A Cabuyal vessel was found in Early Polychrome mortuary contexts at Mojica (Accola 1978:89). Hoopes (1980:49) reports finding one vessel at La Guinea which exhibits design elements of both Carrillo and Cabuyal. One vessel with a mix of Cabuyal and Charco Black on Red design

elements is found associated with Burial 85. The classic black and red wavy lines on beige ring around the neck and a series of four black lines, horizontal and vertical, ring the upper vessel body below the neck (Plate 59).

Nacascolo sample: Artifact 32 (Plate 67), associated with Apompua Modelled vessel and Los Hermanos Beige vessel and Burial 6. Art.120, a bowl with eight adult teeth placed inside, associated with Burial 39, an adult, female; this burial's cranium was not found.

Middle Polychrome Period Ceramics

Middle Polychrome Period (800-1350 A.D. Lange et al 1984) ceramics mark an excellence in engraving, burnishing and modeling represented by the Huerta series, and Nicoya Polychromes were mass produced at this time and demonstrate proficiency in painting. Diagnostic color combinations appear: orange, red, and black on white slip (Papagayo series); orange and black on buff (Birmania). There is a marked distinction between the northern sector white-slip tradition and the southern sector tan-slip tradition of Greater Nicoya as represented by Mora Polychrome and its varieties and Papagayo Polychrome respectively (Lange et al 1980:203). The Nacascolo data reflect more northern traditions. Zoomorphic and anthropomorphic supports and adornos reach high

frequencies in Sweeney's data, hollow supports and dimple bases (Huerta series) are both diagnostic traits of the period. Geometric designs were supplemented by life themes such as those of Birmania and Mora. Composite silhouette tripod bowls and jars with incurved rims are distinctive. Late in the period pyriform jars become popular. Loop and strap handles are common to the plainwares, as well as zapateros, the so-called boot shape, and solid supports continue in Juanilla Red on Buff and Armas Red.

Huerta Incised (Sweeney 1975:304?).

No Huerta vessels are found in the beach cemetery but one representative sherd was found in one of the near surface sherd concentrations.

Mora Polychrome (Baudez 1967); Sweeney 1975:254; Accola 1978:62; Healy 1980:152). Six varieties. It is the contention of Baudez (1967:39) that there is no temporal significance to the six varieties of Mora.

Nacascolo sample: Artifact 35 appears to evidence all varieties on the single vessel (Plate 68 and Figure 6.3). Associated with Burial 9, possible extended burial of unknown age or sex. Art. 38, a spindle wheel (Plate 70), found near Burial 12, "few long bones left in wall," one Palmares sherd, and large beige ware vessel (Art.37).

Papagayo (Norweb 1964; Baudez 1967:142; Sweeney 1975:261; Accola 1978:72; Healy 1980:167). Geometric designs and stylized life figures in orange, red and delineated with black lines, on white slip. Serpiente variety decreed at DCC conference.

Nacascolo sample: Serpiente variety. Artifact 113, copon style with undulating figure on upper flange base (Plate 69 and Fig.6.4. Associated with Burial 36, adolescent, female?.

Late Polychrome Period Ceramics

Late Polychrome Period (1350-1550 A.D. Lange et al 1980:213). All the old plainwares die out and most ceramic types are new. Open simple bowls, incurved bowls, composite silhouette tripod, tripod necked jars, and pyriform vessels are most popular; usually handles are absent. Zoomorphic and anthropomorphic hollow tripods continue; many bowls are without supports. A new color, blue-gray appears, diagnostic of Vallejo Polychrome, which may also be incised through the slip. Mombacho Incised Polychrome is underslipped incised ware but otherwise similar. The wide grooving of Murrillo Applique is aligned with the modeled nodes and applied zoomorphs, also characteristic of the period.

Jicote Polychrome (Baudez 1967:161; Sweeney 1975:329; Accola 1978:68; Day 1984:289). A Luna ware. It is the contention of Haberland (1969) and others that Luna ware is of southern influence reminiscent of amazonian traditions. No vessels are associated with any beach cemetery burials however, 2/3 of one Jicote vessel was found in near surface sherd concentration of 8G (Feature 1). One other Luna ware sherd (possibly a human and feline mix effigy), was found in Feature 15, the fill that covered Burials 54 and 79 (Plate 73)..

Murrillo Applique (Baudez 1967:165; Lange:1971a,c: Sweeney 1975:352; Accola 1978:75; Creamer 1983:296; Day 1984:306). Murrillo Applique is indicative of outside intrusion (Lange 1976:51) and of southern influence (Lange 1976:39). No Murrillo vessels are associated with any burials in the beach cemetery. This type, both red and black, are associated with the ovens of Op.8K (Feature 13), and the burial fill overlying Burials 55 and 79 (Feature 15).

Ceramic Technology

Most of the early Nacascolo vessels have carbon cores indicating they were fired at +-600 degrees. Many vessels exhibit fire clouds indicative of uneven oven fire. Artifact 86, a gadrooned type vessel, was impressed while

in leather-hard state; the indentations were most likely made with forefinger and thumb. Sweeney noted one sherd of Monte Cristo Beige with red dribbled lines running down from the rim (Sweeney 1975:107) and several Nacascolo vessels exhibit similar streaks. Paint streaks such as these are often the result of applying paint before the vessel has dried completely. Norr (1986) likewise commented on the rather sloppy nature of the ceramics she examined. Similar dribbled lines, crude type vessels, even one with one horizontal and one vertical handle (Plate 50) demonstrate this. "...todas personas no puede hacerla ceramica policromo Nicoya" [not everyone can make the fine Nicoya Polychrome] (Sergio, personal communication). There are degrees of expertise among everyone and it takes time and practice to perfect the skill. The Nacascolo data demonstrate this. Shortcuts are also taken in the iconography on painted vessels. For example, the feet of the "swimming figure" depicted on the Papagayo vessel (Artifact 113) are the same as the hands. This figure and vessel shape are reminiscent of Copador Polychrome of Honduras (Beaudry, personal communication). The swimming figure is a highly stylized human figure (Beaudry 1983).

Additional Ceramic Artifacts

Spindle whorls (1)

One might imagine this artifact category would be well represented among a population with such a balanced male:female ratio, yet only one spindle whorl was found (Art.38; Plate 70). It is of Mora type, representative of the Middle Polychrome Period (Lange et al 1984).

Perforated sherds (1)

This kind of perforation differs from holes drilled into several whole vessels found throughout the cemetery; in the former holes may have been used to repair fractures in ceramic vessels, whereas in the latter, holes such as these are referred to as ritual "killing" of the vessel. Artifact 178, a Zelaya Trichrome tripod support vessel, associated with Burial 55, exhibits a finely drilled hole in the lower part of the bowl. A nearly identical hole is found in a Mora type vessel published by Baudez (1970). Artifact 326, associated with Burial 105, also exhibits vessel perforation however, it is larger than that of Art. 178, and it is less round.

Ceramic Cones (2)

This is the first description (Plate 71) of this type of artifact for it is the first example recovered

archaeologically; no ethnographic parallels have been found and much speculation has been advanced concerning their function. "Ritual drinking vessels" or "drums" were the first hypotheses proposed (Hardy 1983). The latter is not an unusual hypothesis considering drums are found from Chiriqui, Panama, to Honduras (Lothrop 1926 Vol.11:275). Leather hides were believed to have been stretched across the aperture similar to pottery drums found among Talamancan Indians (Stone 1958:38, Figure 10:c,d:48). Stone (1958:38) states that these drums were plentiful in the Nicoya region where they are associated with both monochrome and polychrome ceramics. She describes the typical form as "upright and cylindrical, usually with a pinched waist." Stone suggests one end was covered with hide, probably iguana, such as is used today in Talamanca and Guatuso and played with the fingers. She does not indicate if these are closed or open on the bottom.

The closest resemblance to the Nacascolo cones I find is from Postclassic Quelpa zone of El Salvador (Longyear III 1966:figure 12:q); however, there is no indication if the two ceramics (or stone?) pictured are open or closed ended. They also differ in that the El Salvador objects have anthropomorphised appliques.

Hoopes uses the open-ended-closed criterion for his

interpretation of drums vs. vessel explaining that a drum would not resonate with a closed end (personal communication). He suggests that the cones shape would naturally filter any liquid with resulting sediment sinking to the bottom. An interesting aspect of the cones is the deteriorated state of the pottery. The other ceramic vessels found in association with the cones do not exhibit similar deterioration. Differential preservation has been noted within the same burial in this cemetery but this does not appear to have been the case here for only these cones are affected. The rest of the associated grave offerings including ceramics, and the skeleton, exhibit similar preservation. This suggests that what was placed inside the vessel possibly had corrosive qualities.

Oviedo discusses two beverages of great importance among the Nicaraos and Chorotegas, chicha (corn beer) and cacao (Theobroma cacao). Both beverages are potentially corrosive and noted for their use in special social functions. Chicha, an intoxicating fermented corn beer, was noted for its ceremonial use, particularly in mortuary contexts and ceremonies involving human sacrifice, and was the source of inebriation so pronounced among the Chorotegas and Nicaraos in historic times. Chicha is considered more characteristic of the Circum-Caribbean groups than Mesoamerica (Steward 1948:6).

Cacao (Theobroma cacao) was an extremely important commercial crop whose production was monopolized by the Nicarao. Cacao beans were used as money and tribute. The beverage made from cacao beans was noted for its medicinal qualities (Oviedo 1976:68), reserved for elites, and associated with people who drink human blood (Oviedo 1976:70).

This chocolate drink was not the sweetened beverage most of us enjoy today but was often flavored with chili resulting in a bitter taste. Oviedo (1976:71-75) described cacao preparation among the Nicarao and a process which included drying the beans in the sun, roasting, then grinding the beans on metates four or five times, adding a little water each time to make a paste which was then formed into cakes. To make the beverage, a little cacao paste was mixed with water in a gourd and achiote was added which made the drink look like blood. Before drinking, the beverage was poured from one gourd to another in order to create a froth on the surface. Those who drank cacao would exhibit the bloodlike mixture on their face and apparently did their best to achieve this effect while drinking (Oviedo 1976:70).

The uniqueness of the pottery cones suggests

possession was limited to some sort of specialist for use in important functions. The deteriorated condition of the pottery suggests their use with corrosive elements such as cacao or chicha. The fact that two cones were found supports the interpretation for their use with cacao for they could have been used to pass the beverage from cone to cone. And finally, the restricted access of cacao to elites, and the bloodlike quality of cacao would reinforce religious beliefs held by elites concerning blood and human sacrifice, as well as serving to further differentiate elites from commoners.

These cones were associated with Burial 31, an old adult, male; he was also distinguished by a tool kit that included worked Strombus columellas, a "killed" Lyropecten subnudosis, three chert hammerstones, and a bone awl, (Plate 72). One Tola and one gadrooned monochrome vessel, date this individual to the end of the Zoned Bichrome Period.

Stone Artifact Assemblage

General stone artifact categories consist of metates, manos, celts, pestles, hammerstones, nut crackers, unworked stone and stones with enigmatic qualities, one jade bead and one jade pendant. No cross-

sections of the jade (greenstone) objects have been analyzed, but they have been identified as jade by geologist Cesar Laura of MNCR. Representative stone artifacts may be found in Plate 73.

Stone tool morphology indicates multi-functional stone artifacts. Secondary uses were found for broken tools, or tools were reworked/reused as need arose. Hammerstones may have been used as manos or a mano used on end as a hammerstone or pestle. We know that metate legs were reworked and used as manos, pestles, and/or hammerstones. This is graphically demonstrated in the Nacasclo beach cemetery stone artifact assemblage, for example, Artifact 114 exhibits wear patterns on five surfaces (Plate 73).

Metates (5)

Both plain slab-leg tripod and the more elaborate low relief tripod, with double-headed bird projections, are found in the beach cemetery (Plates 74, 75). Four of the former and one of the latter have been excavated. One low relief carved metate (Art.109) was with Burial 34, mid-adult female, no mano associated. A similar metate was found in the cist tomb of Op.3a and this one was associated with an overhang mano; comparison of the two low relief metates may be seen in Plates 75 and 76. A

nearly identical metate from Las Huacas may be seen in Hartman (1907:Plate), and one (with incised mano) has been reported from looted contexts at Monte del Barco (Accola and Ryder 1980:74-75). The four plain tripod metates found in the beach cemetery all evidence wear on the grinding surface. Three of them were associated with ellipsoidal manos (Plate 73: Arts 170,44,339; Plate 74). The only plain tripod metate not found with a mano was Art.109, associated with Burial 34.

Plain metates such as these, cut across age and sex divisions. They are found associated with an adult, female (Burial 34); old adult, male (Burial 104); and a number of infants in Op.8F. This last metate has a single protrusion on the forward end (Plate 74). At La Ceiba, the metates were found only in association with women, except one elaborately carved metate which was not accompanied by a mano (Juan Vicente G. personal communication). Contrary to Snarskis (1981) only one of the elaborate, low relief carved metates found at Nacascolo in mortuary contexts is associated with a mano: the one associated with beach burial 34, a female, lacks a mano. The confusion may have arisen from the fact that an ellipsoidal mano was associated with this burial, but it was placed next to a plain tripod metate and several vessels in the burial pit fill, whereas the incised metate

and another plain tripod metate were placed directly over the body of the deceased. The individual buried in the cist tomb is accompanied by a similar incised metate and overhang mano. Stone (#1439:3) describes a slab-leg tripod metate with a single "macaw head" projection among the many grave offerings associated with an elite burial at Las Palmas, Nacascolo.

The incised special purpose metates are representative of what has been referred to as the first true traditions of stone sculpture in Costa Rica, appearing in Nicoya and the Atlantic watershed around A.D. 1-500 (Graham 1981:113). The plain tripod metate appears somewhat earlier in Nicoya 300 B.C.- 300 A.D., apparently a selective local adoption of a highland Mesoamerican ritual-mortuary trait.

Theories concerning the metates function (e.g. grinding stone vs. seat) as discussed in Chapter 1, has long been a source of debate among Intermediate Area archaeologists. Ryder (1983) has provided the most thorough compilation of archaeological evidence of metates as well as a literature review of this controversy. The metates functional interpretation and their symbolic significance is discussed in Chapter 6.

Manos

Manos are hand implements used in grinding activities on millingstones or metates. Since the mano assemblage consists of complete implements, the typology is based on longitudinal perimeter or silhouette of these shapes. These include ellipsoidal, loaf-shaped and round forms. One slightly overhang type has been found in the beach cemetery and one overhang mano was found in association with an incised metate found in the cist tomb of Op.3a.

Type 1: ellipsoidal (3; Plate 70)

Dimensions: length @ 34cm., 5.6 cm. wide.

Material: andesite.

Artifact 170 has a tapered groove down the center of one side and both sides exhibit wear. It was found in the area of infants (Burials (51, 52 etc.) and associated with plain metate, tubular jade bead, and ceramics (Plate 22). Artifact 339 exhibits wear on only one side and was associated with a Male?, 45-50yrs. (Burial 104; Plate 18). The third ellipsoidal mano (Artifact 44, Feature 1, Burial 34) has a slight overhang and both sides exhibit wear, it is associated with a plain tripod metate, and is part of the burial fill grave offerings of Burial 34, a middle-adult, female.

In the beach cemetery ellipsoidal type manos are

always found in association with a plain tripod metate. This duo is found in association with infants and male and female adults. Ellipsoidal manos are all found in terminal Zoned Bichrome and Early Polychrome Period contexts. During the Middle Polychrome period river cobble or loaf-shaped manos were used.

Type 2: Loaf shape (Plate 70, Art.136)

Material: andesite.

Art.136 found in 8G, not directly associated with burials but may be related to Feature 10. River cobble type grinding implements associated with Middle Polychrome Period contexts.

Type 3: Round but usually has oval cross-section (Plate 70, Arts.66,132).

Material: tuft, andesite, basalt.

Art.66 (basalt) associated with Burial 22 and a stone celt (Art.71); this individual, a young adult, of undetermined sex, dates to the Middle Polychrome Period. Art.132 (tuft) associated with Burial 71, an older adult, male, of the Early Polychrome period. The relatively soft nature of this round tool possibly precludes its use as a "mano." This functional designation is based on shape and wear patterns exhibited on both sides and edges; it may not have been used on metates but used in some other activity.

Celts (hacha) 5 in cemetery (Plate 77): a class of polished axe-like implements of trapezoidal or petaloide form, approximate oval cross-section, which are said to be descriptive of the form but not necessarily of function (Bernstein 1980). Celts" are believed to have been land-clearing or boat making. Based on morphology and microscopic characteristics, Bernstein (1980;1984) has proposed at least five functions for Guanacaste "celts:" hacha, azuela, intermediate tool, percutores, and moledores. I follow his type nomenclature. "

Material: andesite, basalt.

Art.204, andesite, (Plate 70, 76d) a "waisted" celt: lateral indentations at approximate mid-tool (where it was hafted?) which give the tool a waist look (Bernstein 1980:143 Fig.1). This artifact not directly associated with any burial. Art.360 (basalt) associated with Burial 111, a middle adult, male, is flat on the bottom. A similar "black stone polished celt" was reported in the combination burial of Wallace and Accola (1980:55, 59 Fig.5B). One associated with Burial 34 has a blunt end from pounding. Art.367h, is planned on both sides.

Of the five "celts" only two are associated with burials: 1) 8C 40-60 (in tomb fill of Burial 34, Plate 77e) and 2) Art.360 associated with Burial 111, a middle

adult, male. Art. 135 (Plate 77 c) was associated with Ft.10. The others (Art.204 and 8A 0-20, Plate 77a,d) were found in level bags and lack specific associations. Bearing this in mind, with the exception of the celt's association with Burial 34, an adult female, this type of tool appears to be male oriented. Its location in 34's burial pit is in proximity to the metate, mano, and ceramic vessels of Feature 1 (Arts.38-45)-which were placed in the burial fill. It is possible the celt's association with this woman was more an expression of subsistence related agricultural practices than for inclusion as a female object.

Pestles: type 1 (Plate 70), small (2)

Pestles, like manos, are tools used for grinding or pulverizing materials. This tool has a rounded tapered handle and usually broadens at the butt end. The butt is sometimes rounded and flattens with use. This type of pestle was found in the same burial (Burial 104). Both are andesite, with rounded cross sections, but their shapes differ somewhat; Artifact 363 broadens at the base end and Artifact 362 tapers at both ends and is more tubular. Both pestles exhibit wear at the base end. Artifact 362 was placed inside a Ficus ventricosa shell (Plate 84).

Pestle: type 2, large (2); Plate 78 b,c.

Material: andesite

Rounded cross-section. One exhibits indentation on one lateral surface due to hammering, might conceivably be called pestle/hammerstone.

Pestle: type 3, cigar shaped (2); Plate 78 a,b.

Material: andesite.

This type of pestle is cigar-shaped with rounded cross section and tapered ends. Sometimes both ends exhibit wear patterns suggestive of grinding and/or battering. This tool has been mistakenly referred to as a mano, functional designation should be pestle/hammerstone. The tool could have been held in two hands, or hafted and used in agricultural activities. This type of stone tool has not been found in association with metates and appears to be restricted to adult males. Of the six pestle/hammerstones excavated three are definitely associated with adult male burials (Burial 54 Artifacts 202 and 203; Burial 82 Artifact 284), one with a possible male (Burial 71 Artifact 132, tuft), one isolated pestle (Artifact 201 8H,150cm.) which may be part of burial fill of an unexcavated burial, and one (Artifact 233 8G unit 2) with unknown associations. This tool is found in Middle Polychrome Period contexts. Mason describes this type of tool for southern Costa Rica; he did not speculate on the function but noted probable misnomer as mano.

Two tools of this type were associated with Burial 54, an adolescent male, two Strombus flanges, a Strombus drill, stone "mojon," and two small stones placed below the pelvis (Plate 80 d,e).

Hammerstones: (11) Plate 79.

Material: chert, andesite.

Three associated with Burial 31, an old adult male, and eight placed inside a Guinea vessel (Art.224) with unidentified iconographic element (Plate 63), associated with Burial 57, a middle adult, female. Both burials date to late Zoned Bichrome-Early Polychrome Period.

Abraders (2) Plate 80.

Material: sandstone.

These are small, narrow, bar-like implements with sides and edges evidencing wear striations. They were possibly used on chisels, adzes and small celts. Described as "whetstones" by Ranere and Rosenthal (1980:482) and pictured as "rasps" by Einhaus (1980:460 Figure 15/13 e-h). Einhaus's whetstones (1980:460 a) are harder greenstone.

Comparison: A nearly identical stone from Chiapa de Corzo pictured in Lee (1962:Figure 87:e) and from Panama (Ranere and Rosenthal 1980:483 Figure 16/5 b and c; and Einhaus 1980:460 Figure 15/13 e-h).

Nacascolo sample: One (Art.94) associated with Burial 11, a middle adult, female?, and another one (Art.95) found in the tomb fill of Burial 34, a high status, middle adult, female of Early Polychrome Period.

Small stones: both unworked stones and those exhibiting evidence of wear are found. They are made of pumice, tuff, and other materials, and are noteworthy for their deliberate placement on burials. They are found on top of the chest, between the legs, and in one case, under each side of the pelvis of Burial 54 (Plate 81 d,e). Some stones similar to these found around Culebra Bay have been referred to as "polishing stones;" and some bear central indentations suggestive of "nutting stones." Some of these probably served these functions, however, considering the deliberate placement of some of these stones under the pelvis, or on top of the chest it is likely some of these stones had medicinal or magical qualities. Haberland (1976:115) mentions encountering divination rocks in tombs from Buenos Aires in southern Costa Rica dating to the Burica Phase (600-800 A.D.).

Another interesting stone tool bears description (Art.126; Plate 80). It is small, roughly rectangular (4cm. X 3.5cm., and has an indentation in the central area on one surface (like a nutting stone), and white paint

covers an indentation on the top surface. The paint does not react to hydrogen peroxide. No archaeological or ethnographic parallels have been found. It may have been used as a palate, similar to that described for a fossilized shell (Art.305, Plate 85).

To summarize the stone tool assemblage, if one eliminates the prestigious mano and metate associated in the area of infants, no stone tools have been found associated with infants or children. One jade (greenstone) tubular bead was associated with these infants (Pl.82). At age 17-19, we find one adolescent associated with a type of nut cracker "rompe nueces." Vicente and Blanco (1986) have commented on an apparent relation between male burials and lithic tools at La Ceiba. They suggest that stone tools, particularly metates and manos, may be used for identification of sex in cases where skeletal remains have not been preserved or their identification is inconclusive. Only one elaborate incised metate has been recovered from La Ceiba, and that associated with a male burial (Guerrero, personal communication). No such incised metates are found with females at La Ceiba but females are associated with plain tripod metates. This distinction differs from manos and metates found among burials at Nacascolo. At Nacascolo, Plain tripod metates are associated with infants (51 and

52), a middle adult, female (34), and one old, male (104). The female (34) was associated with two plain tripod metates (Arts. 44 and 109) one of which was accompanied by a ellipsoidal mano (Art.45). She was also provided an elaborate incised metate with bird-head projections (Art.110) which was not associated with a mano.

Shell Artifacts

The shell artifact assemblage, representing 16% of grave offerings in the beach cemetery, is not particularly elaborate. Parts of the conch Strombus galeatus were most often used, particularly the outer flange (Plate 83) and inner columella. Hobbs and Roden (1964) suggest the flange tool was used as a hoe. The beach cemetery samples could have been used to dig the grave of the interred individual. They certainly could have easily dug the beach cemetery sand. Another object derived from the conch Strombus galeatus, but utilizing the inner columella, is a gouge or chisel (Plates 72 and 83). This type of tool was first described as "peculiar" (Coe 1962:362), from Coe's excavations in Cahuite Escondido shellmounds. Coe dates these to the Middle Polychrome Period. Sweeney (1975: Pl.86 D-J) shows a photograph of these objects from the Coe's Cahuite Escondido assemblage, (Sweeney 1975: P.619 C). The

examples from the beach cemetery are found with late Zoned Bichrome-Early Polychrome and Middle Polychrome burials. The well worked chisels associated with Burial 31 (Arts.92e-r) suggest the tools of an unknown kind of craft specialist, the type specialist is uncertain. They could have been used in ceramic production, skin work, wood working, or some other activity. It is interesting to note their association with the rather enigmatic ceramic cones of Burial 31.

Of 17 Strombus galeatus flange tools found in the beach cemetery, 15 were directly associated with burials and 2 were not. Fourteen of these are associated with adult males or possible males (M?), one associated with an adolescent male, and two associated with a female (Burial 55). They are found with individuals placed in all variations of flexed burial position, as well as individuals extended on stomach and back.

With the one exception noted above, the chisels/drills are apparently male oriented. This type of tool has been found in other Nacascolo excavations.

In Guangala culture, Strombus tools similar to these, are referred to as drills (Bushnell 1951:Fig 24K). They also form part of the shell tool assemblages of Panama and

Columbia and Venezuela.

Several slightly modified Ficus shells (Plate 84) were found in the beach cemetery, and associated with an old adult, male (Burial 104). One was found inside a vessel associated with Burial. Modified Ficus shells are also found in Guangala culture from La Libertad site and are described as spoons (Bushnell 1951:Fig 24 j). They were made by cutting a gastropod shell Ficus sp. in half, and removing the columella (Bushnell 1951:60).

Lyropecten subnudosis shells, with or without central hole, are associated with several burials (31, 85, 104 and Feature 13). They are also male oriented, beginning in late Zoned Bichrome times; their use apparently continued through Late Polychrome. One, without central hole, was found on the surface of Feature 13 of Op.8K, another with Burial 31. The central hole may symbolize the ritual "killing" of the offering.

Worked Ostrea (2)

Two Ostrea shell artifacts with central holes have been found in the Nacascolo beach cemetery but they cannot be associated with a particular burial (Plate 84). The well-worked and smoothed central holes differ from holes found in Lyropecten subnudosis mentioned previously, which

suggest they were suspended from something and not ritually killed (compare with Plate 72). They may have been used as decorations and hung from a house, pole, or perhaps, even worn around the neck.

Fossilized shell (1)

One roundish, somewhat enigmatic fossilized shell with central indentation was found with Burial 85 (Plate 85). Aesthetically pleasing, it fits in the palm of a hand and may have been used as a snuff palate. It was found in association with Burial 85, an adult male that dates to the terminal Early Polychrome Period-Middle Polychrome Period. Compare this to Art.126, Plate 80.

Shell Scraper (1)

This tool is remarkable in light of the complete lack of any points, blades or scrapers which one would identify as cutting tools in the beach cemetery. Found in association with Feature 18 (Plate 85).

Coral beads

Found with three individuals: one adult female (Burial 11), one infant (Burial 107), and the grave offerings associated with unexcavated burial 8F (Plate 82). The infant was associated with a Tola vessel dating this burial to the end of the Zoned Bichrome-Early Polychrome

Period. I would expect to find more coral and shell beads on individuals in the cemetery but they are not common.

Other worked shell artifacts include several spire-lopped Olivella beads were associated with burials 4, 69, 13a,b, 102. One worked but unidentifiable shell has a sharp point and was found with Feature 18 (Plate 85).

Unmodified shells were also provided as grave offerings including anadara and trachycardium.

Bone Artifacts

Bone artifacts represent only 2% of grave offerings associated with the Nacascolo beach cemetery.

Awl (1) Plates 72, 88 :

One bone awl (Art.92a) made from left metatarsal of young deer (Gutierrez, personal communication). This was associated with Burial 31, an old adult, male, and grave offerings of Strombus, Lyropecten, chert hammerstone tools, and Tola and monochrome vessels; burial dates to the end of the Zoned Bichrome-Early Polychrome Period.

Needles or pendants (3):

Thin tapered bone artifacts, two have lateral incisions, one has a concave area suggesting the eye of a needle.

Similar bone artifacts have been found at Nacascolo (Lawrence, personal communication). At La Ceiba they are found in association with females (Guerrero, personal communication). It is also possible that they are pendants which could have been worn around the neck or sewn to clothes. They are also somewhat similar to hair pins used among California Indians.

Bone tubes (2):

Two modified human bones (Plate 86) were found stuck together by the calcareous concretions. When these were removed the tubes easily separated and were more thoroughly examined. Their size indicates they are modified from two human femora. They are undecorated, do not have holes which would suggest their use as whistles or a size difference to suggest pan pipes. They were found with Burial 68, an adolescent, male, who also was associated with turtle (Testudinata) bone.

Comparison of the bone tubes to archaeological collections and published photos of bone artifacts does not allow easy identification or functional interpretation. Stone (1967) has published photos of several incised bone and antler tubes reportedly from the Nacascolo site but they are not comparable in form or decoration. The Nacascolo tubes more closely resemble

bone tubes from Ecuador which are used for ingesting tobacco and other snuffs including hallucinogens (Reichel-Dolmatoff 1975). They may also be some sort of aspirator used by shaman specialists to suck out diseased objects from infirm individuals.

Bone beads (2)

One shark vertebra (cf. Careharhinidae) was found on the neck of Burial 44, a young adult, male (Plate 86).

Another worked bone (Art.315), a possible bead, was found with Burial 94, an adult, female.

Chapter 6

COMPARISONS AND CONCLUSIONS

Figure 6.1 lists the types of mortuary behavior encountered at Nacascolo and mortuary data recorded at sites throughout Greater Nicoya. The following discussion emphasizes these data and their comparisons to areas outside the region.

Nacascolo Mortuary Behavior

Nacascolo mortuary evidence from cemeteries located on the beach, valley, hillsides, and hilltops, indicate differential mortuary treatment. These different burial areas are the result of status distinctions, change over time, perhaps manner of death or some other factor which dictated their terms of interment. Differential burial practices were established from very early times and continued until site abandonment before the arrival of the Spanish (ca. 1522).

The earliest burials are found in the beach cemetery (Op.8A-M) located on the sand spit between the ocean and a mangrove swamp. Radiocarbon dates and artifactual evidence indicate the Nacascolo beach cemetery was in use by mid Loma B Phase of the Zoned Bichrome Period,

continuing through the Early, Middle and into Late Polychrome Periods (800-410 B.C.- A.D. 1283-1414); the majority of burial activities occur during the Mata de Uva Phase of the Zoned Bichrome, and Early Polychrome Periods. There is change indicated through the long tradition of burial practices and is seen in body treatment, burial location, burial fill, and artifact assemblages. The most obvious change in burial practice is in body position; the flexed position was used in early times, beginning in the Zoned Bichrome Period (B.C.600 - 500 A.D.), and was later replaced by the extended position. This is based on two observations: (1) the presence of earlier ceramic types associated with flexed burials, the extended burials associated with later ceramic types and (2) the tendency for burials intrusive to flexed burials, to be extended (Burials 3 and 4, and 9 and 11). There is not a single case of a flexed burial intrusive to an extended burial. While there is likely some temporal overlap between the two burial positions, the extended burial position is well established by the Middle Polychrome Period (700 A.D.).

The change in burial position, from flexed to extended, along with fine Nicoya polychrome ceramics, and an increase in shell and stone tools, the Middle Polychrome burial style; at this time burials may have much finer ceramics, but they also have fewer associated

grave offerings, at least in the beach cemetery. There is also more evidence of mortuary practices in other areas of Nacascolo at this time; burials are found in the valley area, under housefloors, and in shell mounds.

In the Late Polychrome Period (1200-1550 A.D.) burials are located in mountain top sites and flat areas of the high hillsides around Nacascolo such as Cascabel and El Chaperno. In these areas topsoil is shallow and burial pits are excavated into bedrock.

While these different burial areas throughout Nacascolo reflect only these particular periods and mortuary practices, mortuary evidence indicates the beach cemetery was used continuously throughout the entire occupation of the site from Zoned Bichrome to Late Polychrome Periods, the most intensive use occurring during the end of the Zoned Bichrome and Early Polychrome Periods.

Zoned Bichrome and Early Polychrome Period mortuary practices in the beach cemetery are essentially the same, consisting of primary individuals placed in flexed position, or variation thereof, in pits, and provided grave offerings, usually ceramics; some pits were covered with rocks to protect the grave. The difference between

Zoned Bichrome and Early Polychrome burial practices is one of degree of expression; the latter ones are more complex, in that they are provided more grave offerings and more variety. By the end of the Zoned Bichrome period there is evidence for shell offerings in burials. The shell assemblage becomes more elaborate during the Early Polychrome and Middle Polychrome periods. There is strong evidence to support food having been placed in vessels, however specific identification is unavailable at this time. In general, there is more variation among burials, indicating attempts to signal status or differentiate individuals. This is evidenced in the apparent, possibly restricted semiflexed and seated burial positions, and burial locations outside the beach cemetery, become apparent in the Early Polychrome Period times (500-700 A.D.). Whether or not burial areas other than the beach cemetery were used in Zoned Bichrome times is not apparent from archaeological evidence; this may however, be due to sample bias.

Further evidence of Early Polychrome Period (500-700 A.D.) burial practices is found along the northern hillside, and near the "Las Palmas" estuary, on the ocean side of Nacascolo (Stone #1430). As mentioned in Chapter 2, there are conflicting facts as to the location of La Palmas. In the former, individuals were interred in cist

tombs (Op.3a,b), which were then covered with stone mounds (Plate 5); these mounds are unobservable today from ground surface. This labor intensive practice precludes this type of treatment for the average individual, and was most likely reserved for high status individuals. The change in burial location is distinguishing change in size and type of burial structure. This perhaps reflects a changing attitude from an emphasis on the immediate family, to one of more group oriented behavior. Inside the cist tomb a low- relief, carved, "special purpose" metate with double, bird-head projections, an overhang mano, two Chavez White on Red vessels and two Galo Polychrome vessels, date the cist tomb to the Early Polychrome Period (500-800 A.D). No osseous remains were found with the exception of a few dental fragments in the western end, where it is likely the head rested, the body placed in extended position, overlooking the bay. A dark soil indicative of decay, was noticed roughly mid torso, extending through the head area and beyond an hypothesized anatomical area. The number of individuals, orientation, placement, age, and sex of the occupant(s) are forever unknown.

At Las Palmas, Stone described the grave offerings derived from a private excavation; no skeletal or burial analysis is available but the burial pit was reportedly 4-

6 meters deep. Among the grave offerings was a skull necklace made of carved shell (Stone, personal communication). Associated ceramics are representative of Early Polychrome Period. There may have been cut, basalt grave markers at the four corners. Stone (1977:69) mentions "stone columns mark grave corners, especially at Nacascolo" but it is uncertain whether she is speaking of this particular burial or in more general terms. If she is referring to Nacascolo, the grave markers were more likely ignimbrite and not basalt; ignimbrites are available locally and basalt is not available locally. At Bagaces, Lothrop reports, tombs (1926:91) are distinguished by four stone columns on the corners; this corresponds to a type of tomb one finds in Chiriqui.

Eight additional burials have been scientifically excavated throughout the Nacascolo site. Cultural contexts and associations date them to the Monte del Barco phase of Middle Polychrome (1000-1200) and transitional Iguanita phase (1200-1350). Some of the burials, dating to 800-1000 A.D., were associated with shell and sherd concentrations (Op.26, Vazquez 1986).

Any additional Zoned Bichrome and Early Polychrome mortuary practices from areas outside the ones already mentioned are unknown. We do not know if burial under

house floors was practiced before the Middle Polychrome Period, for no house structures dating to the earliest periods have been excavated. Only habitation areas dating to the end of the Early and Middle Polychrome Periods have been excavated (Vazquez 1986; Plate 6). The MNCR excavations stopped at approximately 270 cm. and did not reach sterile. The earliest and only evidence of site occupation corresponding to the Loma B Phase of the Zoned Bichrome Period (approximately 800 B.C.- 300 B.C.), rests on 8 Bocana Incised sherds found 90-100 cm. below the surface of OP.24 (Vazquez 1986:78). Where are the habitation areas of the earlier people whose remains are found in the beach cemetery? It is difficult to believe there aren't deeper occupations. Surely their habitation and occupational areas remain to be found. It is likely, the older occupations are underneath meters of alluvium.

With Boscana's demonstrated presence at Nacascolo, it is unusual that no burials have been found with this ceramic type, or with the temporally associated Rosales Zoned Engraved; this being one of the quadripartite "Zoned Bichrome death complex" symbols of elite authority proposed for Guanacaste/Nicoya (Lange 1984; Snarskis 1984; Tillett 1989).

Zoned Bichrome period mortuary practices detected

here and at other sites within the region, testify to local autonomy and regional diversity against a common formative background. These were already stratified societies, with elites, seeking ways to further demonstrate their position and power. To a large degree mortuary practices are constrained by environmental factors. If burials are found on steep hillsides they will more likely be laterally oriented. Stone mounds or cist tombs, may be reopened, allowing deposition of additional bodies. It is possible the stones comprising the tomb were removed to allow deposition of additional bodies; Perhaps this was easier than digging holes in the hard soil with stone and shell tools. Lajas are used where available, just as cut ignimbrite mojones, and river cobbles; cist tombs regardless of structural differences, are but variations of a similar theme. All require a certain degree of expertise and social cooperation in procurement of materials and structure construction; all such activity would be a focus of communal activity whose ritual express religious beliefs, and serves to reinforce alliances.

On the other hand, recent excavations by archaeologists of the MNCR at Canas, suggests a stone mound was constructed, over a Zoned Bichrome cemetery, in a single episode. This is the site of Reinaldo,

originally recorded by Phinney and Miller. Aside from the mound, this cemetery is similar to the beach cemetery at Nacascolo. Although few individuals have been recovered, infants, adults, males, and females, are found both with and without grave offerings (Philippe, Vazquez, personal communication). They are predominantly in flexed position, although one individual, without grave offerings was encountered in an extended position. The individuals with the most grave offerings has 14 vessels, jade pendants, and a stone figure. Many of the burials were associated with egg-shaped stones (Philippe, personal communication). The functional and material identification of these stones is currently underway.

This person would be one of the few at the highest level of the hypothesized hierarchy proposed for Nacascolo.

Moving further inland to the Guanacaste/San Carlos corridor, stone burial mounds become a focal point of communal activity. These mounds vary in size and tomb substructure, indicating individual and group burials, and are often found without skeletal remains due to poor preservation and/or disturbance. Stone filled mounds are reported for Hacienda Mojica (Ryder 1986), Hacienda Jerico (Finch 1984), Guayabo de Bagaces (Ryder 1986), Silencio

near Arenal (Bradley 1986; Mueller 1986), and Rio Naranjo (Norr 1986). All of these inland sites date to Zoned Bichrome and some Early Polychrome Period occupations. While the tombs are considered cist tombs, they differ from the cist tombs of more coastal areas in that the stones used for tomb construction (lajas) are flat basalt or andesite pieces, distinct from columnar mojones. As one moves away from Guanacaste/Nicoya, closer to the Central Valley and Atlantic watershed regions, cist tombs are made of laja and/or river cobbles respectively. Compare Nacascolo cist tomb (Plate 5) to those of Guayabo de Turialba and Aguacaliente (Plates 88 and 90). Those of the Atlantic watershed date to Zoned Bichrome and Early Polychrome periods whereas those of Central Valley at Cartago date to Middle Polychrome Period. Some may have been lined with wood or had wood roofs which perished long ago.

To what degree the variation reflects temporal distinctions, socio-cultural differences, or geographical differences, is one of the problems I have tried to resolve. It is obvious that analysis of one kind of mortuary practice, without regard to additional mortuary behavior, is inconclusive, inaccurate, and confusing. A single method of analysis is insufficient for multiple burial practices separated temporally and spatially, but

it may at least illuminate differentiation and change.

Middle Polychrome period mortuary practices at Nacascolo and other sites within and outside Culebra Bay are characteristic of the general times around 800 A.D. consisting of inarticulated remains, principally heads and long bones, associated with a primary individual in the extended position, known as "combination burial" (Ubelaker 1978).

Combination Burials and Cultural Practices

The earliest evidence for the deliberate placement of secondary remains with a primary individual is found in the Nacascolo beach cemetery among Group Burial 2 (Plate 23a). It consists of a disarticulated cranium (Burial 58) placed against the left occipital of Burial 57. The burial dates to the Orso Phase of the Zoned Bichrome Period (B.C.300 - 300 A.D.).

Wallace and Accola (1980a, 1980b) excavated a combination burial in the valley area of Nacascolo, dating to the Monte del Barco Phase of the Middle Polychrome Period (1000-1250 A.D.). The burial consisted of the primary remains of an extended individual accompanied by the secondary remains of 6 individuals (Plate 4). Crania

and mandibles were placed over the chest of the primary individual, post cranial bones, grouped by type and stacked on top of the long bones, were placed in orderly fashion along the right side of the primary individual (Wallace and Accola 1980:15). A modified portion of an adult right maxilla was discovered among the secondary remains. It has saw marks where it was separated from the rest of the maxilla; two perforations extend from the superior part of the maxilla through the palate, and were drilled with enough force to partially collapse the bone. A polished groove extends laterally across the superior aspect of the maxilla, connecting with one of the perforations (Wallace and Accola 1980:11). It is possible the primary individual was wearing this around his neck as a trophy head. The individual was associated with eleven ceramic vessels and a vessel support, a copper bell (Type d, Lothrop 1952:80), a polished celt, and a wafer thin piece of iron or manganese oxide, possibly from an oxidized mosaic mirror (Wallace and Accola 1980).

The demography of this group consists of two women, two men, one unsexed individual and one child accompanying the primary adult male. None of the secondary remains evidence decapitation, defleshing, or dismemberment of any kind. It is likely that this burial represents a form of ancestor worship; the secondary remains having been

disinterred from somewhere else for inclusion with the newly deceased primary individual in ways similar to that described for Talamancan Indians in Chapter 2. This graphically demonstrates an increasing practice of interring secondary remains with a primary individual.

In proximity to this combination burial, a second burial was found that was most likely disturbed during the interment of the aforementioned burial. This consists of the secondary remains of two adult males (20-30 yrs.) including two crania with articulated mandibles of two adult males (20-35 yrs.). One of the crania exhibits type A-1 dental filing (previously mentioned in the analysis of skeletal remains). Nothing concerning original body position, number of individuals, or grave offerings may be said about this burial due to the disturbance.

Turning to Late Polychrome Period mortuary behavior, at Cascabel, located on the northern hillside of Nacascolo, two separate bundles each contained the remains of two individuals (Lawrence 1981). One bundle contained grave offerings while the other did not. They were laid in preconceived order, the crania placed at either end of the tomb. The long bones were most represented in the skeletal remains, indicating preferential selection of specific bones, or perhaps represent what was left after

defleshing, however that may have occurred, whether by burial-disinterment-reburial, or by exposure to elements and then burial. Post holes dug into the bedrock were associated with the Cascabel secondary burials and may have been a scaffold or funerary hut. The entire tomb was capped with ceramics, both vessels and sherds (Lawrence 1981:19).

At El Chaperno, on the northern hilltop of Nacascolo, there is no structure, and the burials lack the grave offerings provided those at Cascabel (Lawrence 1981). Less order is given the secondary remains. Since both these sites date to the Late Polychrome Period, their demonstrated disparity in mortuary treatment of secondary remains possibly represents status differentiation (Lawrence 1981).

It is probable, but impossible to prove, that secondary remains accompanied a primary individual in the Early Polychrome period cist tomb of Nacascolo (Op.3a). At Papagayo, located within 5 km. north of Nacascolo, Baudez excavated a cist tomb of similar structure to that excavated in Nacascolo's north hillside. Skeletal preservation was much better however; secondary remains accompanied a primary extended individual (Baudez, personal communication). There was also an articulated

skeleton, in seated position, placed on top of the cist tomb; the entire structure was covered with stones. One accompanying grave offering contained fish vertebrae and two human molars. Although Baudez proposes a Middle Polychrome period date for the Papagayo cist tomb, he bases this on Middle Polychrome assessment of Piches Red and Cabuyal. The chronology for Piches Red and Cabuyal was discussed in Chapter 5. If one accepts the Early Polychrome-end of Early Polychrome period for these ceramic types (and Baudez saw nothing wrong with Early Polychrome placement for Piches Red in the Nacascolo beach cemetery); judging from these vessels in the Papagayo cist tomb, and the Chavez vessels in each cist tomb, the two cist tombs may be considered relatively contemporary. The number of grave offerings associated with the Papagayo cist tomb is not substantially different from Nacascolo 3A tomb. The 3a tomb, in fact, was provided the more elaborate and socially recognized powerful metate and mano. An additional difference between the two tombs is the social complexity demonstrated by the accompanying (sacrificed?) individual seated on top of the tomb. It would not have been unusual, to find a similar combination burial in the Nacascolo cist tomb had preservation been better. Like Nacascolo, at Papagayo, Baudez located three separate cemetery areas; one cemetery consists of primary individuals, one consists of secondary burials and lastly,

the cist tomb mentioned above.

The interment of primary individuals and accompanying secondary remains is well documented in burial practices throughout the region particularly around Culebra Bay, and Tempisque River Valley during the Middle Polychrome Period. Evidence for this practice is widespread throughout Mexico, Central and South America as well. Despite the plethora of archaeological data testifying to the extent and antiquity of combination burials, the reasons behind these expressions and associations remain speculative. Proposed interpretations include human sacrifice, either of the primary individual or secondary ones, or ancestor worship.

Wire (1972) suggests that primary individuals were sacrificed to accompany the secondary remains at the time of the secondary individual's interment. While there may be some validity to her hypothesis, I do not consider this to be the case in Greater Nicoya where the arrangement of secondary remains with respect to the primary individuals appear to accent and enhance the primary interment; the primary individual is the central focus, not the secondary remains. The care, style, and energy required in bundling burials, as opposed to mutilation and burial, suggest a social or familial tie of the primary individual to the

secondary remains. Older graves were often exhumed for reburial in a later grave of a prominent member of the family or lineage; this is evidenced in mortuary contexts of Nacascolo (Vazquez 1986), and may explain many of the isolated remains found in the beach cemetery as well. Combination burials have been reported from La Guinea (Baudez; Hoopes 1980), Vidor (Acton and Frankel 1979; Vazquez and Weaver 1980; Feature records), Papagayo (Baudez 1959, 1962; Day 1984:175-176), Bolson (Baudez 1960:2, 1967:38), Las Marias (Faulwell 1979), Las Huacas (Hartman 1903), Barrahonda (Minelli 1980), and La Ceiba (Guerrero and Blanco 1986; Blanco, Guerrero and Salgado 1989), and Isla Venado (Guerrero, personal communication), and Ometepe Island, Nicaragua (Bransford 1888; Fleischhacker 1972).

Whereas the secondary bundled burials demonstrate social ties to the dead, many of the semiarticulated and disarticulated remains provide evidence for human sacrifice and mutilation. Skull burials, articulated individuals with missing body parts, and groups of disarticulated remains have been reported from Nacascolo. Stone (1972:86) described what she believes evidence of mutilation in the severed lower legs of one individual from El Moral de San Blas. Faulwell (1970) reports a Late Polychrome burial at Las Marias composed of six skulls.

(Baudez; Hoopes 1980), Vidor (Acton and Frankel; Vazquez and Weaver 1980; Feature records of Vidor); Bolson (Baudez 1974)

Ethnohistoric sources for the Nicarao and Chorotega record human sacrifice and ritual cannibalism throughout the area at contact; and a trophy cult was also quite popular among Chibchan speakers. As discussed in Chapter 2, human sacrifice was prevalent throughout Mexico, Mesoamerica, lower Central America, and South America; archaeological evidence indicates the custom goes back to Formative times before the emergence of complex societies when these areas shared basic culture elements. The archaeological data presented here leave little doubt the Nacascolenos, and their neighbors, were actively engaged in human sacrifice, mutilation, procurement of trophy heads, and ancestor worship from early times.

The group burials of Nacascolo beach cemetery form a kind of spatial alignment unlike the burial formations encountered at other sites. At El Morote, Nicoya, Stone described nine burials in a circular formation, their heads pointed inwards towards a central figure (Stone 1977). Nor are these formations as large or complex as those described for Sitio Conte, Panama.

Mourning Ceremonies

Other mortuary practices include placing objects inside ceramic vessels or inside shells; objects found inside include human and non-human bone; smaller vessels inside larger vessels, rocks, and shells. Many of the vessels are burned on the outside or inside or both. In almost all Nacascolo cemetery areas, the beach cemetery, hillside cist tomb, and Middle and Late polychrome burials excavated throughout the valley and hilltop areas, adobe ovens and ritual burning comprise an important part of mortuary behavior. In what ways these were used and of what significance has been lost as there are no ethnographic reports detailing mortuary ceremonies which might explain the significance of ovens, cooking, or burning in mortuary ceremonies other than that detailed in Chapter 2. Some type of evidence of burning is reported in mortuary contexts from most sites in Guanacaste/Nicoya.

Mortuary Symbolism, Iconography, and Evidence of Subsistence Activities

One of the goals of this dissertation was to see how mortuary evidence might reflect subsistence activities.

The use of animals as food has already been discussed as part of animal ceremonialism. Symbolism associated with food is pervasive in most social groups and manifests ritual and iconography portrayed in artifacts (Wing and Brown 1979:14). Subsistence activities are accompanied, with rare exception, by magico-religion ritual of some sort (Wing and Brown 1979:13). These rites are attempts to ensure the safety of the hunter or fisherman and their success in bringing a good catch or harvest in light of so many uncertainties. These rites may include sacrifice or offerings, prescribed behavior, which includes abstentions, possession of amulets or good luck charms, and the culmination of these rites in a harvest celebration (Wing and Brown 1979:14). Deviation of the accepted ritual invites danger to the crop or resources and disaster to the community.

If this is so one should expect to find evidence indicative of agricultural practices such as stone implements - then a shift to marine symbolism and iconography. Manos, metates, celts and pestles are all tools supportive of agricultural activities. The nutting stones and hammerstones indicate precolumbian subsistence employed a degree of aboraculture; flora utilized, or food derived from plants would have been placed in ceramic vessels to accompany the deceased. Phytolith remains are

present in soil sampled from inside ceramic vessels but they have not been identified. These will shed light on the types of floral remains which were placed inside vessels to accompany the deceased. Floral and faunal evidence analyzed from vessels and ovens associated with the Middle Polychrome cemetery at the nearby La Ceiba site indicate an array of agricultural products including corn, beans (Phaseolus vulgaris), palm, avocado, and zapote; faunal remains found in vessels or in ovens associated with the burials include white tail deer, armadillo, guatusa, (Dasyprocta punctata); tepesquite, roedores, mapache and bats; fresh and salt water fish; reptiles birds and amphibians (Guerrero and Blanco 1987).

The use of ethnographic analogy for interpretation of Nacascolo iconography has its limitations. Symbols in all cultures have a variety of meanings, and it is a highly speculative interpretation of archaeological remains based on cultures separated temporally or spatially.

Decorated ceramic vessels and elaborate metates from funerary contexts, often depict rich mythology and inform about the religious beliefs systems of extinct peoples. This is especially beneficial in areas where writing was not practiced and no history exists except that contained in the archaeological record. The symbolism and ideas

represented by the iconography depicted on artifacts can transfer a basic utensil into a ritual object. The value of iconographic study in Middle and Late Polychrome period ceramics has been demonstrated by Day (1984); and in Costa Rican stonework by Graham (1981) and Ryder (1983).

Iconographic elements depicted on Nacascolo ceramic vessels reflect the temporal and stylistic distinctions mentioned by Day (1988) and are divided into two groups; the oldest group consists of modelled appliques and effigies of monochrome and bichrome wares, and the second group consists of iconography painted on polychrome ceramics. The later iconographic tradition reflects Mesoamerican iconography including the Kan cross, mat pattern, chevron, solar explosions, shaded figures, and an inclined figure with artistically worked feathers (Day 1988:145).

The first iconographic tradition, essentially naturalistic representations and geometric motifs, is found among Central and South American formative cultures.

Icons portrayed in the beach cemetery artifacts (Fig. 6.2; Plate 87) include avians; Fregatidae (Pl.52), Crax rubra (Pl.61), Ara macao, Cathartes aura (vulture), Tytonidae (owl: Pl.87); bats Chiroptera (Plate 87). Fish;

ICONOGRAPHY DEPICTED IN NACASCOLO ARTIFACT ASSEMBLAGES
OP. 8A-M

TAXA	ENGLISH/SPANISH	ART# Type	ASSOCIATIONS BURIAL
<u>FISH</u>			
CV	<u>Raja</u> sp. Ray/Raya Corriente Pez diablo	164 Carrillo	Urn burial
CV	Bothidae Lenguado	64 Piches Red	49 infant 25 male old adult
CV	Bothidae Lenguado	196 Galo	72 Infant
<u>REPTILIA</u>			
CV	Testudinata Turtle/Tortuga	88 Piches Red	25 male old adult
CV	Testudinata Turtle/Tortuga	150 Charco	51&52 infants
CV	(Mythic) Feathered serpent Serpiente emplumada	113 Papagayo	36 female? adolescent
<u>AVES</u>			
M	<u>Ara macao</u> Scarlet macaw/Lapa	109	34 female middle adult
CV	<u>Crax rubra</u> Currasow/Pavon	112 Tola	34 female middle adult
CV	Fregatidae Frigate/Fragata	5 Piches Red	25 male old adult
CV	<u>Cathartes aura</u> Vulture/Zopilote	43 Carrillo	34 female middle adult
CV	Tytonidae Owl/Luchusa	13 Chavez	
CV	Tytonidae Oropopo Owl/Luchusa	333 Red Ware(Leon)	106 male middle adult
CV	? Bird/Pajaro ro	145 Beige Ware	46 female middle adult
CV	? Bird/Pajaro	193 Beige Ware	47 female adult
CV	? Bird/Pajaro	255 Red Ware	78 unexcavated
CV	? Bird/Pajaro	79 Tola	33 male? adult



CV	<u>Cathartes aura</u>	Vulture/Zopilote	43	Carrillo	34 female
CV	Tytonidae	Owl/Luchusa	13		middle adult
CV	Tytonidae	Oropopo Owl/Luchusa	Chavez 333		106 male middle adult
CV	?	Oropopo Bird/Paja ro	Red Ware(Leon) 145		46 female middle adult
CV	?	Bird/Pajaro	Beige Ware 193		47 female adult
CV	?	Bird/Pajaro	Beige Ware 255		78 unexcavated
CV	?	Bird/Pajaro	Red Ware 79		33 male? adult
CV	?	Bird/Pajaro face missing	Tola 105 Carrillo		33 male? adult
<u>MAMMALIA</u>					
CV	<u>Chiroptera</u>	Bat/Murcielego	115	Piches Red	Cache 3
CV	<u>Dasyopus sp.</u>	Armadillo	90		Arts 89, 90, 91 Ft.1
CV	<u>Narica narica</u>	Pisote	194	Brown ware	44 male young adult
CV	Felidae	Feline/Felina Possible jaguar	209	Brown Ware	53 male middle adult
CV	Felidae	Feline/Felina Jaguar or Ocelot	35	Potosi Applique	9
C	Cervidae	<u>Odocoileus</u> Deer/Venado	Mora 8H 2(20-40)		
C	Cervidae	<u>Odocoileus</u> Deer/Venado	8A 4(60-40)		
C	Cervidae	<u>Odocoileus</u> Deer/Venado	1(0-20)		
<u>HUMAN FIGURES</u>					
CV	<u>Homo sapien sapien</u>	Human figure/Figura	6	Ampompua	25 male old adult
CV	<u>Homo sapien sapien</u>	Human face/Cara	33		6
C	Possible human with Feline mix			Luna: cara	FT.15
<u>UNIDENTIFIED</u>					
CV	Turtle shell or boat?		69	Piches Red	13A, B infants
CV	Crawly figure		224	Guinea Incised	57, Group 2 middle-old adult female
CV	Head missing, has tail		16	Red ware	25 male old adult
C	Face, possible mask			Ft.14 Black ware	85 male young adult

Figure 6.2 CV=ceramic vessel C=sherd M=metate



CV	<u>Dasyopus</u> sp.	Armadillo	90	Arts 89, 90, 91 Ft.1
CV	<u>Narica narica</u>	Pisote	Brown ware 194	44 male young adult
CV	Felidae	Feline/Felina	Brown Ware 209	53 male middle adult
CV	Felidae	Possible jaguar Feline/Felina	Potosi Applique 35	9
C	Cervidae	Jaguar or Ocelot	Mora	
C	<u>Odocoileus</u>	Deer/Venado	8H 2(20-40)	
C	<u>Odocoileus</u>	Deer/Venado	8A 4(60-40)	
C	<u>Odocoileus</u>	Deer/Venado	1(0-20)	
HUMAN FIGURES				
CV	<u>Homo sapien sapien</u>	Human figure/Figura	6	25 male old adult
CV	<u>Homo sapien sapien</u>	Human face/Cara	Ampompua 33	6
C	Possible human with Feline mix		Luna: cara	FT.15
<u>UNIDENTIFIED</u>				
CV	Turtle shell or boat?		69	13A, B infants
CV	Crawly figure		Piches Red 224	57, Group 2 middle-old adult female
CV	Head missing, has tail		16	25 male old adult
C	Face, possible mask		Red ware Ft.14	85 male young adult
			Black ware	

Figure 6.2 : CV=ceramic vessel C=sherd M=metate



Rays (Pl.64), lenguado, Bothidae (Pl.63), turtles (Testudinata; Pl.63), armadillo, Dasypus sp. (Pl.87), Narica narica pizote (Pl.87), felines (Pl.87) and anthropomorphic creatures (Pl.48).

One Mora polychrome vessel exhibits some mesoamerican influence (Pl.68; Figure 6.3). A kan-cross is clearly portrayed; the major iconographic element depicts a jaguar.

The Papagayo vessel associated with Burial 36 (Pl.69), appears to be an undulating figure, perhaps a feathered serpent. It has also been identified as a "swimming figure," or a local copy of ideas emanating from Honduras and El Salvador (Marlynn Beaudry, personal communication); the borrowed traits are seen in the vessel form, image location on the lower registry, and, the iconography of the "swimming figure" (Fig. 6.4).

Symbolism and iconography also manifest the stone artifact assemblage. One of the legs of a metate found in the Nacascolo beach cemetery has been identified as a possible Lapa, Ara macao. Graham (1981) provides a good discussion of the Nicoyan iconographic tradition for ceremonial metates. The metate's imagery, according to Graham (1981:119):

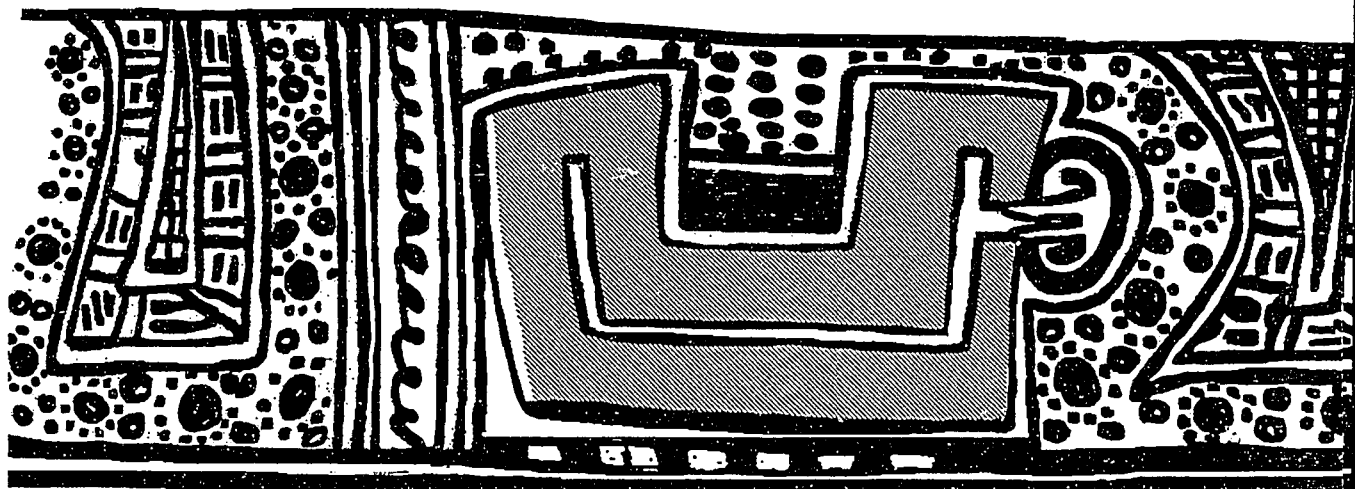
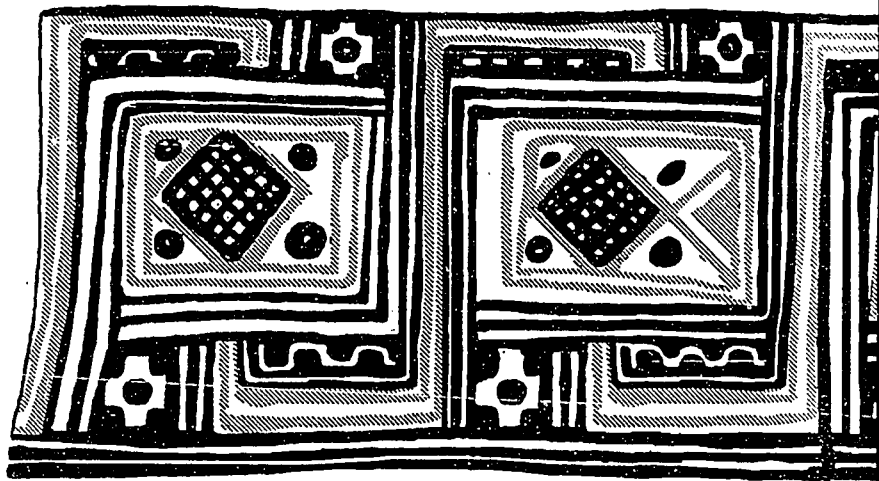

Red Painted



Black Painted



Beige Painted

Figure 6.3

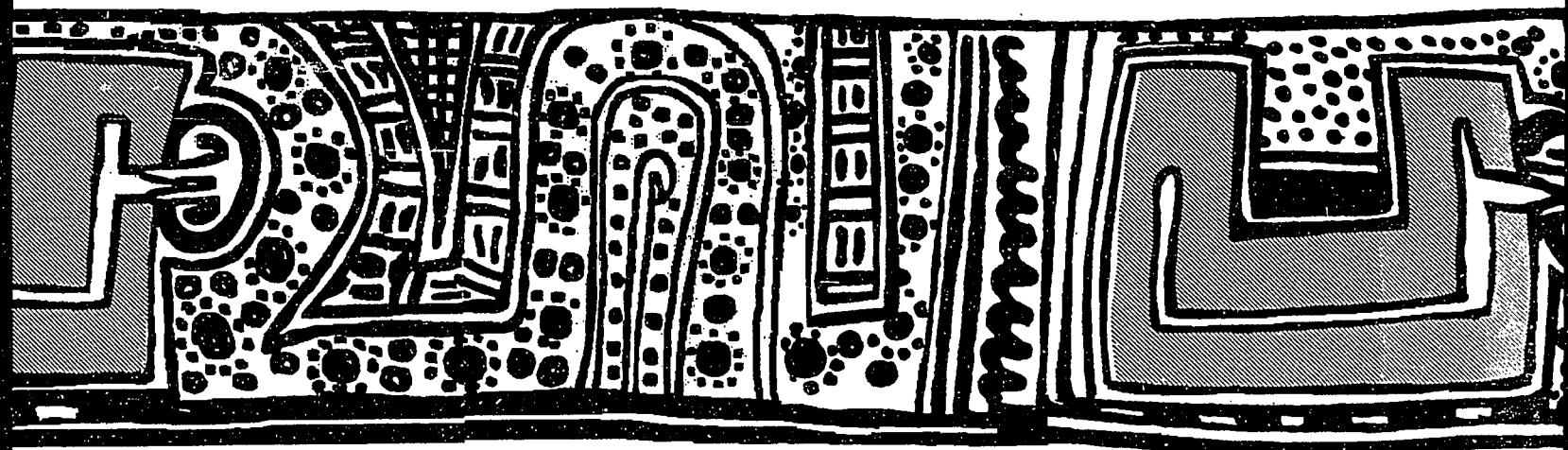
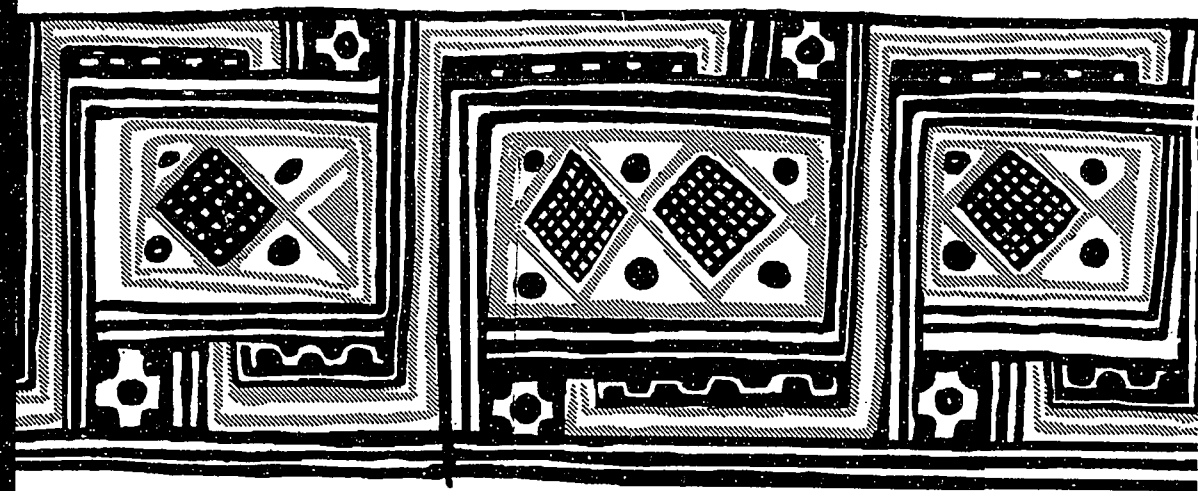

3



5cm

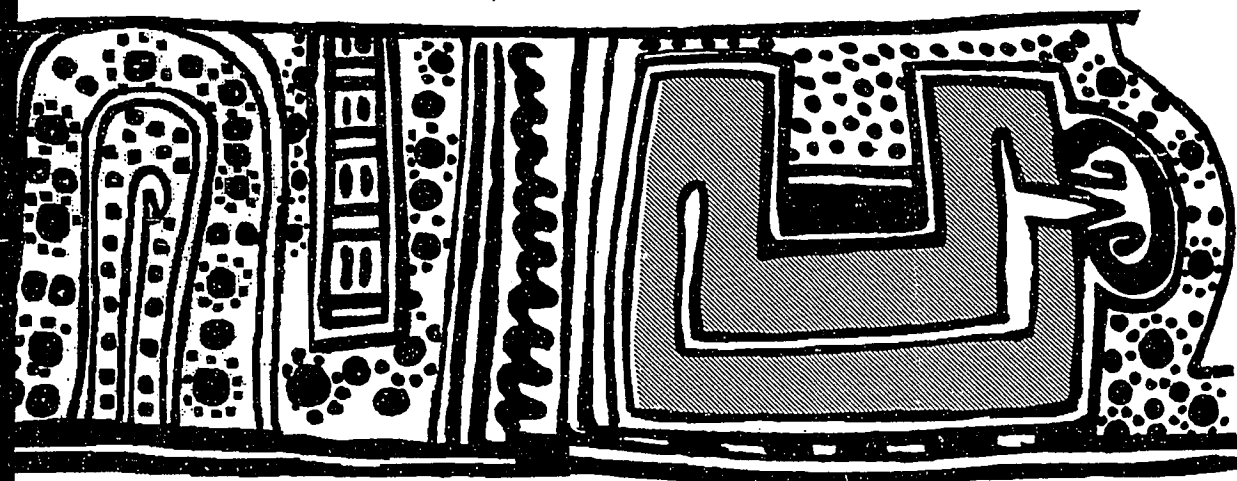
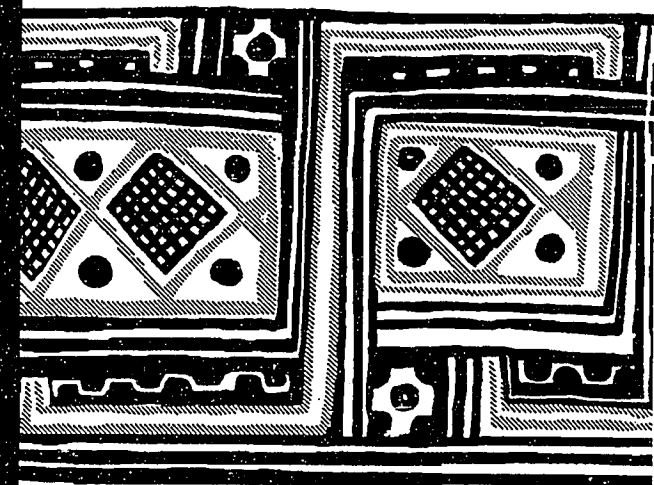

5cm

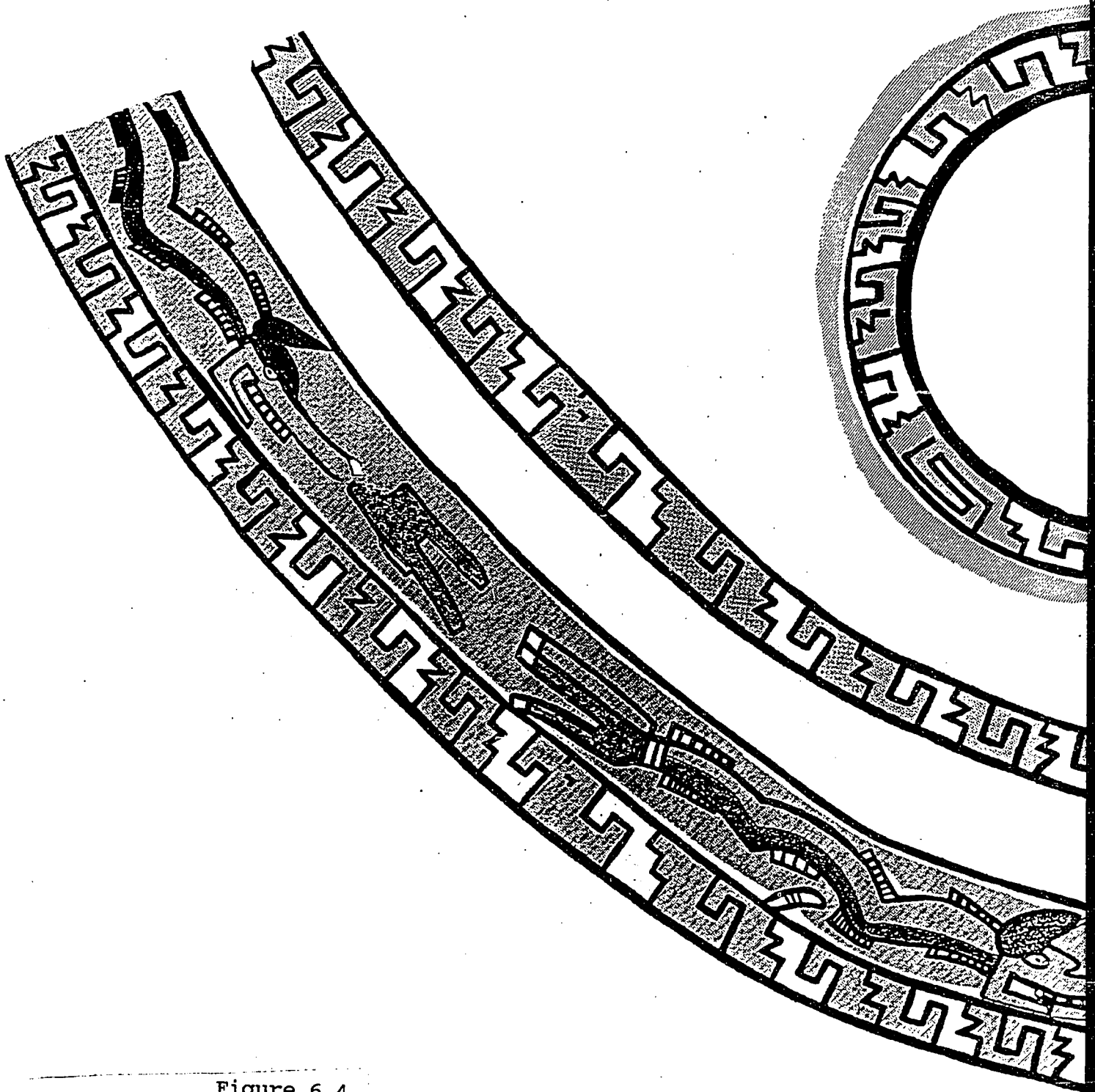
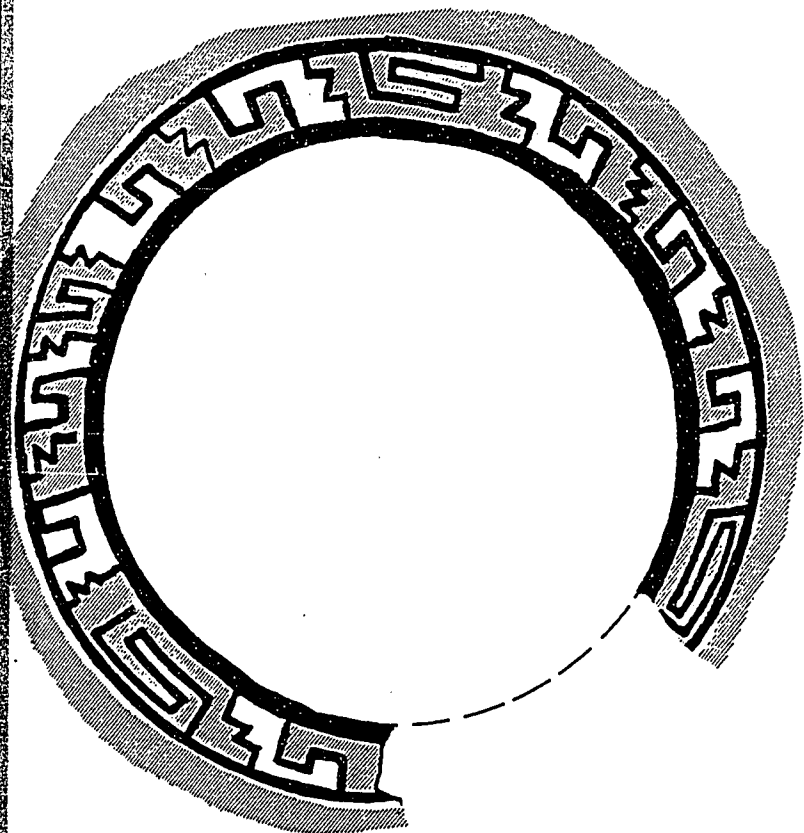

Figure 6.4



Black Painted



Worn, Black Painted



Orange Painted



White Painted

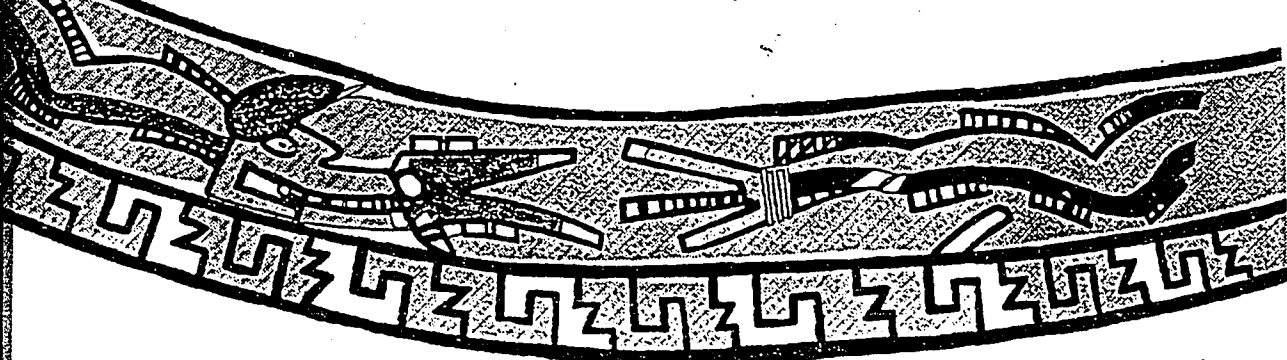
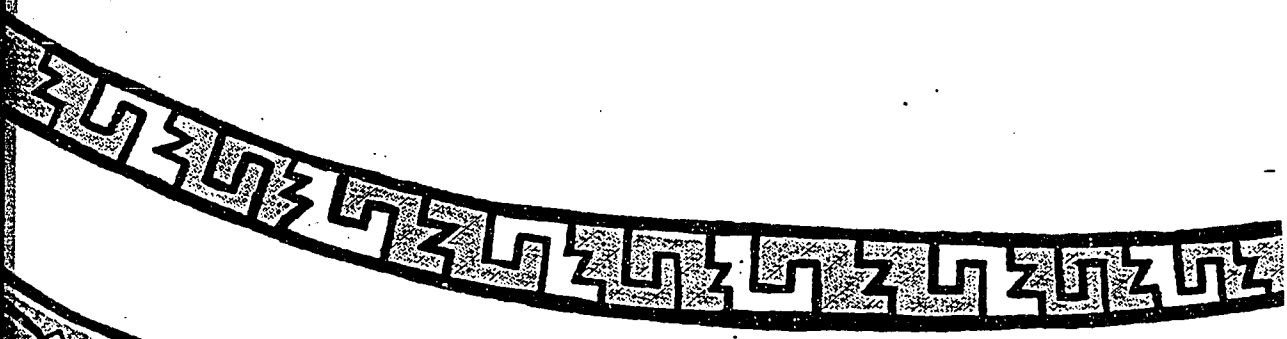

"The predominant metate imagery represent a cosmology in which raptors and parrots are the daytime sun, felines are the night sun in the underworld, canines are the night sun's escort and saurians are the earths surface."

It is fitting that the images depicted in the Nacascolo cemetery consist of saurians, avians, felines and reptiles; the animal ceremonialism expressed in the ritual canid burials and currasow (Crax rubra), deer and turtle, suggest further manifestation of Precolumbian beliefs.

As discussed in Chapter 1, there are several theories concerning the role of the metate in Nicoyan prehistory. Lothrop (1926), and Lange believe that metates were used as seats or thrones. Several ceramic vessels (none from Nacascolo) do show a person seated or reclining on a tetrapod metate. A vessel identified as from "Nicoya," a female seated on a tetrapod metate, is shown by Snarskis (1981:47 plate 16). Snarskis, disagreeing with the seat interpretation, cites the use-wear patterns evidenced on the Nacascolo metates, and argues for agricultural and/or ritual grinding activities. According to Graham (1980:115):

"Since the fine tripod metate was already established as a special purpose artifact in Mesoamerica before it appeared in Nicoya, there is no necessary relationship between these mortuary symbols and intensive agriculture in

Nicoya. The Nicoyan metates do show signs of wear probably used to grind maize for ritual consumption, not as a staple." (Graham 1980:115).

All five beach cemetery metates show evidence of wear; three are associated with manos, two (one elaborately carved) are not associated with manos.

The function and meaning of tripod metates seem quite different from the Mesoamerican tradition, at least according to Graham (1980:115).

"The Nicoyan objects have their closest formal link with a particular type of metate used for grinding maize in Mesoamerican highland regions. Tripod metates with a horizontal plate occur in Central Mexico at least by the beginning of Late Formative times, apparently as a counterpart of the utilitarian basin or slab metate (Tolstoy 1965:288). Both types were used for grinding maize, with the finer tripods probably reserved for special occasions and limited to wealthy or high-status households. From the Late Formative period on, tripod metates are found sporadically outside of Central Mexico invariably in ritual or elite mortuary contexts" (Chadwick 1965:665,671; Long 1966) in Graham 1980:115).

Graham continues:

"Since the metate as a tool was originally used to transform maize into flour for human consumption, the metate as primary mortuary symbol may have extended this concept, so that the object came to represent both elite control over food production and a place of transformation, above all in the realm of human life and death. In Nicoya, paradoxically, where maize was apparently not a staple at this time, the metate became a vital symbol, associated with death and perhaps with the promise of rebirth and new life" (1981:115-116.).

Although Graham was somewhat in error in excluding

maize as a staple, he is correct in equating the metate as a vital symbol, to Pasztory's (1978) major theme of transformation through death and rebirth, her synthesis of Classic period Mesoamerica iconography. Through the ability to transform plant to flour, rebirth through death, the powerful metate became emblematic of chiefly status (Ryder 1983).

In terms of labor expended in production, "decorated tripod metates were the most important component in a complex of functional stone sculpture which also included mace heads and axes" (Graham 1981:115.). This tripartite assemblage does not appear to have existed at Nacascolo; There is a lack of mace heads, and only plain axes made of volcanic stone with little elaboration have been found. Whereas all of these components need not appear together, the concept of the Zoned Bichrome mortuary complex centers around these elite objects (Tillett 1988).

Regardless of their specific use, metates required specialized manufacture, suggest the beginnings of differentiated social status and wealth, and their related symbols.

The early radiocarbon dates associated with infant remains, metate, mano, and jade bead (all symbolic

representations of fertility, rebirth, and water), suggest elaborate beliefs regarding subsistence activities, specifically agriculture, were in effect from early times.

As discussed in Chapter 2, ethnohistoric sources from Mesoamerica indicate infant sacrifices were made to the rain god Tlaloc, for agricultural prosperity, often in times of stress (Thompson 1970). Among the Nicarao and Chorotega infants were sometimes sacrificed (Oviedo 1976). It is possible that these infants, associated with such socio-ideo-technic (Binford 1971) offerings, were sacrificed.

Marine influence is likewise expressed in mortuary behavior. Some burial pits contain shell covers; Feature 10 is a fish burial; two concentrations of burnt Strombus granulatus form Features 8 and 9; and a moderate tool kit comprise the shell assemblage. Several taxa of fish effigies, and reptiles are identified in the beach cemetery ceramics.

In light of the antiquity of particular artifact assemblages found in the beach cemetery, and the late evidence of the Nacascolo shell mounds (@700 A.D.), it is likely these people entered the area as agriculturists and adapted to a marine environment. This is evident in the

stone artifact assemblage, the development and elaboration of the shell tool assemblage, the beginnings of shell mounds found around Nacascolo, concentrations of shell and sherd covering burials, and the construction of fish traps along the rugged coast to the north of Nacascolo (Vazquez and Gutierrez, personal communication).

Early Zoned Bichrome burials have no shell but by the end of the period a shell assemblage is present and becomes more elaborate through time. Early Polychrome period burials have more variation in their flexed position than those of the Zoned Bichrome Period; they are differentiated, in general, by the quantity of grave offerings associated with each burial, and elaboration of artifact assemblages. All these suggest increasing social complexity.

By the Middle Polychrome period burial practices we saw beginning to change in the Early Polychrome period are well established throughout Nacascolo and the region. This change is seen in burial position from predominantly flexed to extended; change is recognized in the quantity and quality of ceramics and types of grave offerings; a change from placing rocks over burials or marking burial areas to concentrations of sherds and shell; a change in burial location from interment in the beach cemetery to

other areas around Nacascolo in shell mounds and in and around habitation areas; and perhaps a change in ideology (as evidenced from ceramics and metates) which suggests change from an emphasis on shamanic, human/animal concepts to more politically oriented ones emphasizing special relationships with the supernatural and influences of elites from El Salvador and Honduras as seen in the swimming figure on the Papagayo vessel; a local copy of the Uloa-inspired swimming figure.

Grave Offerings and Precolumbian Social Structure

Grave offerings associated with the earliest burials consist mainly of ceramics; as the period progresses, a few individuals are found with shell, stone, and a few bone artifacts. Some burials are provided a number of grave offerings, while over 25% are not associated with any. Grave offerings are not placed in any one specific location such as above the head but vary from individual to individual and are not governed by age or sex, and are found on top of the head, to the right or left side, over the pelvic region, at the feet; burial offerings cross-cut age and sex divisions typical of ranked (Service 1962) or stratified (Fried 1960) societies. On a complexity continuum with sites such as Sitio Conte, and Venado on one end of the spectrum, and Lowland Caribbean tribes on

the other, Nacascolo would rest somewhere to the right of center.

A Zoned Bichrome burial complex has been postulated based on evidence first excavated by Hartman at Las Huacas. Considered an elite burial complex (Lange 1984; Snarskis 1984) composed of metates, carved stone mace heads, jadeite or greenstone ax-god pendants, and Rosales Zoned Engraved pottery. As a group these objects form a symbolic view of the universe held by Greater Nicoya society (Tillett 1988). In actuality, not all objects are present in all cases, in fact, rarely are they found together, or in great quantities outside Las Huacas and private collections. But using this quadpartite burial complex as a base of comparison, we can see how the Nacascolo mortuary data compare with the region. One basis of comparison involves quantification of esoteric elements involved in the burial ritual. Part of the precolumbian belief system involves the concept of power as knowledge and the quest for esoteric knowledge or emblematic symbols of authority, as characterized by Panamanian chiefdoms (Helms 1979). Valuables acquired and displayed by the elite receive "inherent" sacred value. This sacrality can be expressed in several ways. The items may have been carved or painted to illustrate symbolic representations or metaphors of sacredness and

power. The goods used in chiefly exchanges, distributions, and displays must be scarce commodities: and as such these items are frequently exotic goods. A chiefs generosity has significance only in relation to the constant of scarcity. Resources are considered exotic if they are not required for basic subsistence or household needs, if they are not readily available in great quantity, if they are received from geographically distant sources, or if they require exceptional craft skills to produce (Helms 1979:75).

As mentioned in Chapter 1, the number of metates recovered from Las Huacas contrasts dramatically with the number recovered from controlled excavations since Hartman's time. This significant point, while noted by Ryder (1983:44), is left unexamined. Despite Ryder's excellent study detailing spatial and chronological distribution of carved metates, his acknowledgement of the technical and artistic expertise required of this tradition, and the assumption of specialized production centers, he fails to offer any suggestions for production sites. Las Huacas also has the largest collection of celts and mace heads. Some ceramics were recovered but not in any way appropriate to say much about them except for a number of miniature vessels were recovered, as well as a couple of large ones. In light of the quantity and

quality of metates found at Las Huacas, and the paucity of evidence from controlled excavations, it is obvious that Las Huacas is hardly representative of general regional mortuary practices at that time. On the contrary, Las Huacas may be better considered an anomaly; I suggest Las Huacas was a production center of carved metates, the cemetery a repository for many of the stone cutters who made them. Specialists, most likely, held a venerable position within the society because they could transform raw material into something of great social value. Las Huacas is everything but typical of general mortuary practices. The fact that the considerable material derived from Las Huacas has unduly influenced archaeologists and their interpretations, underscores an inherent problem in comparing looted objects and undisturbed contexts.

If one ignores the thousands of metates, celts, jade, mace heads etc. reported from Las Huacas, and focuses on a comparison of associated remains, the number of grave offerings, including metates, associated with individuals or caches compares favorably with Nacascolo. Not all burials at Las Huacas are provided grave offerings, let alone elite offerings. One of the richest caches excavated by Hartman contained only three metates and less grave offerings than Burial 34 at Nacascolo. This

suggests that while Las Huacas may have been a stone craft production center, with something exotic to offer elites, access to elite goods manufactured at Las Huacas were just as restricted as those imported. Near Bagaces, sites have been reported to have large quantities of metate and jade fragments on the surface (Eduardo Odio Orozco, personal communication). Apparently, at some sites these items were more accessible than at Nacascolo.

I've suggested the beach cemetery was a corporately owned cemetery in the sense that the local people were granted rights and access to burial in this cemetery and had limited access to other areas of the site such as the valley floor and hillsides which are likely prestigious burial grounds (Hardy 1983). It has also been suggested that the beach cemetery was the burial ground of the common people (Dillon 1980). We find those with few or no associated grave offerings and those associated with a number of grave offerings including what are considered high prestige elite items such as elaborately carved metates, jade, and fine ceramics. These objects however do not appear to be common, nor does access to one exotic good necessarily permit access to other restricted objects, suggesting access to these types of goods was restricted even among elites. Of the 120 burials and 424 artifacts excavated, only one jade pendant and one jade

jade bead were found; one of the five metates is elaborately carved; three associated with ellipsoidal manos. This type of mano is only associated with metates; whereas other types of manos are not found with metates.

To what degree then was this strictly a "commoners" cemetery? Surely those few with the most grave goods or restricted grave offerings must be considered elite. How then do they compare among each other in the beach cemetery and with other alleged elite burials around Nacasclo and what significance may be attributed to their burial location? Analysis of the number of ceramics associated with each individual suggests stratification among burials (Figure 6.5); 33% are not associated with any ceramics; 37% with 1-2 ceramics; 16% with 3-4; 8% 5-6; and less than 3% with 8-14 ceramics.

Furthermore, the Nacasclo burials with the more ceramics tend to have grave offerings from other artifact assemblages, and there is more iconography and symbolism expressed in their burials. I cant say for certain exactly what each level means, surely each arbitrary level is just that, but the stratification revealed is more complex than previously thought, and is comparable to other burial populations within the region.

HYPOTHESIZED HIERARCHY BASED ON NUMBER OF CERAMIC GRAVE OFFERINGS
 NACASCOLO BEACH CEMETERY OP.8A-M

AGE	TOTAL CERAMICS PER BURIAL											% TOTAL
	0	1	2	3	4	5	6	7	8	9	14	
OLD ADULTS 55+ yrs.	1.0	1.0	0	1.0	1.0	1.0	0	1.0	1.0	0	0	6.73
MIDDLE ADULTS 35-54	6.7	4.8	4.8	1.0	1.0	0	1.9	0	0	1.0	1.0	22.1
YOUNG ADULTS 20-34	9.7	1.9	1.9	1.0	1.9	0	2.0	0	0	0	0	17.95
ADULTS 20-?	0	1.0	1.0	1.0	1.0	0	1.0	1.0	0	0	0	5.77
16-19	4.8	1.9	1.0	0	0	0	0	0	0	0	0	7.69
12-15	1.9	1.9	0	0	0	0	1.0	0	0	0	0	4.81
8-11	0	0	0	0	0	0	0	0	0	0	0	0
4-7	3.8	1.0	1.0	0	0	0	0	0	0	0	0	5.77
0-3	5.8	5.8	5.8	2.9	2.9	1.0	1.0	0	0	0	0	25
?	1.0	1.9	0	1.0	0	0	0	0	0	0	0	3.85
ALL	35	21	15	7.7	7.7	1.9	6.7	1.9	1.0	1.0	1.0	100%
*	35	36		15.4		8.6		5				100

* Percentage of individuals per hypothesized hierarchical level

Figure 6.5

Mortuary practices and comparative artifact assemblages indicate close ties between Culebra Bay sites of Vidor, Puerto Culebra, Monte del barco, Papagayo, and Nacascolo. The Tempisque River Valley site of Hacienda Mojica (Ryder 1980) show similarities with Nacascolo. No skeletal remains have been recovered from Mojica, but Tola, Guinea Incised, Charco Black on Red, and Carrillo Polychrome vessels were prominent grave offerings. Ryder also noted that Mojica had a higher percentage of Atlantic ceramics than had previously been found in Guanacaste. This is not surprising due to its intermediate location. No metates or jade were found at Mojica (Ryder 1986). At Reinaldo the individual with the most grave offerings had 14 vessels, jade pendants, and a stone figure.

Burial 34 represents the most complex burial in the Nacascolo beach cemetery. She had two metates one carved in low relief with double-headed bird figures and five ceramic vessels placed directly over semiextended on her left side burial position. Two separate burial caches including another mano and metate and three ceramic vessels. Ceramics indicate this burial as Early Polychrome Period (500-700 A.D.). Plain tripod metates are found from 200-700 A.D.; the more elaborate low relief incised metate somewhat later.

Why this individual is buried here in the beach cemetery is uncertain. It is possible she was not allowed access to the more prestigious hillside area because hillside burial was sex determined. There isn't evidence to support this idea because the sex of the individual in the cist tomb is unknown. No artifacts strictly reserved for males were found; the types of associated grave offerings cut across sex and age boundaries. They do share burial characteristics; both are in stone structures, both evidence burning of some kind at the time of burial. Both are associated with grave offerings considered elite items (e.g. metates). The double bird-headed incised metates found with both of these individuals are nearly identical, the metate in the cist tomb associated with an overhang mano.

While the cist tomb is more structurally complex than the stone filled-hearth/burial pit of Burial 34; the quality and quantity of grave offerings associated with the woman on the beach surpasses that of the cist tomb. In comparison to the stratification evidenced by the number of associated ceramics in the beach cemetery, the female on the beach has far more 14:4; and more metates 3:1. The ceramics associated with the beach cemetery burial are earlier than those associated with the cist tomb. The beach grave ceramic offerings have applied

animal effigy heads, wings, and tail. Among the cist tomb ceramics we find latter vessel forms and one whose cylindrical body and slab feet evidence Mesoamerican influence.

The social complexity of Greater Nicoya societies, long accepted as chiefdoms, has lately come under attack by archaeologists. Creamer and Haas (1985) argue against the accepted "chiefdom" form of social organization, believing the Greater Nicoya societies were more organized along "tribal" lines. Contrary to this opinion, the data presented in this dissertation, suggest that the Culebra bay, particularly the Nacascolo site, reflect more of a "chiefdom" level of social complexity. Evidence indicates that the presence of grave goods as well as burial position crosscuts age and sex divisions typical of ranked (Service 1962) and/or stratified (Fried 1966) societies. According to Earle (1978:11): "Chiefs are distinguished as general leaders in all group affairs- economic, political, and religious - but there is no specialization of leadership roles except as to level in the hierarchy."

Both burials 34 (beach cemetery) and 3A (the cist tomb) are differentiated from the others in these respects. Both burials would have required the greatest energy expenditures, in both grave content and

construction, and both have symbols representative of a religious belief system (the iconography expressed on the metates, mano, and ceramics), not to mention the possibility that some items are imported from a distance.

Across the bay from Nacascolo at Playa Panama, Weaver and Vazquez (1980) analyzed the remains of approximately 172 burials from a cemetery composed largely of women and children. Specific mortuary behavior regarding positioning and associations for all burials is unknown. Exactly what connection, if any, this cemetery shares with Nacascolo is also unknown at this time. It is interesting to note these specialized burial areas and speculate on possible hierarchical levels, as well as restrictions and/or rights governing access to deposition in these areas.

Conclusions

It is possible that the beach area was used for everyone in early times of site occupation, then a shift to elite interment in more prestigious areas as increasing social complexity necessitated additional distinctions between elites and commoners. I suggest the extended burial position was first used for the elites. This is based on the size and shape of the cist tomb which suggest

an extended burial with the grave offerings placed above the head and at the feet. The ceramics associated with this burial place it within the Early Polychrome Period. Extended burials in the beach cemetery are not noticed until the Middle Polychrome Period, possibly late Early Polychrome if one accepts Cabuyal and Apompua Modelled at this time; a time when burial practices change from a predominantly flexed position to an extended position. It is possible that the extended burial position was first accorded elites and over time the practice was allowed commoners, much in the same way that mummification in Egypt was first reserved for the pharaohs later becoming the norm for nobles and commoners.

According to the mortuary evidence, the Nacascolo beach cemetery was used from the beginning of site occupation. As society became more complex, more components were added to burial ritual, more grave offerings were invested. More structure, of circular nature is added, burning becomes primary mortuary expression. As social complexity increases, perhaps thrust by foreign influence from the north, a change in mortuary behavior, as evidenced by change in location and burial style, erupts to accommodate and further distinguish, new status and power. At this time, the hillsides and valley floor were used for elite burials

beginning in the Early Polychrome Period. This is based on the quantity and quality of grave offerings usually associated with elites, an assessment of labor required to complete the size and complexity of grave construction and structural components, and the number of mortuary practices invested in the burial ritual. In one case this is estimated from the size of a looters pit, and the stories which have survived concerning the excavation of the hueco grande, the very large (over 5 meters in diameter), excavations of Juan Dada.

Given the archaeological evidence, I can say that mortuary practices within Culebra Bay consist of primary and secondary burial in specialized or elite burial areas with restricted access based on age, sex, status, or familial associations, common burial areas, under stone structures, in and around habitation areas, in shell mounds; some individuals were placed in urns, and then interred. Not all mortuary practices are contemporary, on the contrary, differentiation among particular practices often reflect temporal, social, and perhaps spatial distinctions.

Just as mortuary evidence suggests hierarchies for commoners and elites, there is also an apparent site hierarchy. This hierarchy is dependant upon access to

exotic resources, as well as their position along the exchange route.

As has been expressed by Lange (1971) and Sweeney (1975:39) the inclusion of Nicoya into Mesoamerica is unwarranted. The material of Guanacaste/Nicoya sites attests indigenous syncretic culture characteristic of the Intermediate area. I agree. The Nacascolo data suggest the same. It appears that the majority of decision making takes place on the local level with variation dependant upon social structure, site hierarchy, local resources and the environment.

The Nacascolo data are important because they provide a large sample from which aspects of precolumbian social organization may be obtained including; social structure and complexity; demographic aspects and paleopathology assessments. It portrays mortuary practices over an extended period of time. It allows identification of gender-specific artifacts which, may distinguish social status when not apparently gender related. Artifact analyses shed light on subsistence activities and provide evidence for what these people thought important enough to include with their dead. It provides a large sample of whole vessels which answer chronologic and stylistic questions.

Mortuary remains provide evidence of ritual activities and exemplify aspects of the precolumbian belief system so difficult to attain archaeologically. It provides answers to many unanswered questions posed by archaeologists lacking clear-cut associations and/or osseous remains. It disproves inaccurate statements made by archaeologists based on limited, biased, or negative evidence.

Excavation of the Nacasclo beach cemetery is of humanistic value in that the grave contents and associations not only provide insights into precolumbian life, but, through analysis of mortuary behavior, one actually acquires knowledge of human groups, whose only evidence of their existence, their history, is expressed in the archaeological record.

BIBLIOGRAPHY

Abel-Vidor, Suzanne

1980a Dos hornos Precolumbinos en el sitio Vidor, Bahía Culebra, Costa Rica. Vinculos 6 (1-2):43-49.

1980b The Historical Sources for the Greater Nicoya Archaeological Sub-Area. Vinculos, vol.6, nos.102:155-176. Museo Nacional de Costa Rica, San Jose.

1981 Ethnohistorical Approaches to the Archaeology of the Greater Nicoya. In Between Continents/Between Seas: Precolumbian Art From Costa Rica, 85-92, Elizabeth Benson, ed., Henry N. Abrams Inc., New York.

Accola, Richard M.

1978 A Decorative Sequence of Prehistoric Ceramics from the Vidor Site, Guanacaste, Costa Rica. M.A. thesis, Department of Anthropology, University of Texas, Austin.

Accola, Richard M.

1978b Revision de los tipos de ceramica del Periodo Policromo Medio en Guanacaste. Vinculos 4:80-105, Museo Nacional de Costa Rica, San Jose.

Accola, Richard M. and Peter R. Ryder

1980 Excavaciones en el sitio Monte del Barco, Bahía Culebra. In Vinculos 6(1-2):67-79. Museo Nacional de Costa Rica, San Jose.

Acton, Rad and Mark Frankel

1977 A Study of Selected Burials from the Vidor Site. MS. on file Biblioteca Antropologica y Historia, Museo Nacional de Costa Rica, San Jose.

Agrinier, Pierre

1978 A Sacrificial Mass Burial at Miramar, Chiapas, Mexico. Papers of the New World Archaeological Foundation, no.42. Provo, Utah.

Baker, Brenda J. and George J. Armelagos
1988 The Origin and Antiquity of Syphilis:
Paleopathological Diagnosis and Interpretation.
Current Anthropology, vol.29, no.5:703-738. Chicago.

Barrantes, Francisco Montero
1891 Apuntamientos sobre la Provincia de Guanacaste en la
Republica de Costa Rica. Tipografia Nacional, San
Jose.

Bartel, Brad
1982 A Historical Review of Ethnological and
Archaeological Analyses of Mortuary Practice.
Journal of Anthropological Archaeology, vol.1,
no.1:32-58, Robert Whallon, ed..

Baudez C.F.
1958 Provisional Assessment of Two Field Seasons At the
Site of Papagayo 1958-1959. 6 pages, translation
Suzanne Abel-Vidor. MS. on file Museo Nacional de
Costa Rica, San Jose.

1960 Preliminary Report on the Activities of the Mission
December 1959-January 1960. 6 pages, translation
Suzanne Abel-Vidor. MS. on file Museo Nacional de
Costa Rica, San Jose.

1960 Preliminary Report on the Activities of the Mission
10 February-15 May 1960. 5 pages, translation
Suzanne Abel-Vidor. MS. on file Museo Nacional de
Costa Rica, San Jose.

Baudez, Claude F.
1967 Recherches Archeologiques dans La Vallee du
Tempisque Guanacaste, Costa Rica Institut des
Hautes Etudes de L'Amerique Latine, Paris.

Baudez, Claude F.
1970 Amerique Centrale. Les Editions Nagel, Geneve.

Bernstein, David J.

- 1980 Artefactos de piedra pulida de Guanacaste, Costa Rica: una perspectiva funcional. Vinculos 6(1-2): 141-153. Museo Nacional de Costa Rica, San Jose.
- Bernstein, David J.
 1984 Utilitarian Lithics as Prestige Items: A Preliminary Examination of Some Lower American Mortuary Practices. In Interregional Ties in Costa Rican Prehistory, Esther Skirboll and Winifred Creamer, eds. BAR International Series 225, 203-219.
- Binford, Lewis
 1971 Mortuary Practices: Their Study and Potential. In Approaches to the Social Dimensions of Mortuary Practices. Memoirs of the Society for American Archaeology, no.25, James A. Brown, ed., 6-29.
- Binford, Lewis
 1972 An Archaeological Perspective. Seminar Press, New York.
- Bird, Junius B.
 1948 Preceramic Cultures in Chicama and Viru. An Appraisal of Peruvian Archaeology. Memoirs of the Society for American Archaeology, no.4:21-28.
- Blanco Vargas, Aida M y Silvia Salgado Gonzalez
 1980 Rescate Arqueologico Del Sitio 26-CN-Barrial de Heredia. V Centenario de Gonzalo Fernandez de Oviedo, Memoria del Congreso sobre el Mundo Centroamericano de su Tiempo, Nicoya, Costa Rica, America Central. Publicacion de la Comision Nacional Organizadora, 133-147.
- Bonilla, Leidy D, Marlin Calvo M and Sylvia Salgado
 1986 Interpretaciones Preliminares del Sitio G-227-Salinas, Bahia Culebra. In Prehistoric Settlement Patterns in Costa Rica. Journal of the Steward Anthropological Society, vol.14, nos.1 and 2:45-66, 1982-83, Frederick W. Lange and Lynette Norr, eds., Urbana.
- Bovallius, Carl
 1896 Nicaraguan Antiquities. Swedish Society of

Anthropology and Geography. Stockholm. Reprinted by Banco de America-Cultural Promotion Fund, 1970, Managua.

Bozzoli de Wille, Maria E.

- 1975 Birth and Death in the Belief System of the Bribri Indians of Costa Rica. Doctoral dissertation, University of Georgia, University Microfilms International, Ann Arbor, Michigan.

Bozzoli, Maria E.

- 1979 El Nacimiento y la Muerte Entre Los Bribris. Editorial Universidad de Costa Rica

Bradley, John E.

- 1984 The Silencio Funerary Sites, Vinculos, vol.10, no.1-2:93-114. Museo Nacional de Costa Rica, San Jose, Costa Rica.

Bransford J. F., M.D.

- 1881 Archaeological Researches in Nicaragua. Smithsonian Contributions to Knowledge no. 383, Smithsonian Institute, Washington. Reprint: Coleccion Cultural- Banco de America, Nicaragua.

Briggs, Peter S.

- 1986 Pre-conquest Mortuary Arts and Status in the Central Region of Panama. Doctoral dissertation, University of New Mexico, Albuquerque. University Microfilms International, Ann Arbor, Michigan.

Broadbent, Sylvia M.

- 1964 Los Chibchas. Serie Latinoamericana no.5. Facultad de Sociologia, Universidad Nacional de Colombia.

Brown, James A.

- 1971 Introduction. In Approaches to the Social Dimensions of Mortuary Practices. Memoirs of the Society for American Archaeology, no.25, James A. Brown, ed., 1-5.

Brown, James A.

- 1990 More Mystery from the Spiro Site. Paper presented

at the 55th Annual Meeting of the Society for
American Archaeology, Las Vegas, Nevada.

Bruhns, Karen Olsen

- 1982a Dating the Sculpture of San Agustín: A Correlation
with Northern Peru. In Pre-Columbian Art History,
Selected Readings, Alana Cordy-Collins, ed. Peek
Publications, Palo Alto, California, 193-204.

Bruhns, Karen Olsen

- 1982b A View From the Bridge: Intermediate Area Sculpture
in Thematic Perspective. Baessler-Archiv, Beitrage
Zur Volkerunde. Herausgeben im Auftrage des
Museums fur Volkerkunde Berlin, Statl. Museum
PreuBischer Kulturbesitz von K. Krieger und G.
Koch, Neue Folge Band XXX (Lv. Band) Verlag Von
Deitrich Reimer. Berlin.

Buikstra, Jane and Gordon C. C.

- 1981 The Study and Restudy of Human Skeletal Series:
The Importance of Long-term Curation. Annals of
the New York Academy of Sciences, vol. 376:449-465,
New York.

Bushnell, G.H.S.

- 1951 The Archaeology of the Santa Elena Peninsula in
South-West Ecuador. Cambridge at the University
Press.

Cabrera, Victor M.

- 1924 Guanacaste. Libro Conmmemorativo del Centenario de
la incorporacion del Partido de Nicoya a Costa Rica.
San Jose.

Chamberlain, Karen

- 1991 Bones and Stones and Things Made of Clay An
Archaeological Survey of Hacienda Los Inocentes.
Unpublished Senior Thesis, Kenyon College,
Associated Colleges of the Midwest Tropical
Research. On file MNCR.

Chapman, Anne MacKaye

- 1958 An Historical Analysis of the Tropical Forest
Tribes on the Southern Border of Mesoamerica.

Doctoral dissertation in Political Science,
Columbia University, University Microfilms
International, Ann Arbor, Michigan.

Chapman, Anne M.

- 1960 Los Nicaraos y Los Chorotega Segun los Fuentes Historicas. Publicaciones de la Universidad de Costa Rica, Serie historia y geografia no. 4, Ciudad Universitaria, Costa Rica.

Chenault, Mark L.

- 1984 Test Excavations at Neblina and Las Piedras. Vinculos 10(1-2):115-120. Museo Nacional de Costa Rica, San Jose, Costa Rica.

Cockburn, John

- 1962 Un Viaje por Tierra desde el Golfo de Honduras hasta el Gran Mar del Sur. In Los Viajes de Cockburn and Lievre. Spanish translation of 1735 english edition by D. Carlos Melendez, Editorial Costa Rica.

Coe, Michael D.

- 1962a Preliminary Report on Archaeological Investigations in Coastal Guanacaste, Costa Rica. Atken, 34th. International Congress of Americanists, Vienna, 358-365.

Coe, Michael D.

- 1962 Costa Rican Archaeology and Mesoamerica. Southwestern Journal of Anthropology vol.18: 170-183. University of New Mexico, Albuquerque.

Coe, Michael D. and Claude F. Baudez

- 1961 The Zoned Bichrome Period in Northwestern Costa Rica. American Antiquity, vol.26, no.4:505-515.

Collier, Donald and Helen Chandra

- 1975 Catalogue to exhibit in Ancient Ecuador Culture, Clay and Creativity 3000-300 B.C., text by Donald W. Lathrop, Field Museum of Natural History, 72-110, Chicago, Illinois.

- Cooke, Richard G.
 1984. Birds and Men in Prehistoric Central Panama. In Recent Developments in Isthmian Archaeology: Advances in the Prehistory of Lower Central America. Proceedings of the 44th. International Congress of Americanists, Bar International Series 212. Frederick W. Lange, ed., 243-281.
- Cooke, Richard G.
 In Preliminary Observations on Vertebrate Food Avoidance Press by the Precolumbian Amerinds of Panama, with Comments on the relevance of the Behavior to Archaeozoology and Paleoenvironmental Reconstruction. In Prehistoric Environments in the New World Tropics. T. Vann der Hammen and C. Cortez Troncoso, eds., British Archaeological Reports.
- Cowgill, George L. Ruben Cabrera C., and Saburo Sugiyamamaya
 1990 Early Teotihuacan Rulership: New Evidence from the Feathered Serpent Pyramid. Paper presented at the 55th Annual Meeting of the Society for American Archaeology, Las Vegas, Nevada.
- Creamer, Winifred
 1983 Production and Exchange on Two Islands in the Gulf of Nicoya, Costa, A.D. 1200-1500. Ph.D. dissertation, Tulane University, University Microfilms International, Ann Arbor.
- Day, Jane Stevenson
 1984 New Approaches in Stylistic Analysis: The Late Polychrome Period Ceramics from Hacienda Tempisque, Guanacaste Province, Costa Rica. Doctoral dissertation, University of Colorado, Boulder, Anthropology Department, University Microfilms International, Ann Arbor, Michigan.
- Day, Jane Stevenson
 1988 Iconos y simbolos: la ceramica pintada de la region de Nicoya. Mesoamerica Año 9, Cuaderno 15: 137-161.
- Dengo, G.
 1962 Estudio Geologico de la Region de Guanacaste. Costa

Rica. Compania Petrolera de C.R., Imprenta del
Institute Geografica, San Jose.

Dillon, Brian D.

1980 Preliminary Report of Archaeological Excavations at
Nacascolo, Bahia Culebra (G89 NA). Paper on file
Archivo Depto. de Antropologia y Historia, Museo
Nacional de Costa Rica, San Jose.

Dillon, Brian D.

1982 Excavations from Nacascolo, Costa Rica. Unpublished
manuscript, copy provided by the author.

Duque Gomez, Luis and Julio Cesar Cubillos

1979 Arqueologia de San Agustin. Alto de Idolos,
Monticulos y Tumbas. Fundacion de Investigaciones
Arqueologicas Nacionales, Banco de la Republica,
Bogota.

Earle, Timothy

1977 Exchange Systems in Prehistory. Academic Press.

Eckholm, Gordon F. and Clifford E. Evans

1962 The Interrelationships of New World Cultures: A
Coordinated Research Program of the Institute of
Andean Research. Akten des 34th Internationaler
Amerikanisten Kongress, 253-265, Vienna.

Einhaus, C. Shelton

1980 Stone Tools from La Pitahaya (IS-3). In Adaptive
Radiations In Prehistoric Panama, Peabody
Museum Monographs Number 5:429-466, Harvard
University, Cambridge, Massachusetts.

Eliade, Mircea

1958 Rites and Symbols of Initiation-the Mysteries of
Birth and Rebirth. Harper Torchbooks, The Academy
Library, Harper and Row, New York.

Eliade, Mircea

1976 A History of Religious Ideas. Volume 1, From the
Stone Age to the Eleusinian Mysteries. Translated
from the French by Willard Trask. The
University of Chicago Press. 1978.

Faulwell, James A.

- 1970 A Burial Grouping with a Murillo Grooved Pot and Other Skeletal Material from the Las Marias Site. ACM paper #33, on file Depto. de Antropologia y Historia, Museo Nacional de Costa Rica.

Ferrero, Luis

- 1981 Costa Rica Precolumbina. Biblioteca Patria, no. 6. Fourth edition. Editorial Costa Rica, San Jose.

Ferrero, Luis

- 1989 Entre el Pasado y el Futero. Editorial Costa Rica.

Finch, Will O.

- 1986 A Preliminary Survey of Hacienda Jerico. In Prehistoric Settlement Patterns in Costa Rica. Journal of the Steward Anthropological Society, Frederick W. Lange and Lynette Norr, eds., vol.14, nos. 1 and 2, 1982-83:97-104, Urbana, Illinois.

Fleischhacker, Hans

- 1972 Prakolumbishe Skelettfunde von der Ometepe-Insel im Nicaragua-See. Atken XXXVIII International Congress of Americanists, 405-411, Munich. English translation by Richard Lange (1979), paper on file Depto. de Historia y Antropologia, Archivo Arqueologico, Museo Nacional de Costa Rica, San Jose.

Flint, Earl

- 1882 Antiquities of Nicaragua-Origin of the Palenque Builders. The American Antiquarian and Oriental Journal, vol.IV, no.4:289-302. Stephen D. Peet, ed., Chicago.

Fried, Morton H.

- 1960 On the Evolution of Social Stratification and the State. In Culture in History. Bobbs-Merrill reprint, S. Diamond, ed., New York: Columbia University Press: 713-731.

Fowler, Jr., William R.

- 1984 Late Preclassic Mortuary Patterns and Evidence for Human Sacrifice at Chalchuapa, El Salvador. American Antiquity 49(3):603-618.
- Fowler, Jr., William R.
1989 The Cultural evolution of Ancient Nahua Civilizations The Pipil-Nicarao of Central America. University of Oklahoma Press, Norman.
- Furst, Peter T.
1976 Hallucinogens and Culture. Chandler and Sharp Publishers, Inc. San Francisco.
- Gabb, William M.
1875 On the Indian Tribes and Languages of Costa Rica. Proceedings of the American Philosophical Society, vol. XIV, no.95:483-602.
- Gerhard, Peter
1960 Pirates on the West Coast of New Spain 1575-1742. A.H. Clark Co., Glendale.
- Goldstein, Lynn and Norman C. Sullivan
1986 People as Food, Bone as Ritual: Rethinking Old Data. Paper presented at the 51st. Annual Meeting of the Society for American Archaeology, New Orleans.
- Goodenough, Ward H.
1965 Rethinking 'Status' and 'Role': Toward a General Model of the Cultural Organization of Social Relationships. In The Relevance of Models for Social Anthropology, A.S.A. Monographs 1. Frederick A. Praeger, New York.
- Gostautas, Estanislao
1969 Arte Columbiano. Editorial Iqueima, Bogota, Columbia.
- Graham, Mark
1981 Traditions of Costa Rican Stone Sculpture. In Between Continents/Between Seas: Precolumbian Art of Costa Rica, 113-134, The Detroit Institute of Arts, Harry N. Abrams, Inc., New York.

- Greenwood, Roberta S.
 1969 The Browne Site: Early Milling Stone Horizon in Southern California. Society for American Archaeology Memoir 23.
- Guerrero, Juan Vicente and Aida Ma. Blanco Vargas
 1987 La Ceiba: Un Asentamiento del Policromo Medio en el Valle del Tempisque con Actividades Funerarias (G-60-LC). Tesis de Licenciatura, Universidad de Costa Rica, Facultad de Ciencias Sociales, Escuela de Antropología y Sociología.
- Haberland, Wolfgang
 1961 Two Shaman Graves in Central America. Archaeology vol.14, no.3:154-160.
- Haberland, Wolfgang
 yr? El cementerio Indigenia de Los Angeles, Nicaragua, Manuscript #1107, 8 pages, on file in Anthropology Library Museo Nacional de Costa Rica, .
- Haberland, Wolfgang
 1963 Conferencia y Exposición Arqueológica, in Nicaragua Indigenia, Órgano del Instituto Indigenista Nacional, vol.5, no.36: 25-39, Managua.
- Haberland, Wolfgang
 1973 Stone Sculpture from Southern Central America. In The Iconography of Middle American Sculpture, D. Easby, ed., 134-152.
- Haberland, Wolfgang
 1975 Further Archaeological Evidence For the Nicarao and Pipil Migrations in Central America. Proceedings XLI International Congress of Americanists, Mexico 2-7 de septiembre de 1974, vol.1:551-559, Mexico.
- Hamblin, Nancy
 1984 Animal Use by the Cozumel Maya. University of Arizona Press, Tucson.

- Hardy, Ellen T.
 1983 Some Possible Status Distinctions from Nacascolo, Culebra Bay, Costa Rica. Masters thesis, Archaeology Program, University of California, Los Angeles.
- Hardy, Ellen Teresa
 1988 Denuncia contra huaqueros encontrados en Playa Jicaro, Manuscript on file Museo Nacional de Costa Rica, Oficina del Registro.
- Hardy, Ellen
 1989 Preliminary Report on Archaeological Excavations Conducted At Nacascolo, Guanacaste, December 1988-February 1989. Manuscript on file Depto. de Historia y Antropologia, Museo Nacional de Costa Rica, San Jose.
- Hardy, Ellen T.
 1990 Mortuary Practices and Social Structure Among Precolumbian Inhabitants of the Bay of Culebra, Costa Rica. Paper presented at the 55th Annual Meeting of the Society for American Archaeology, Las Vegas, Nevada.
- Hardy, Ellen
 1991 Terms of Interment: Mortuary Practices of Northwestern Costa Rica. Paper presented at the monthly meeting of The Mesoamerican Network, Los Angeles County Museum of Art, May 12, 1991.
- Hartman, C. V.
 1901 Archaeological Researches in Costa Rica. The Royal Ethnographical Museum in Stockholm.
- Hartman, C. V.
 1907 Archaeological Researches on the Pacific Coast of Costa Rica, Memoirs of the Carnegie Museum, no.3, Pittsburg.
- Healy, Paul F.
 1980 Archaeology of the Rivas Region, Nicaragua Wilfred Laurier University Press, Ontario, Canada.

- Healy, Paul F.
1981 Los Chorotega y Nicarao: Evidencia Arqueologica de Rivas. Boletin Nicaraguense de Bibliografia y Documentacion, no.43:1-7. Banco Nacional de Nicaragua, septiembre-octubre, 1981, Managua.
- Helms, Mary W.
1979 Ancient Panama. University of Texas Press, Austin.
- Herrera, Carlos Enrique R.
1982 Sitio Nosara de Nicoya: Informe y Propuesta de Excavation. In Vinculos vol.8, nos 1-2:65-74. Museo nacional de Costa Rica, San Jose.
- Hodder, Ian
1982 The Archaeology of Mind. Cambridge University Press
- Hoopes, John W.
1980 Archaeological Investigations at the Site of La Guinea, Tempisque River Valley, Guanacaste, Costa Rica. Unpublished B.A. thesis, Yale University. Ms. on file Depatyamento de Historia y Antropologia, Museo Nacional de Costa Rica, San Jose.
- Hoopes, John W.
1984 A Preliminary Ceramic Sequence for the Cuenca de Arenal, Cordillera de Tilaran Region, Costa Rica. Vinculos 10(1-2):129-147, Museo Nacional de Costa Rica, San Jose.
- Hubbs, Carl L. and G. I. Roden
1964 Oceanographic and Marine Life Along the Pacific Coast. In Handbook of Middle American Indians, 1:143-187, Robert Wauchope, ed., University of Texas Press, Austin.
- Incer, Jaime
1985 Toponimias Indigenas de Nicaragua. Libro Libre, San Jose, Costa Rica.
- Janzen, Daniel H.

1983 Costa Rican Natural History. The University of Chicago Press.

Kennedy William Jerald

1968 Archaeological Investigations in the Reventazon River Drainage Area, Costa Rica. Doctoral dissertation, Tulane University, University Microfilms International, Ann Arbor, Michigan.

Kerbis, Julian

1980 The Analysis of Faunal Remains from the Vidor Site. Vinculos, vol.6, nos.102:125-140. Museo Nacional de Costa Rica, San Jose.

Kerbis, Julian

Feature record #32, Vidor site excavations. On file arquivo Depto. de Arqueologia, Museo Nacional de Costa Rica, San Jose.

Kidder, Alfred II

1940 South American Penetrations in Middle America. In The Maya and Their Neighbors. Second Edition, 1962:441-459, D. Appleton Century Company Incorporated, New York, .

Kirchoff, Paul

1943 Mesoamerica. Acta Americana, vol.1:92-107.

Kirchoff, Paul

1948a The Caribbean Lowland Tribes: The Mosquito, Sumo, Paya, and Jicaque. In Handbook of South American Indians, vol.4, 219-229, Julian H. Steward, ed., Smithsonian Institution Bureau of American Ethnology, Bulletin 143, 219-229, Washington.

Kirchoff, Paul

1948b The Guayupe and Sae. In Handbook of South American Indians, vol.4, 385-391, Julian H. Steward, ed., Smithsonian Institution Bureau of American Ethnology, Bulletin 143.

Kroeber, A.L.

1930 Cultural Relations between North and South America.

Proceedings of the XXIII International Congress of Americanists, New York, 5-22.

Lange, Frederick William

1971a Culture History of the Sapoa River Valley, Costa Rica. Doctoral dissertation, University of Wisconsin, Anthropology Dept, University Microfilms International, Ann Arbor, Michigan.

1971b Northwestern Costa Rica: Pre-Columbian Circum-Caribbean Affiliations. Folk, vol.13:43-64, Kobenhavn.

1971c Culture History of the Sapoa River Valley, Costa Rica. Logan Museum of Anthropology, Occasional Papers No.4, Beloit, Wisconsin, Beloit College.

1976 Bahias y Valles de la Costa de Guanacaste. In Vinculos, vol.3:45-66. Museo Nacional de Costa Rica, San Jose.

1978 Coastal Settlement in Northwestern Costa Rica. In Prehistoric Coastal Adaptations: The Economy and Ecology of Maritime Middle America. Barbara L. Stark and Barbara Voorhies, eds., 101-119, Academic Press, New York.

1979a Theoretical and Descriptive Aspects of Frontier Studies. Latin American Research Review 14:221-227.

1979b La Administracion de Los Recursos Culturales en la Bahia de Culebra (Un informe sobre la prospeccion realizada dentro de la zona de impacto del desarrollo Turistico Bahia de Culebra. Manuscript on file Departamento de Antropologia e Historia Museo Nacional de Costa Rica, San Jose.

1980 The Formative Zoned Bichrome Period in Northwestern Costa Rica (800 B.C. to A.D. 500), Based on Excavations at the Vidor Site, Bay of Culebra. Vinculos 6(1-2):33-42. Museo Nacional de Costa Rica, San Jose.

- 1984 The Greater Nicoya Archaeological Subarea. In The Archaeology of Lower Central America. Lange and Stone, eds., University of New Mexico Press, Albuquerque. 165-194.
- 1986 Introduction to the Guanacaste/San Carlos Corridor Project. In Prehistoric Settlement Patterns in Costa Rica, Journal of the Steward Anthropological Society Society, Frederick W. Lange and Lynette Norr, eds., vol.14, nos.1 and 2, 1982-83:93-96, Urbana.
- Lange, Frederick W. and Suzanne Abel-Vidor
 1980 Investigaciones Arqueologicas en la Zona de Bahia Culebra, Costa Rica (1973-1979). In Vinculos, vol.6, no. 1-2:5-7. San Jose
- Lange, Frederick W., Richard M. and Peter R. Ryder
 1980 La Administracion de los recursos culturales en Bahia Culebra. Vinculos, vol.6, nos.1-2:9-32, Museo Nacional de Costa Rica, San Jose
- .
- Lange, Frederick W. and Suzanne Abel-Vidor, Claude F. Baudez, Ronald L. Bishop, Winifred Creamer, Jane S. Day, Juan Vicente Guerrero M., Paul F. Healy, Silvia Salgado G. Robert Stroessner, Alice Tillet
 1984 New Approaches to Greater Nicoya Ceramics. In Recent Developments in Isthmian Archaeology: Advances in the Prehistory of Lower Central America. Proceedings of the 44th. International Congress of Americanists, BAR International Series 212. Frederick W. Lange, ed. 199-214.
- Lange, Frederick W. and Ronald Bishop
 1988 Abstraction and Jade Exchange in Southern Mesoamerica and Lower Central America. In Costa Rican Art and Archaeology, Frederick W. Lange, ed.. University of Colorado, Boulder, 65-88.
- Lathrap, Donald W.
 1975 Ancient Ecuador Culture, Clay and Creativity 3000-300 B.C.. Field Museum of Natural History. Chicago.

Lawrence, John W.

- 1981 Mesetas y Cementerio de la Ladera Norte. Manuscript on file, Depto. de Antropologia y Historia, Museo Nacional de Costa Rica, San Jose

Lawrence, John W.

- 1989 A Report on the Application of Palynological Data to the Archaeology of Nacascolo, Bahia Culebra, Costa Rica. Masters thesis, Department of Anthropology, University of Pennsylvania.

Lawrence, John W. and Ellen T. Hardy

- 1982 Excavation of an Early Polychrome Period Tomb at Nacascolo. Manuscript on file Departamento de Historia y Antropologia, Museo Nacional de Costa Rica.

Le Barre, Weston

- 1970 Old and New World Narcotics: A Statistical Question and an Ethnological Reply. Economic Botany, vol.24:368-373.

Lee, Jr., Thomas A.

- 1969 The Artifacts of Chiapa de Corzo, Chiapas, Mexico. Papers of the New World Archaeological Foundation, no.26, Brigham Young University, Provo, Utah.

Lothrop, Samuel Kirkland.

- 1926 Pottery of Costa Rica and Nicaragua. Museum of the American Indian, Heye Foundation, New York, 2 vols.

Lothrop, Samuel Kirkland

- 1940 South America as Seen from Middle America. In The Maya and Their Neighbors, 417-429, New York.

Lothrop, S. K.

- 1954 Suicide, Sacrifice and Mutilations in Burials at Venado Beach, Panama. American Antiquity:226-234.

Love, Doris Holly

- 1986 Midden Analysis: The Validity of Column Sampling in Defining Prehistoric Coastal Adaptations. Doctoral dissertation, Archaeology Program,

Defining Prehistoric Coastal Adaptations.
Doctoral dissertation, Archaeology Program,
University of California, Los Angeles.

Maddox, John Lee

1923 The Medicine Man: A Sociological Study of the Character and Evolution of Shamanism. The Macmillan Company, New York.

Marcus, Joyce

1982 The Plant World of the Sixteenth-Century Lowland Maya. In Maya Subsistence Studies in Memory of Dennis E. Puleston. Academic Press, New York, 239-273.

McGimsey, Charles R. III

1959 A Survey of Known Burial Practices in Panama. Actas del XXXIII Congreso Internacional de Americanistas, Tomo 1:347-356, San Jose, Costa Rica.

McGimsey, Charles R. III, Michael B. Collins, and Thomas W. McKern

1988 Cerro Mangote and Its Population. Journal of the Steward Anthropological Society vol.16, nos. 1 and 2:125-157.

Meighan, Clement W.

1972 Archaeology of the Morett Site, Colima. University of California Press.

Meighan, Clement W.

1976 The Archaeology of Amapa, Nayarit. Monumenta Archaeologica Vol. 2, The Institute of Archaeology, University of California, Los Angeles.

1979 La Espanola: A Rock Art Site in Northern, Costa Rica. Preliminary report, Ms on file, Museo Nacional de Costa Rica, San Jose.

1984 Archaeology: Science or Sacrilege? In Ethics and Values in Archaeology. Ernestene L. Green, ed. The Free Press, New York, 208-223.

- Melendez, D. Carlos
 1962 Los Viajes de Cockburn y Lievre por Costa Rica.
 Notes on and Spanish translation of original
 english editions. Editorial Costa Rica, San Jose.
- Minelli, Laura Laurencich
 1980 La Caverna Nicoa: Un Cenote Sagrado en Costa Rica,
 Informe Preliminar. Informe Semestral, Ministerio
 de Obras y Transportes, Instituto Geografico
 Nacional:56-70.
- Moreau, Jean-Francois
 1980 A Report on the Hunter-Robinson and Sardinal Sites.
Vinculos, vol.6, nos.1-2:107-124..
- Moreau, Jean-Francois
 1984 L'Adaptation Maritime Prehistorique Au Sitio Vidor,
 Costa Rica. Ph.D. dissertation, University of
 Montreal.
- Moser, Christopher L.
 1973 Human Decapitation in Ancient Mesoamerica. Studies
 in Pre-Columbian Art and Archaeology, no.11.
 Dumbarton Oaks, Washington D.C..
- Mueller, Marilyn
 1984 Laguna de Arenal Shoreline Survey. Vinculos
 10(1-1):61-73, Museo Nacional, San Jose, Costa
 Rica.
- Nicholson, H. B.
 1972 The Cult of Xipe Totec in Mesoamerica. In Religion
 en Mesoamerica. Sociedad Mexicana de Antropologia,
 Mexico City, 213-218.
- Nordenskiold, Erland
 1930 Modifications in Indian Cultures through Inventions
 and Loans. Comparative Ethnological Studies, vol.8
 Goteborg.
- Norr, Lynette
 1986 Archaeological Site Survey and Burial Mound
 Excavations in the Rio-Naranjo-Bijagua Valley. In

Prehistoric Settlement Patterns in Costa Rica,
Journal of the Steward Anthropological Society,
vol.14, nos. 1-2:135-156, Frederick W. Lange and
Lynette Norr, eds., Urbana.

Norweb, Albert H

1961 The Archaeology of the Greater Nicoya Subarea.
Ms on file Museo Nacional de Costa Rica, San Jose.

Norweb, Albert H

1964 Ceramic Stratigraphy in Southwestern, Nicaragua.
Actas, 35th International Congress of Americanists,
vol. 1:551-561.

Piedra G. Victor, y Elena Hardy

1980 Informe Sobre El Prospeccion del Sitio Nacascolo.
Paper on file Depto. de Antropologia y Historia,
Museo Nacional de Costa Rica.

O'Shea, John M.

1984 Mortuary Variability An Archaeological
Investigation. Academic Press, Inc.. Orlando.

Oviedo y Valdes, Gonzalo Fernando

1976 Nicaragua en los Cronistas de Indias: Oviedo.
Introduccion y Notas Eduardo Perez Valle.
Coleccion Cultural, Banco de America, Serie
Cronistas No.3. Nicaragua.

Pallant, Eric

1981 Shell Middens and Environmental Change in
Guanacaste, Costa Rica. Paper on file Depto. de
Antropologia y Historia, Museo Nacional de Costa
Rica.

Paulsen, Alison

1977 Patterns of Maritime Trade between South Coastal
Ecuador and Western Mesoamerica. In The Sea in the
Precolumbian World. Elizabeth P. Bensen, ed.,
Dumbarton Oaks, Washington, 141-166.

Pearson, G.W. and M. Stuiver

1986 High Precision Calibration of the 14C A.D.500-

- Pearson, G.W. and M. Stuiver
 1986 High Precision Calibration of the 14C A.D.500-2500B.C. Calibration Volume Radiocarbon, no. 28:839-862.
- Peebles, Christopher
 1974 Moundville: The Organization of a Prehistoric Community and Culture. Ph.D. dissertation, University of California, Santa Barbara.
- Perez Valle, Eduardo
 1976 Introduccion y Notas. In Nicaragua en los Cronistas de Indias: Oviedo. Coleccion Cultural, Banco de America, Serie Cronistas No.3. Nicaragua.
- Porter, Muriel Noe
 1956 Excavations at Chupicuaro, Guanajuato, Mexico, Transactions of the American Philosophical Society, vol. 46, part 5, Philadelphia.
- Puleston, Dennis E.
 1982 The Role of Ramon in Maya Subsistence. In Maya Subsistence Studies in Memory of Dennis E. Puleston. Kent V. Flannery, ed., Academic Press, 353-366, New York.
- Ranere, A. J. and E. J. Rosenthal
 1980 Lithic Assemblages from Aguacate Peninsula. In Adaptive Radiations in Prehistoric Panama, Peabody Museum Monographs, Number 5, 467-484, Olga F. Linares and Anthony J. Ranere, editors. Harvard University Press, Cambridge.
- Rechtman, Robert
 1980 Operation 8(A,B,C,D,E), 8/8/80-9/10/80, fieldnotes of the first season. Paper on file Museo Nacional de Costa Rica, San Jose.
- Reichel-Dolmatoff, G.
 1965 Columbia. Ancient People and Places series: Thames and Hudson, London.
- Reichel-Dolmatoff, Gerardo

Thames and Hudson, London.

Reichel-Dolmatoff, Gerardo

- 1972 The Feline Motif in Prehistoric San Agustin Sculpture. In The Cult of the Feline, Elizabeth P. Benson, ed., pages, Dumbarton Oaks, Washington.

Reichel-Dolmatoff, Gerardo

- 1974 Funerary Customs and Religious Symbolism Among the Kogi. In Native South Americans: Ethnology of the Least-Known Continent. Patricia J. Lyon, editor, Little, Brown and Co., Boston/Toronto, 288-301.

Reichel-Dolmatoff, G.

- 1988 Funeral Rites and Shamanism. In Goldwork and Shamanism: An Iconographic Study of the Gold Museum, Colina, Medellin, 33-38.

Richardson, Francis B.

- 1940 Non-Maya Monumental sculpture in Central America. In The Maya and Their Neighbors. D. Appleton-Century Company, Inc., Second Edition, 1962, 395-416.

Rouse, Irving

- 1948a The Arawak. In Handbook of South American Indians, vol.4:507-546, Smithsonian Institution Bureau of American Ethnology, Bulletin 43, Julian H. Steward, ed., Washington.

- 1948b The Carib. In Handbook of South American Indians, vol.4:547-565, Smithsonian Institution Bureau of American Ethnology, Bulletin 43, Julian H. Steward, ed., Washington.

- 1962 The Intermediate Area, Amazonia, and the Caribbean Area. In Courses Toward Urban Life, Braidwood and Willey, eds. Werner-Gren Foundation for Anthropological Research, Inc. Viking Publications in Anthropology, no.32:34-59.

Ruz L. Alberto

- 1965 Tombs and Funerary Practices in the Maya Lowlands.

In Handbook of Middle American Indians, vol.2, part 1:441-461, Wauchope, ed. Middle American Research Institute, Tulane University, University of Texas Press, Austin.

Ryden, Stig

1944 Contributions to the Archaeology of the Rio Loa Region. Goteborg.

Ryder, Peter

1978 Codesa: La Fabrica de Cemento en Colorado, Guanacaste: Una Prospeccion de Sitios Precolumbinos. Manuscript #1402, 3 pages, on file in Biblioteca Antropologica y Historia, Museo Nacional de Costa Rica, San Jose.

Ryder, Peter Raymond

1983 The Carved Metates of Greater Nicoya. Unpublished Masters thesis, University of Pennsylvania.

Ryder, Peter

1986 Hacienda Mojica. In, Prehistoric Settlement Patterns in Costa Rica, Journal of the Steward Anthropological Society, Frederick W. Lange and Lynette Norr eds., vol.14, nos.1 and 2, 1982-83:105-120, Urbana, Illinois.

Saxe, Arthur

1970 Social Dimensions of Mortuary Practices. Ph.D. dissertation, University of Michigan, University Microfilms Inc., Ann Arbor, Michigan.

Sackett, James R.

1986 Personal communication.

Sauer, Carl O.

1952 Agricultural Origins and Dispersals. The American Geographical Society, New York.

Seler, Herr ed.

1886 Notes on American Ethnology. In The American Antiquarian and Oriental Journal. Rev. Stephan D. Peet, editor, vol.VIII, no.2, March.

Service, Elman R

- 1962 Primate Social Organization. Random House, New York.

Sheets, Payson D.

- 1984 Summary and Conclusions. In Investigaciones Arqueologicas en la Cordillera de Tilaran Costa Rica 1984. Vinculos, vol.10, no.1-2:207-223. Museo Nacional de Costa Rica, San Jose.

Sheets, Payson D.

- 1987 The Hoosiers of Middle America. Paper presented at Dumbarton Oaks Conference on Wealth and Hierarchy in the Intermediate Area. October, Washington.

Snarskis, Michael J.

- 1981 The Archaeology of Costa Rica. In Between Continents Between Seas: Precolumbian Art of Costa Rica. Detroit Museum, Elizabeth Benson, ed., 15-81.

- 1984 Central America: The Lower Caribbean. In The Archaeology of Lower Central America. Frederick W. Lange and Doris Z. Stone, eds., 195-232, University of New Mexico Press, Albuquerque.

Snarskis, Michael J.

- 1985 Boletin 7-8, Asociacion Arqueologica de Costa Rica, Snarskis, ed. San Jose.

Spinden, Herbert J.

- 1925 The Chorotegen Culture Area. In XX Congreso Internacional des Americanistes, 529-545, Goteborg.

Sprague, Roderick

- 1968 A Suggested Terminology and Classification for Burial Description. American Antiquity 33:479-485.

Steinbock, R. Ted

- 1976 Paleopathological Diagnosis and Interpretation. Charles C. Thomas Publisher, Illinois.

Stevens, R. L.

- 1964 The Soils of Middle America and Their Relationships to Indian Peoples and Cultures. In Handbook of Middle American Indians. Robert Wauchope, ed., 1:265-315. University of Texas Press, Austin.

Steward, Julian H

- 1948 The Circum-Caribbean Tribes. In Handbook of South American Indians, vol.4:41-41. Julian H. Steward, ed. Smithsonian Institution Bureau of American Ethnology, Bulletin 143, Washington.

Steward, Julian H.

- 1955 Theory of Culture Change: The Methodology of Multilineal Evolution. Urbana.

Stone, Doris

- 1945 La posicion de los Chorotegas en la arqueologia Centroamericana. In Revista Mexicana de Estudios Antropologicos. Tomo septimo:121-131, Mexico.
- 1948 The Basic Cultures of Central America. In Handbook of South American Indians, vol.4 The Circum-Caribbean Tribes, Julian H. Steward, ed., 169-193.
- 1958 Introduction to the Archaeology of Costa Rica. Museo Nacional, San Jose, Costa Rica.
- 1963 Culture Traits and their Significance. American Antiquity, vol.28, no.3:339-359.
- 1966a Algunas Culturas y Migraciones a Traves de Ciertos Objetos Arqueologicos de la Provincia de Guanacaste, Costa Rica. Boletin no.23 de la Asociacion Amigos del Museo, 9 de agosto, 1966:1-12, Museo Nacional de Costa Rica, San Jose.
- 1966b Synthesis of Lower Central American Ethnology. In Handbook of Middle American Indians, vol.4:209-233, Archaeological Frontiers and External Connections. University of Texas Press, Austin.

- 1967 Imagenes de Culto Vistas a Traves de Ciertos Ejemplares de Ceramica Procedente de la Peninsula de Nicoya, Costa Rica. Boletin no.32 de la Asociacion Amigos del Museo, agosto, Museo Nacional de Costa Rica, San Jose, 1-12.
- #1439 An Interpretation of Furnishings from a Grave at Nacascolo, Province of Guanacaste, Costa Rica. Manuscript #1439, 6 pages, unmarked year, on file Biblioteca Antropologica y Historia, Museo Nacional de Costa Rica, San Jose.
- 1972 Pre-columbian Man Finds in Central America. Peabody Museum of Archaeology and Ethnology, Harvard University, Cambridge, Mass.
- 1977 Precolumbian Man in Costa Rica. Peabody Museum of Archaeology and Ethnology, Harvard University, Cambridge, Mass.
- Stone, Doris
 1979 A Burial of the Late Polychrome in the Province of Guanacaste, Costa Rica. In Estudios Americanistas II Homenaje a H. Trimbom. Manuscript #3718, 253-257, on file Biblioteca Antropologica y Historia, Museo Nacional de Costa Rica, San Jose.
- Strong, Wm. Duncan
 1948 The Archaeology of Honduras. In Handbook of South American Indians, vol.4, The Circum-Caribbean Tribes, Julian H. Steward, ed., 71-120 .
- Strong, Wm. Duncan
 1948 The Archaeology of Costa Rica and Nicaragua. In Handbook of South American Indians, vol.4 The Circum-Caribbean Tribes, Julian H. Steward, ed., 121-142.
- Stuiver M. and G.W. Pearson
 1986 High Precision Calibration of the 14C A.D. 1950-500 B.C.. In Calibration Volume Radiocarbon, no.28: 839-862.

- Swauger, James L. and William J. Mayer-Oakes
 1952 A Fluted Point from Costa Rica. In American Antiquity 17:264-65.
- Sweeney, Jeanne W.
 1975 Guanacaste, Costa Rica: An Analysis of Precolumbian Ceramics from the Northwest Coast. Doctoral dissertation University of Pennsylvania, University Microfilms International, Ann Arbor, Michigan, two volumes.
- Sweeney, Jeanne W.
 1976 Ceramic Analysis from 3 Sites in Northwest Coastal Guanacaste. In Vinculos, vol. 2, no. 1:37-44. Museo Nacional de Costa Rica, San Jose.
- Tainter, Joseph Anthony
 1975 The Archaeological Study of Social Change: Woodland Systems in West-Central Illinois. Ph. D. dissertation, Dept. of Anthropology, Northwestern University.
- Termer, Franz
 1955 El valor historico, geografico y etnologico de los apuntes de John Cockburn sobre Centroamerica en el siglo XVIII. Translated from German to Spanish by Dr. Ernesto J. Wender and revised by Jorge A. Lines. In Los Viajes de Cockburn y Lievre. Notes by D. Carlos Melendez, 56-93. Editorial Costa Rica, 1962. .
- Thompson, J. Eric S.
 1970 Maya History and Religion. University of Oklahoma Press. First paperback printing, 1990.
- Tillett, Alice C.
 1988 Sacred Symbols of Life and Death in Northern Costa Rica. In Costa Rican Art and Archaeology, essays in Honor of Frederick R. Meyer. Frederick W. Lange, ed., 47-63, University of Colorado, Boulder.
- Treganza A. E. and S. F. Cook
 1948 The Quantitative Investigation of Aboriginal Sites:

- Trotter, Mildred and Goldine C. Gleser
 1958 A Re-evaluation of Estimation of Stature Based on Measurements of Stature Taken During Life and of Long Bones After Death. American Journal of Physical Anthropology, 16:79-123.
- Turner, Christy
 1986 What is Lost With Skeletal Reburial? I. Adaptation. In Quarterly Review of Archaeology, vol.7, no.2, March.
- Ubelaker, Douglas H.
 1978 Human Skeletal Remains Excavation, Analysis and Interpretation. Aldine Publishing Company Inc. Chicago, Illinois.
- Ubelaker, Douglas H. and Lauryn Guttenplan Grant
 1989 Human Skeletal Remains: Preservation or Reburial? In Yearbook of Physical Anthropology, 32:249-287, Alan R. Liss, Inc.
- Ucko, Peter J.
 1969 Ethnography and Archaeological Interpretation of Funerary Remains. World Archaeology 1:262-281.
- Vaillant, George
 1934 The Archaeological Setting of the Playa de los Muertos Culture. Maya Research, vol.1, no.2:87-100.
- Vazquez Leiva, Ricardo
 1980 Consideraciones generales sobre una poblacion de hueso humanos encontrados en Bahia Culebra, Guanacaste. In V Centenario de Gonzalo Fernandez de Oviedo (1478)-Agosto-1978), Memoria del Congreso sobre el Mundo Centroamericano de su Tiempo, Nicoya, Costa Rica, America Central. Publicacion de la Comision Nacional Organizadora, 175-184.
- Vazquez Leiva, Ricardo
 1986 Excavaciones de muestrero en el Sitio Nacascolo un paseo adelante dentro del Proyesto Arqueologico Bahia Culebra, Costa Rica. In Prehistoric

- Vazquez Leiva, Ricardo
 1986 Excavaciones de muestrero en el Sitio Nacascolo un paseo adelante dentro del Proyecto Arqueologico Bahia Culebra, Costa Rica. In Prehistoric Settlement Pattern in Costa Rica. Journal of the Steward Anthropological Society, vol.14, nos. 1 and 2:67-92, 1982-83, Frederick W. Lange and Lynette Norr, eds., Urbana.
- Verano, John W.
 1982 Human Skeletal Remains from the Nacascolo Beach Cemetery. Manuscript on file Institute of Archaeology, University of California, Los Angeles and in Museo Nacional de Costa Rica.
- Vincenzi, Moises
 1936 Geografia de Costa Rica. Imprenta Nacional, San Jose, Costa Rica
- Vivo-Escoto, Jorge A.
 1964 Weather and Climate of Mexico and Central America. In Handbook of Middle American Indians, 1:187-215, Robert Wauchope, ed., University of Texas Press, Austin.
- Voorhies, Barbara
 1978 Previous Research on Nearshore Coastal Adaptations in Middle America. In Prehistoric Coastal Adaptations The Economy and Ecology of Maritime Middle America, Barbara L. Stark and Barbara Voorhies, eds., Academic Press, New York.
- Wagner, Phillip
 1958 Nicoya, A Cultural Geography. University of California Publications in Geography:12:4:195-250.
- Wallace, Henry and Richard Accola
 1980 Investigaciones Arqueologicas Preliminares de Nacascolo, Bahia Culebra, Costa Rica. In Vinculos, vol.6, nos.1-2:51-65. Museo Nacional de Costa Rica, San Jose.
- Wassen, S. Henry
 1965 The Use of Some Specific Kinds of South American

- 1963 The Use of Parica, an Ethnological and Pharmacological Review. Ethnos I:5-45. The Ethnological Museum of Sweden, Stockholm.
- Weaver David and Ricardo Vazquez L.
 1980 Un Analisis Osteologico para el Reconocimiento de las Condiciones de Vida en Sitio Vidor. Vinculos, vol.6, nos.1-2:97-105. Museo nacional de Costa Rica, San Jose.
- West, Richard L.
 1964 The natural Regions of Middle America. Handbook of Middle American Indians, 1:363-383. Robert Wauchope and Richard West, eds.. University of Texas Press, Austin.
- Wilbert, Johannes
 1986 Personal communication
- Wilbert, Johannes
 1987 Tobacco and Shamanism in South America. Yale University Press.
- Willey, G. R.
 1959 The "Intermediate Area" of Nuclear America: Its Prehistoric Relationships to Middle America and Peru. Actas del 33rd. Congreso Internacional de Americanistas vol.1:184-194, San Jose.
- Wing, Elizabeth S. and Antoinette B. Brown
 1979 Paleonutrition. Academic Press, New York.
- Wing, George
 External Contacts in Bahia Culebra from Private Collections. ACM paper #23, on file Depto. de Historia y Antropologia, Museo Nacional de Costa Rica, San Jose.
- Winter, Marcus C.
 1976 The Archaeological Household Cluster in the Valley of Oaxaca. In The Early Mesoamerican Village, Kent V. Flannery, ed., 25-31. Academic Press, New York.

Wire, Marcia Van V.

1972 Funerary Beliefs and Practices in Prehispanic
Western Mesoamerica. Doctoral dissertation,
Anthropology Department, University of California,
Los Angeles. University Microfilms International,
Ann Arbor, Michigan.

APPENDIX I

NACASCOLO BEACH CEMETERY (OP.8A-M) BURIAL DESCRIPTIONS AND SKELETAL ANALYSES

Burial 1: Primary individual in medium condition found 143 cm. below datum. Burial disturbed by interment of Burial 25 which cut Burial 1 in half, leaving only the upper torso. Individual placed on its back but whether in flexed or extended position is impossible to determine. Cranium rests on left side, head towards the north, orientated 340 degrees. The right arm tightly flexed, hand raised toward the head. The left arm appears to have been placed in the same position as the right however, this is uncertain for the inferior part of this arm is missing; this is most likely due to the disturbance caused by the interment of Burial 25. Burial 1 is part of Group Burial 1, comprised of Burials 2 (child), 25 (old adult male), and 29 (infant).

Skeletal analysis: Young adult, sex unknown.

Associated artifacts: None, probably due to intrusive burials.

Chronologic assessment: Older than Burial 25 whose grave offerings consist of Early Polychrome Period ceramics.

Burial 2: Primary individual encountered in medium condition at 147 cm. below datum. Placed on the back in semiflexed position, head towards north, orientation 10 degrees, arm position uncertain. Part of Group Burial 1 comprised of Burials 1, 25, and 29. Burial 1 is 15 cm. to the east, Burial 29 rests 20 cm. to the west. Burial 2 is somewhat disturbed; the body is twisted; the inferior long bones run 150 degrees while the thorax and cranium run 200 degrees. The inferior long bones rest in a level position with the superior part of the body slightly inclined from the pelvis to the cranium, possibly in relation to curvature of burial pit. Artifacts 57 and 15 placed along the right side of body, Artifact 14 caps Artifact 16, both are placed above the head to the northwest; Artifact 56 placed upside down on top of chest. Additional grave offerings Artifacts 10 and 15 found in burial fill.

Skeletal analysis: Child, about 2 years, sex undetermined.

Associated artifacts:

Art. 56, down, 145 cm. tripod bowl placed on chest, Juanilla Red on Beige.

Art. 57 up, 149 cm. olla, Los Hermanos Beige

Art. 15 up, 123 cm. olla, Los Hermanos Beige

Art. 14 up, 124 cm. olla, Juanilla Red on Beige.

Art. 16 up, 125 cm. olla, Congo Punctate, effigy applique, head broken off, can't determine what it is, found inside Art. 14.

Art. 10 up, 90 cm. in burial fill, Red Ware
Chronologic assessment: end of Zoned Bichrome Period.

Burial 3: Individual found at 124 cm.. Placed on back in extended position. Oriented 276 degrees, head toward west, looks south, rests on right temporal. Arms are extended along the sides. No hands or feet present, this is most likely due to deterioration. Found together, but not articulated, were one deer long bone and 2 human bones, including a cranium, which was placed at the right foot of Burial 3. This cranium was most likely severed from Burial 4 during the interment of Burial 3, and then repositioned; Burial 4 lies underneath Burial 3. Burial 3 is in overall poor condition. A large rock was placed on top of abdomen area. Artifact 22 placed to the north side of left humerus. This vessel may have been originally interred with Burial 4 but was disturbed (as was the cranium) and relocated with Burial 3.

Skeletal analysis: Adolescent approximately 18 years, female.

Associated artifacts: Art.22 up, 119 cm. placed to north of left humerus, Tola Trichrome (Norweb 1964) no dots? tripod bowl. 4 spire-lopped Olivella beads placed around cranium 4.

Chronologic assessment: Extended burial position suggests Middle Polychrome Period, however, Tola Trichrome is considered a horizon marker of the Early Polychrome Period and often found towards end of Zoned Bichrome Period. It is possible this vessel was originally interred with Burial 4 and later disturbed by and reburied with Burial 3. I base this on the flexed position of Burial 4, typical of Zoned Bichrome and Early Polychrome Periods burial practices, and Burial 3's extended position, typical of Middle Polychrome Period burial practices. While the flexed and extended burial positions most likely overlap temporally, I don't think this is evidenced here; due to the intrusive nature of Burial 3, it is likely the Tola vessel was originally placed with Burial 4.

Burial 4: Individual found at 142 cm. below datum. Placed on back in tightly flexed position. Orientation 270 degrees. Cranium missing most likely due to subsequent interment of Burial 3. Arms flexed across abdomen left over right, passing underneath tightly flexed legs. Feet turned inward underneath pelvis.

Skeletal analysis: Middle-adult, sex undetermined.

Associated artifacts: None, possibly due to disturbance caused by interment of Burial 3.

Chronologic assessment: Based on burial position (and Tola vessel), late Zoned Bichrome-Early Polychrome Period.

Burial 5: Primary individual found at 155cm. below datum. Placed on back in tightly flexed position. Head to east, orientation 90 degrees, faces west, head slightly compressed to chest. Left arm tightly flexed and rests on chest above the left leg, left hand flexed and rests over heart. Right arm flexed and rests below the right femur, tibia and fibula; right hand rests on the pelvis. Feet flexed inward and cover the coccyx. Overall osseous remains in very good condition. Artifact 67, a large, smashed rimless monochrome vessel, was placed to the east above the right side of cranium. Artifact 72 placed to the northeast of right leg.

Skeletal analysis: Male, young adult

Associated artifacts:

Art. 67 139 cm. large rimless vessel Los Hermanos Beige

Art. 72 up, 132 cm. olla Los Hermanos Beige

Chronologic assessment: End of Zoned Bichrome - Early Polychrome Period.

Burial 6: Bone scatter found at 114 cm. below datum near Burials 26, 21, and 20. Burial very disturbed. Consists of 4 long bone fragments, dispersed irregularly, and 4 teeth. Position of body and orientation impossible to determine. Three ceramic vessels found among the bone scatter. Volcanic stones were placed on top and to the sides of this individual.

Skeletal analysis: Impossible to determine age and sex of this individual.

Associated artifacts:

Art 30 up, 105 cm. next to Art 31, monochrome olla no rim, type unknown.

Art 31 up, 106 cm. next to Art 30, olla with applique face on both sides type Apompua Modelled.

Art 32 up, 104 cm. Cabuyal Polychrome olla.

Chronologic assessment: Lange et al (1984) list Apompua Modelled at end of Zoned Bichrome Period and Healy (1980) indicates this type predominantly Zoned Bichrome in Rivas; however, the type is found in Middle Polychrome deposits at Cahuite Escondido (Sweeney 1975:273). Burial 6 considered Middle Polychrome Period.

Burial 7: Individual found at 118 cm. below datum in very poor condition. Placed in flexed position legs to left

side. Oriented 20 degrees, head rests on right temporal. Right arm tightly flexed over the thorax in such a manner that the hand rests below the right part of cranium. Only parts of left arm observed, appears to have been flexed, passes underneath the left arm and over the legs. Artifact 33 placed directly west of the cranium.
Skeletal analysis: Adult, sex unknown
Associated artifacts: Art.33 up, 98 cm. olla LHB?
-another vessel found with Burial 7 skull next to vessel.
Chronologic assessment: Zoned Bichrome-Early Polychrome Period.

Burial 8: One isolated long bone fragment found at 112 cm. near Burials 11 and 10. Associated with some turtle bones. Poor preservation.
Skeletal analysis: Age and sex undetermined.
Associated artifacts: Possibly associated with bowl Art 34, LHB, down, 101cm
-turtle bone
Chronologic assessment: end of Zoned Bichrome to Early Polychrome period.

Burial 9: Fragmentary remains of this individual found at 108 cm., they include: cranial fragments, one inferior long bone, one phalange, and some superior long bones fragments. The inferior long bone lies on top of the thorax of Burial 11. (Burials 8,9,10, and 11 in proximity). The cranium rests to the east of this long bone with Artifact 35 8 cm. to the south. The body was placed in an extended position based on the extension of the bones but it is impossible to define exactly how it was placed. This burial may have disturbed Burial 11; Burial 11 cranium removed and its fragments reinterred approximately 50 cm. to the north of Burial 11.
Skeletal analysis: unable to determine age and sex.
Associated artifacts: Art.35 up, 93 cm. Mora Polychrome
Chronologic assessment: Panama Phase, Middle Polychrome Period.

Burial 10: Consists of four long bone fragments including a possible tibia found at 107 cm. Oriented 50 degrees east, although exact position undetermined. Burial in very poor condition. Burial 11 lies 17 cm. to the north.
Skeletal analysis: age and sex undetermined.
Associated artifacts: No associated artifacts.
Chronologic assessment: unable to determine.

Burial 11: Primary individual found at 120 cm. oriented due North. Placed on back in flexed position, legs to the left. Left arm flexed across abdomen and rest below right elbow. Right arm tightly flexed with hand resting on heart. Disturbed by Burial 9 whose interment severed the cranium of Burial 11; a long bone belonging to Burial 9 rests across the thorax of Burial 11; cranial fragments believed to be from Burial 11 were found approximately 40 cm. to the north.

Skeletal analysis: Middle adult, female? Heavy tooth loss possibly due to disturbance.

Associated artifacts:

Art.11 up, 105 cm. Puerto Black on Red tripod bowl with central grater type punctations.

Art. 95, modified siltstone rasp, similar to one found with Burial 34 and Feature 1.

-1 small bone found 4 cm. to west of Art. 11.

-3 coral beads

-3 bone groups

Chronologic assessment: Puerto Black on Red indicative of Mata de Uva Phase of Zoned Bichrome Period.

Burial 12: "a few long bones left in wall"

Burial will not be considered in burial count, however, Artifacts 37 and 38 were found in association and excavated.

Associated artifacts:

Art.37, down, 110cm. "large olla" with one Palmares type sherd.

Art.38, 133cm. spindle whorl, type Mora Polychrome.

Chronologic assessment: Palmares and Mora both Panama Phase of Middle Polychrome Period.

Burials 13 a and b: Consists of the fragmentary remains of two infants found at a depth of 163 cm. slightly east of the remains of Burials 3 and 4. 13a was placed in semiflexed position on back. Oriented 40 degrees west of north, head to northwest resting on occipital. 13b consists of long bones and cranial fragments. It is not possible to ascertain if these bones are part of the same individual, or if they represent another person. Based on location they were collected as two separate individuals.

Skeletal analysis: the remains of one possibly two infants, sex undetermined.

Associated artifacts:

Art.68, down, 150 cm. caps Art 69, Red Ware with strap supports Mansion Red?.

Art.69, up, 151 cm. contains Art.68 Red Ware, type Piches Red (Baudez 1967), possible turtle shell (boat?) effigy.

70 up, 151 cm. Tola Trichrome (Norweb 1962) bowl with strips, to the north and leans on Artifacts 68 and 69. 24 side, 106 cm. Juanilla Red on Beige tripod bowl. NOTE: Art.24 Burial 4 found near skull @ 4cm. away a spire-lopped olivella found similar to one found with Art.13. Clearing the area 3 more shells with similar holes were found. Possibly associated with additional vessels 26, 27, 28, 29.

Chronologic assessment: End of Zoned Bichrome - Early Polychrome Period.

Burial 14: Individual found at 135 cm. placed on back but exact position impossible to ascertain due to pit which cuts burial. Oriented 45, head rests on right temporal. Left arm extended. Right arm cut by pit. This burial in proximity to Feature 1; it is possible that this burial was disturbed by workers laying a PVC pipe in the early 1960's, or perhaps disturbed in Precolumbian times during interment of Feature 1. See discussion of Feature 1.

Skeletal analysis: Young adult, sex?

No associated artifacts.

Chronologic assessment: based on association with Feature and Burial 34, no later than Early Polychrome Period.

Burial 15: 8A/C. Consists of three unidentifiable bone fragments found at 120 cm. below datum near a cluster of ceramic vessels (Artifacts 39-45), and one spire-lopped olivella. This artifact cluster was found underneath the hearth of Feature 1, which is actually part of the tomb for Burial 34. It is possible Burial 15 was disinterred during the interment of Burial 34; no grave offerings should be attributed to Burial 15 but to Burial 34.

Chronologic assessment: end of Zoned Bichrome-Early Polychrome Period.

Burial 16: Individual found at 115cm., 8e. Appears to have been placed on right side in semiflexed position. Oriented 80 degrees, head rests on right parietal, faces bay. Inclusive and associated with Burial 7. Associated with Art.46, a vessel placed to the south of the remains; this vessel contains human hand bones. To the left side and 10 cm. over the ribs were found an accumulation of pot sherds supposedly from this same olla (not given an artifact number).

Skeletal analysis: Approximately 6 years old, sex undetermined.

Associated artifacts:

Art.46 up, 111 cm. Guinea Incised tripod support vessel,

rim and most of neck missing. Vessel contained hand bones.

Chronologic assessment: Guinea Incised indicative of Mata de Uva Phase, Zoned Bichrome Period.

Burial 17: 8C/E. Primary individual encountered at 163 cm. in good condition. Placed in a flexed position legs to the left side, more on the back than left side. Right arm semiextended with hand resting against pelvis and right femur. Left arm semiextended with hand resting below femur on the coccyx of pelvis.

Skeletal analysis: Young adult, female.

No associated artifacts.

Chronologic assessment: uncertain, based on burial position, end of Zoned Bichrome-Early Polychrome Period.

Burials 18 a and b: 8A/B. Consists of two crania, approximately the same age, and other parts of skeleton including tibia, ribs, and clavicle, which may have come from both individuals, or only one. It is impossible to say in what position the burials were placed, other than to say the crania laid on the occipitals. Encountered at 180 cm. Associated with Burial 30, an adult, sex undetermined.

Skeletal analysis:

Two infants @ 18 months, sex undetermined.

Associated artifacts:

Art 80 up, 167 cm. olla Los Hermanos Beige

Art 101 Miniature Espejo Black.

Chronologic assessment: Mata de Uva Phase of Zoned Bichrome Period.

Burial 19: 8B. Primary individual encountered at 143 cm., placed on back in flexed position, legs slightly to right. Head towards east. Poor preservation. Unknown arm position. Burial 5 adult male 60 cm. to the north.

Skeletal analysis: Infant, sex undetermined

Associated artifacts: 17 down, 100cm. black slip with white paint in incisions, caps Art. 19

19 up, 106cm. olla, Red ware, capped by Art 17.

Chronologic assessment: Zoned Bichrome Period.

Burial 20: 8E. Isolated skull fragments found at 95cm. Impossible to determine cranial placement. Located 320 degrees northwest of right arm of Burial 26.

Skeletal analysis:

Six cranial fragments of a young adult, sex undetermined.

Appears to have been placed to accompany Burial 26 (as was Burial 21).

No associated grave offerings.

Chronologic assessment: uncertain.

Burial 21: 8E. Isolated cranium in very poor condition. Depth? 55cm. from cranium of Burial 26, 35 degrees northwest.

Skeletal analysis: Teeth are most represented in this individual and are those of a child 5-9 years old.

No associated artifacts, burial appears to have been placed to accompany Burial 26.

Chronologic assessment: ?

Burial 22: 8E. Fragmentary remains of individual encountered at 111 cm. Very poor condition but able to ascertain individual placed on back in extended position. Head towards east. Art.66 a mano, and Art 71 a celt, placed over the right side of waist of this individual. Arm position undetermined. The head of Burial 23 rests over the pelvic area of Burial 22, left side.

Skeletal analysis: Young adult, sex undetermined.

Associated artifacts:

Art.66 basalt mano.

Art.71 stone celt.

Chronologic assessment: most likely Middle Polychrome Period.

Burial 23: 8E. Fragmentary remains of badly preserved and disturbed individual encountered at 120 cm. Placed in flexed position possibly to left side, head towards north. Left arm flexed across ribs. Right arm may also have been flexed across ribs. Disturbed by interment of Burial 22 whose left femur rests on top of the cranium of Burial 23. Rocks placed on top of Burial 23.

Skeletal analysis: Middle adult, sex undetermined.

Carious M3.

No associated artifacts.

Chronologic assessment: uncertain.

Burial 24: 8E. Consist of badly preserved remains of individual encountered at 130 cm. Appears to have been placed on back in flexed position. Most of the cranium, except for teeth and part of mandible, enter the east sidewall. Large rocks placed to the north.

Skeletal analysis: Child 5-9 years old, sex undetermined.

No associated artifacts but there may be isolated bone

groups!

Chronologic assessment: uncertain

Burial 25: Individual found at 168 cm., part of Group Burial 1 comprised of Burials 1, 2, and 29. Individual placed in on back in flexed, possibly tightly flexed position, legs slightly to the left, feet touch. Oriented 350 degrees, head toward north rests on occipital. Right arm flexed across abdomen and underneath legs. Left arm flexed with hand resting on thorax. A crab hole passes through the thorax of this individual which displaced vertebrae and ribs. The interment of this burial cut through the mid-section of Burial 29.

Skeletal analysis: Old adult, male, edentulous.

Associated artifacts: Large sherd placed above right shoulder at 139 cm. actually part of larger vessel Art. 64.

Art.64 up 147 cm. Piches effigy vessel (Lenguado)

Bothidae, caps Art.88

Art.1 up, 97 cm., olla LHB?

Art.2 up, 98 cm., olla LHB?

Art.4 up, 96 cm. small vessel found inside Art.1

Art.5 side, 94 cm. Piches Red effigy vessel (frigate bird) Fregatidae.

Art.6 face down 107cm. Miniature Piches Red anthromorph.

Art.7 up, 108cm. Tola tripod bowl.

Art.88 up, 151 cm. Guinea Incised, pedestal base vessel, with protruding figure (turtle) Testudinata, covered by Art.64.

Chronologic assessment: Guinea Incised and Tola both begin in the Mata de Uva Phase, Zoned Bichrome Period and continue into the Culebra Phase; at the earliest, Piches Red begins in Early Polychrome, and this burial should be considered of this period.

Burial 26: 8A/E. Individual encountered at 99cm., very poor condition. Placed on back in extended position. Oriented 90 degrees; head towards bay. The femurs of both legs are cut at the knee; the tibias, fibulas and feet are not present! Original field notes mention that intrusive activities that could have cut the legs were not observable. Left arm may have been flexed across the abdomen. Part of the center of the body is disturbed and missing. Burial 6 rests 40cm. to the south; and Burial 21 12 cm. to the northwest of the cranium of Burial 26; Burial 20 is 30cm. to the east of Burial 26.

Skeletal analysis: Middle adult, sex undetermined.

Associated artifacts: None

Chronologic assessment: uncertain.

Burial 27: 8E. Skull left in east sidewall, not included in burial count.

Burial 28: 8E. Individual encountered at 130 cm. placed on back in tightly flexed position. Right arm tightly flexed and raised towards head; right hand rest on sternum. Left arm flexed, crosses the midsection of body below the legs; left hand not found, but ceramic vessel (Art 46) located immediately to the northwest of this individual, contained hand bones. Oriented 30 degrees, looks west. This burial intrusive. Part of cranium, ribs, and femora of a sub-adult (Burial 16) are found in proximity; Burial 28 is 30cm. to the southeast (140 degrees).

Skeletal analysis: Female based on sciatic notch. Middle adult, female?, Missing left hand. Evidence of osteoarthritis.

Associated artifacts:

Art.75 up, 98cm. rimless olla LHB?.

Art.46 up, 98cm. "contained hand bones" Guinea Incised tripod support vessel, much of the neck and all the rim missing.

Chronologic assessment: end of Zoned Bichrome Period-Early Polychrome Period.

Burial 29: Individual found at 174 cm., in very poor condition. Oriented 31 degrees. Possibly placed in extended position, although the individual is in such poor condition it is difficult to tell; the interment of Burial 2 may have disturbed Burial 29, disarticulating the legs, but replacing them in what was perceived to be anatomical position, thus giving archaeologists a skewed position. Associated with a number of ceramic vessels placed along the west side of the individual.

Skeletal analysis: Based on bone size this individual is an infant 9 months -1 year, sex undetermined.

Associated artifacts:

Art 9, 63cm. Part of large vessel placed in burial fill

Art 51 up, 133 cm. Tola tripod bowl found under Art 81

Art 57 up, 149 cm. olla LHB? next to Art. 58

Art 58 up, 164 cm. olla LHB? next to Art 57

Art 59 down, 166cm. Tola tripod bowl, next to Art 58

Art 60 down, 153 cm. caps Art 63, Juanilla tripod bowl

Art 63 up, 156 cm. Charco Black on Red olla, found underneath Art.60.

Art 81 up, 167 cm. Tola w/o dots tripod bowl, found underneath Art. 51.

Art 9 down, 90 cm. large broken olla Type?

This burial group comprised of consecutive burials. May be a family unit.

Chronologic assessment: end of Zoned Bichrome Period

Burial 30: 8B. Individual encountered at 184 cm., on back in tightly flexed position, legs slightly to right side. Oriented 180 degrees, head to south, slightly compressed to chest. Right arm tightly flexed hand, drawn towards face. Left arm tightly flexed, hand raised towards face. Associated with two infant crania (Burials 18a,b), additional infant bones found 5 cm. above, and on the outside of the legs. Artifact 80 placed 10 cm. north of pelvis at 163cm., and Art 101 caps Art 80.

Skeletal analysis: Adult, sex undetermined.

Associated artifacts:

Art.80 up, 167 cm., olla, Los Hermanos Beige

Art.101 up? on top of Art 80, Miniature Espejo Black.

Chronologic assessment: Mata de Uva Phase, Zoned Bichrome Period.

Burial 31: 8A/B. Individual found at 188cm. in good condition. Placed on back in tightly flexed position. Oriented north, faces south, head compressed to left shoulder. Both arms flexed over chest, right over left, the hands directly over the ribs below the clavicles. Burial associated with number of grave offerings including two ceramic cones, Arts 85 and 86, placed to the north of the cranium, the opening resting on top of the cranium; one ceramic vessel placed next to these cones to the west (Art. 87), and another next to it (Art 84); 13 Strombus columella chisels or drills were placed on top of the chest, along with three chert hammerstones, and a Lyropecten subnudosis with a hole in the center; and a deer bone awl.

Skeletal analysis: Based on pelvic morphology individual is male. Dental attrition indicates an old-adult. Evidence of vertebral osteophytosis. Stature estimate based on femur and ulna: 162.88 +- 3.42 (Genoves 1967).

Associated artifacts:

Art.84 down 158 cm. Conical support bowl, Tola with dots

Art.85 177 cm. ceramic cone

Art.86 175 cm. ceramic cone

Art.87 up, 184cm., monochrome, gadrooned vessel, type unknown.

Arts.92a-m chisels or drills,

92n Lyropecten subnudosis with hole ("killed"):92o,p,q 3 chert hammerstones; 92r one deer bone awl.

Chronologic assessment: end of Zoned Bichrome Period-Early

Polychrome Period.

Burial 32: 8E. Primary burial found at 162 cm. in overall good condition, although only partially observed. Only legs observed, burial not entirely excavated, burial enters east sidewall. Heads towards southeast. Placed on back in extended position. Oriented 126 degrees. Arms unobserved. Artifact 36 placed to the left of left knee. To the left of this vessel, approximately 20 cm., are the dispersed remains of Burial 24 and MHC #2 (bone and shell sample).

Skeletal analysis: Based on bone size individual is an adult. Sex undetermined.

Associated artifacts:

Art. 36 side 99cm. globular tinaja under mojon, Brown ware. -MHC#2 Testudinata.

Chronologic assessment: possibly end of Early-Middle Polychrome Period.

Burial 33: 8D. Primary burial encountered in good condition at 190 cm, some phalanges present. Placed in flexed position maybe tightly flexed, legs to left. Left arm flexed, crosses midsection passing below the right femur, hand rests on top of right radius and ulna, possibly closed. Right arm flexed rests on top of right femur, right hand not present. Oriented 270 degrees, head towards west, rests on left temporal, the mandible open widely, looks north. Feet together right over left. One ceramic vessel Artifact 105 placed upside down above the cranium.

Skeletal analysis: Adult, possible male.

Associated artifacts:

Art. 105 down, conical support bowl, effigy, with head, tail and two wings appliques (bird), Carrillo Polychrome.

Chronologic assessment: Early Polychrome Period

Burial 34: 8D. Primary individual found in good condition at 205 cm.. Placed in semiflexed position on the right side. Oriented 170 degrees, head rests on right temporal, faces northeast. Left arm flexed. Right arm almost completely extended underneath the body. Individual associated with a number of grave offerings placed directly over the body two metates, one plain tripod and the other elaborately carved tripod (Artifacts 109 and 110) were placed upside down on top of the legs and upper torso; ceramic vessel Art 108 placed upside down to the east, next to and slightly underneath the metates; three other ceramic vessels Artifacts 106, 107, 111 and 112

placed on top of the upper body slightly underneath metate 110 and the head. In addition to these grave offerings, two cache offerings were placed in burial fill below Feature 1; the first cache located at the northernmost point of Feature 1 at a depth of approximately 1 meter, consists of Artifacts 1, 2, and 4 all ceramic vessels; cache two consists of a plain tripod metate and ellipsoidal mano (Arts. 44,45), ceramic vessels, and a celt found in the burial fill. See description of Feature 1.

Skeletal analysis: Middle adult, female.

Associated artifacts: 1,2,3,4,39,40,41,42,43,44,45 in burial fill. Art. 43 Carrillo effigy Cathartes aura (vulture).

Art.106 conical support tripod beige with red lip bowl type Juanilla Red on Beige

Art.107 wide mouth olla. Red Ware

Art.108 restricted mouth olla Juanilla Red on Beige

Art.109 down, low relief incised tripod metate with double-headed bird effigy protrusions: Ara macao (scarlet macaw).

Art.110 down plain tripod metate

Art.111 shallow dish, Brown ware

Art.112 conical support, effigy with head two wings and tail identified as Crax rubra, Tola.

Chronologic assessment: Early Polychrome Period

Burial 35: 8E. Fragmentary remains of primary individual encountered in medium state of preservation at 168cm. Approximately 40% of skeleton present yet able to ascertain individual placed on back in extended position. Arm position unknown. Oriented 70 degrees east of north, head towards east, rests on occipital. Near dispersed bones #1.

Skeletal analysis: Infant, sex undetermined.

No associated artifacts.

Chronologic assessment: Possible Middle Polychrome Period.

Burial 36: 8E. Primary individual encountered in good condition at 182 cm. below datum. Placed in extended position on back. Arms extended along sides. Oriented 80 degrees, head towards east, rests on occipital but leans to the left. Legs separated, the left leg somewhat elevated, perhaps in conformation to the pit floor. Ceramic vessel (Art. 113) placed to the right side of the head, and a rock placed near the right knee. Group of dispersed bones #2, cranial fragments and pelvic bones of another individual toward the middle right part of skeleton at 10cm. less depth, another isolated long bone

off the right humerus/clavicle, and bones on top of right knee. Burial definitely intrusive.

Skeletal analysis: Adolescent, perhaps female.

Associated artifacts:

Art.113 up, 180cm. Papagayo type copon vessel with feathered serpent or anthropomorphism swimming figure -associated secondary remains include skull and pelvic fragments.

Chronologic assessment: Extended burial position and associated Papagayo vessel indicate Middle Polychrome Period however, ribs of this individual radiocarbon dated to 105 A.D. and is considered highly suspect. See discussion of cemetery dating for analysis of this problematic date.

Burial 37: Burial found in the southeast sidewall of 8F and not excavated; a number of artifacts are found in association including a tubular jade bead and coral beads. Burial 37 will not be included in any burial counts or analyses but the types of artifacts encountered will be discussed as a lot (Cache 2); they cannot however, be included in artifact tabulations since it is unknown what additional grave offerings are associated with this individual.

Art.167 1 tubular jade bead

Art.185 1 tubular coral bead

Arts.186,187,188,189: 4 round coral beads

Burial 38: 8F. Primary individual found medium condition at 96 cm.-108 cm. Oriented 68 degrees east, head raised. Placed in tightly flexed position on back. Right arm flexed and rests on top of chest (over heart?). Left arm flexed.

Skeletal analysis: Child +-12 years old based on M-2's in occlusion, Lower I1, and L2's erupted and most in occlusion, Upper I1 and I2 unerupted. Good dentition. Sex undetermined.

No associated grave offerings.

Chronologic assessment: Tightly flexed individuals usually found during Zoned Bichrome and Early Polychrome Periods.

Burial 39: 8F. Primary individual encountered in good condition at 80 cm. Placed on left side in tightly flexed position. Right arm flexed and passes below the right femur and rests on top of the left leg, right hand articulated. Left arm position rare, humerus vertical, perpendicular to body, points to sky. The chest is smashed and only the spinous processes of the vertebral

column are present. The skull is missing; an isolated skull (IB#4) was found 35 cm. northwest of Burial 39 but it appears to be that of an infant and not Burial 39. Two vessels placed in burial fill; one (Artifact 120) with eight adult teeth placed inside.

Skeletal analysis: Adult, possible female.

Associated artifacts:

Artifact 120, 67cm., Cabuyal vessel w/ eight adult teeth found inside.

215 Miniature may belong to deeper burial.

Non Human Bone #3 Testudinata

Chronologic assessment: Cabuyal Polychrome is Middle Polychrome Period!

Burial 40: Redundant number. Not included in burial counts.

Burial 41: Fragmented isolated skull reassigned Isolated Bone #4. Located 35 cm. northwest of Burial 39. Appears to be and will be counted as an infant.

Associated artifacts: none.

Chronologic assessment: uncertain.

Burial 42: Unexcavated adult left in north sidewall. Not included in any burial counts.

Burial 43: 8F. Fragmentary remains of individual encountered at 97 cm. in poor condition. Consists of both femurs, part of the shaft of the right humerus, part of an ulna shaft, and an articulated mandible and partial skull. Bones are fragile. Placed on back in extended position. Oriented 85 degrees east of north, head turned to left side, faces south. The presence of the ulnar shaft above the head probably results from post mortem disturbance. No rocks or artifacts associated with this burial. One nondiagnostic potsherd, and one unworked Ostrea shell were associated, and are "probably unintentional inclusions" (Verano field notes). Absence of so many bones is puzzling-differential preservation and disturbance are the only hypotheses at present, anatomical position of the femurs suggests this is a primary burial and not a reburial.

Skeletal analysis: Old adult estimated from heavy and uneven dental attrition. Possible male based on large mastoid process. No stature data.

No associated artifacts although Artifact 148 lies 50 cm. to the south of the burial.

Chronologic assessment: Middle Polychrome Period?

Burial 44: 8F. The remains of a primary individual in poor condition encountered at 80 cm. to 88 cm. Overlaid with rocks and ceramic vessels. Oriented 300 degrees west of north, head west. Placed on back in tightly flexed position. Right arm tightly flexed with hand raised to chin. Left arm possible flexed across midsection. Burial is associated with the group burial 3 which includes burials 55,56,57,58, and 59. Artifact 194 placed upside down at base of right leg. Artifact 195 placed directly underneath right leg. Artifact 191, a fish vertebra bead was placed at the neck.

Skeletal analysis: Young adult, male. RM lost premolar.

Associated artifacts:

Art.194 down 89 cm. Brown ware with pisote Narica narica effigy head.

Art.195 up 86 cm. Charco Black on Red

Art.191 shark (Carcharhinidae) vertebra bead placed at neck.

Chronologic assessment: Charco Black on Red appears at the end of the Zoned Bichrome period.

Burial 45: Primary, fragmentary remains encountered in poor condition at approximately 105 cm. Consists of right arm, part of left humerus, partial scapula, several ribs and vertebral arches of an infant. No cranial material was found however, a ceramic vessel (Art. 177) was placed upside down on the area where the head should have been. The right arm is in anatomical position, semiextended. The scatter of many bones is either the result of poor preservation and/or postdepositional disturbance. Overall burial position impossible to determine. A small rock (P1) and a gastropod (C1) were associated with the burial but showed no signs of having been worked or altered. Artifact 178 was found approximately 30 cm. to the north of this burial but it is not clear if this vessel is associated with this burial or another burial.

Skeletal analysis: In the absence of dental remains, age estimated on the basis of long bone length which suggests age of less than one year. Sex undetermined.

Associated artifacts:

Art.177 down 177 cm. mammiform support shallow dish with three vertical loop handles. Juanilla Red on Beige - gastropod (C1)
-rock (P1)

Chronologic assessment: Juanilla Red on Beige (Sweeney 1975:131) with mammiform supports such as these are found beginning in the Early Polychrome period.

Burial 46: 8F. Primary individual encountered at 114-122 cm. Placed on back in flexed position legs to left side. Oriented 20 degrees east of north, head toward northeast and compressed to chest. Right arm flexed across chest. Left arm more tightly flexed with hand drawn up to left shoulder. Some differential bone preservation; innominate and lumbar vertebrae are gone. Postdepositional disturbance also a possibility. May be associated with Art 145, a conical support bowl placed upside down approximately 30 cm. to the southwest of pelvis at 98 cm. Shell placed at the feet of this individual.

Skeletal analysis: Middle adult, female?, based on small mastoids, small muscle attachment areas. Carious lower RP3, pre-mortem loss of lower RM2. No stature data.

Associated artifacts:

Art.145 down 98cm. Beige Ware, conical support tripod bowl with effigy head, tail and two wing appliques, bird, type uncertain.

-unidentified shell placed at feet.

Chronologic assessment: Early Polychrome period.

Burial 47: Primary individual in good condition encountered at 83-99 cm. below datum. Oriented 175 degrees, head to south. Placed on back in tightly flexed position, legs slightly to the right. Right arm tightly flexed with hand brought up to face. Left arm fully extended. Both feet are pulled in to such a degree as to suggest they were either bound (tied) or bent up to allow the body to fit in a small hole. A pot Artifact 192 was placed upside down over the head. This vessel contained two shell Strombus flange tools. Another pot, Art 163, placed upside down 5 cm. to the east of left foot. Another pot, Art 176, placed upright 10 cm. to the northeast of skull.

Skeletal analysis: Adult, female, based on greater sciatic notch. No stature data.

Associated artifacts:

Art.176 up 87 cm. conical support tripod bowl Red Ware?

Art.163 down 88cm. small tripod olla

Art.192a and b 76 cm two Strombus flange tools.

Chronologic assessment: Early Polychrome.

Burial 48: 8F. Primary, very well preserved infant skeleton found inside an inverted urn (Artifact 118) at 66cm.

Skeletal analysis: Infant probably stillborn or died shortly after. No dental remains found. Sex

undetermined.

Associated artifacts:

Art.118 down 66cm. Large urn burial vessel. Beige ware.
Chronologic assessment: Early Polychrome Period.

Burial 49: 8F. Articulated infant found inside vessel (Artifact 165) placed upright, with another capping it. The capping vessel (Art.164) also placed upright. Art 165 is a fairly large olla without neck and/or rim. It is extremely burned on the inside and outside of vessel. Art 164, is a conical support ray effigy bowl; this vessel is burned on the bottom exterior.

Skeletal assessment: fetal, sex undetermined.

Associated artifacts:

Art.164 up 60 cm. conical support ray effigy, Carrillo Polychrome. Caps Art.165.
Art.165 up, capped by Art. 164. Vessel broken at the top of the body of vessel, no rim or neck. Vessel very burned on inside and outside. There is no mention in the burial description of infant bones evidencing having been burned.
Chronologic assessment: Carrillo Polychrome found during Early Polychrome Period.

Burial 50: 8F. Primary individual encountered at 107-121 cm. Oriented 95 degrees. Placed on back in tightly flexed position, legs to right side. Both arms tightly flexed and brought up to face. Two rocks and one bowl, Art. 261, in association. Vessel placed upright to the southeast of cranium. Cranium deepest at 121 cm. Sacrum 119cm. and heel 107 cm.

Skeletal analysis: 12-13 years based on dental morphology. No evidence of anaemia, etc. No stature data.

Associated artifacts:

Art.261 up 116 cm., type Cervantes.
Chronologic assessment: Late Zoned Bichrome Period.

Burial 51: 8F. Primary, but fragmentary remains located at 119-122 cm. Oriented 100 degrees. Very incomplete remains but body was laid on its back, legs flexed to the right side. One of two infant burials in proximity; Burial 52 is 60 cm. to the east. They were both apparently interred together and share a number of grave offerings; Artifacts 150, 151, 152, and 153, all ceramic vessels, placed between the two infants.

Skeletal analysis: Fragmentary but can be aged well. Lower R1 crown complete, root partial, unclosed; Lower R12 erupting; upper R12 erupting. Individual is an infant.
Associated artifacts:

150 Charco Black on Red, effigy possible owl Tytonidae
151 almost purple, pedestal vessel w/ cross incision
152 Charco bowl
153 olla, LHB or Monte Cristo

Chronologic assessment: Traditionally these ceramic types are found during the Mata de Uva Phase of the Zoned Bichrome Period (B.C.300-500 A.D.) however, an associated carbon sample was dated B.C.575 +-120. This is a very early date for these ceramics but not impossible (see section on Dating the Cemetery). If the date is accepted, these infants are two of the oldest burials found to date in the beach cemetery.

Burial 52: 8F. Fragmentary remains of primary individual encountered in poor condition at approximately 120 cm. Possibly oriented in east-west direction although exact position impossible to ascertain. Associated with Burial 51 and the southeast area of 8F where a concentration of infant burials were found (see Cemetery Spatial Organization).

Skeletal analysis: Extremely fragmentary remains; no dental material, only some skull vault fragments and a vertebral centrum.

Associated artifacts: same as Burial 51.

Chronologic assessment: 14C to B.C.575 +-120, Zoned Bichrome Period.

Burial 53: 8H. Primary individual encountered in very good condition at 157-177 cm. Placed on left side in semiflexed position. Vertebral column curves slightly. Oriented 68 degrees east. Mouth down. Right arm tightly flexed hand below cranium. Left arm semiflexed hand below pelvis. Artifacts 208,209,210 placed on top of the left shoulder. One pot, Art. 207 and three Strombus flanges (Artifacts 213a,b,c) placed over lower left arm. One piece of pumice placed on top of the ribs. One Lyropecten subnudosis placed on top of the ribs at right elbow and forearm.

Skeletal analysis: Male based on sub-pubic angle and ischio-pubic ramus. Age estimated as older adult based on heavy tooth loss, endocranial sutures closed, pubic symphysis obliterated, 45 years +. Good stature estimate: 161.07 +- 3.42 (Genoves 1967).

Associated artifacts:

Art.207 down, 159 cm. Leon Punctate tripod support dish.

Art.208 side, 165 cm. On top of Art 209 and 210.

Juanilla Red on Beige (Sweeney 1975).

Art.209 down, 166 cm. on top of Art 210 Potosi Applique, has applique feline, crawly creature on top.

Art.210 down, 167 cm. underneath Art 208 and 209, Potosi Applique.

Art.213a,b,c, 162 cm. three worked shell flanges Strombus.

-piece of pumice placed on chest 175 cm.

-shell worked (Lyropecten subnudosis) with hole ("killed") 169cm. placed on right upper back.

Chronologic assessment: Potosi Applique and Leon Punctate diagnostic of Early Polychrome Period.

Burial 54: This burial was partially excavated during the 1981 field season. It was found 35 meters east of the mangrove swamp at meter 17 of 8G and entered the southern wall. Face down, left arm raised toward the face, legs unobservable; the observed remains were removed leaving the mid torso and legs in situ. In 1989 Op. 8L was opened to the south of 8G at meter 34-36 and the rest of the burial was excavated. The individual was placed face down in extended position on its stomach. Two large, cigar-shaped pestles were placed to the north of the cranium, as were the worked Strombus flange and drill. A mojon, Artifact 267, rests on top of the left femur. The tibiae and fibula of both legs are slightly elevated, most likely conforming to the burial pit. The feet point down. While removing the burial, two rocks (Artifacts 268 and 269), were found beneath the right and left sides of pelvis. Artifact 268 has a slight indentation and black area and was found under the left side and Artifact 269 was found beneath the right side. At 160cm., another rock was found Artifact 270. No additional cultural material was found below this burial. This was considered a very important burial because it was associated with two manos, an inner columella tool (Strombus) and a conch (Strombus) flange. I wanted to see if manos were gender restricted and could be used to in cases where sex could not be determined or in cases where no osseous remains survived. What was determined in artifact analysis is the misnomer of mano; morphologic evidence suggests these cigar-shaped stone tools more closely resemble pestles; they do however, appear to be male oriented (see description of Stone Tools).

Skeletal analysis: Male determination based on sciatic notch, shape of pubic symphysis and cranial morphology. The age at death was 20-25 based on dental evidence, epiphyseal union, and the first sacral vertebra is unfused. Stature is estimated by the maximum length of femur 43.1cm. No additional bone measurements available due to concretions on the bone. Good stature estimate (Trotter and Gleser 1952,1958):

2.44 (43.1) + 58.67 +- 2.99

105.164 + 58.67 + 163.834 +- 2.99

106.834 cm. mean
Range 163.834 - 2.99 = 160.844 Low
163.834 + 2.99 = 166.824 High

Associated artifacts:

202 cigar-shaped pestle
203 cigar-shaped pestle
211 Strombus shell
231 Strombus columella drill
232 Strombus flange
267 mojon 153cm.
268 nutting stone, tufa, perhaps slightly burned, 163cm.
269 nutting stone, tufa, 163cm.
270 stone, pumice, 160cm.

Chronologic assessment: Middle Polychrome Period

Burial 55: 8F. This primary burial is one of a group of 5-7 individuals interred together at 109-128 cm. (Group 2) This group include burials 55,56,57,58,59, and possibly 60 and 64 and 44. Oriented 25 degrees east of north. Burial 55 was found in semi-seated position, the lower legs are tightly flexed, with both feet pulled into the hips and the knees spread apart. The hands were placed on the groin area. Burial 55 leans against Burial 56. The right arm of Burial 56 is lying under the right arm of Burial 55, with the hand resting on the chest of Burial 55. Four ceramic vessels associated this Burial; Art 178 was placed upside down over the left knee; Art 195 placed over the left mandible and left shoulder of Burial 55, and over the right hand of Burial 56; Art 194 placed upside down against the right parietal of Burial 55 and over the chest of Burial 56; Art 200 placed on top of the lower left humerus of Burial 55.

Skeletal analysis: Old adult based on heavy tooth loss; female based on greater sciatic notch. Four carious teeth (numerous caries), and a markedly thin cranium: Bregma:<5mm, Asterion:<5mm. Both upper canines are shoveled. No stature data.

Associated artifacts:

178 down 96cm. tripod olla, type Zelaya Trichrome.
194 down 89 cm. conical support bowl with applique animal effigy, possible pisote, with hands up to face, Brown Ware.
195 up olla, Charco Black on Red
200 up, tripod bowl, Red Ware.

Chronologic assessment: end of Zoned Bichrome Period.

Burial 56: 8F. Part of group 2, burials 55, 56, 57, 58, and 59. Located immediately to the south of Burial 55. Oriented 210 degrees, head to south, chin compressed to

left shoulder, looks north (appears to look at Burial 57). Placed on back legs flexed to the left side, slightly separated. The left arm tightly flexed with hand drawn up to the face. Right arm travels under the right elbow of Burial 55 and rests on her chest. The cranium of Burial 55 rests on top of the legs of Burial 56. Cranium: 121cm; heel: 109.

Skeletal analysis: Young to middle adult, dentine exposed on lower M1's and upper PM1's. Female based on sciatic notch, pre-auricular sulcus. Femoral head diameter: 44 mm.

Associated artifacts: as described in burial description 55, one ceramic vessel rests over chest of Burial 56; and Art 195 placed over the right hand of Burial 56 and over the left mandible and left arm of Burial 55.

194 down, Brown ware, pisote effigy applique.

195 up, wide mouth olla, Charco Black on Red

Chronologic assessment: end of Zoned Bichrome Period.

Burial 57: 8F. Part of group 2, burials 55, 56, 57, 58, and 59. Located to the west of Burial 55 and 56. Oriented 180 degrees, head towards south, resting on right temporal. Head compressed to right shoulder, looks northeast (towards burial 55 and 56?). Placed on back with legs flexed to right side. Feet together. Left arm flexed passes below the right leg and on top of the left leg rests on right knee. Right arm flexed and meets the left hand at the left knee. Burial 58, an isolated skull with disarticulated mandible, was found with its face placed against the occipital of Burial 57.

Skeletal analysis: Middle-old adult based on heavy tooth wear. Female based on pre-auricular sulcus, greater sciatic notch, femoral head diameter (40mm.). Upper RM2 worn to roots, upper LM2-3 lost antemortem; heavy, uneven wear on upper incisors. Stature: maximum length of right femur: 433 mm.

Associated artifacts:

Art. 224 Guinea bowl with crawly figure iconographic element. Vessel contains three chert hammerstones, similar to those of Burial 31, three Anadara shells; and three bone frags.

Art. 123 Carrillo vessel.

Chronologic assessment: end of Zoned Bichrome Period

Burial 58: 8F. Part of group burial 2. Secondary remains (skull with disarticulated mandible) found placed against and slightly below the occipital of Burial 57 at 134cm.

For full details see burial descriptions 55 and 57.

Skeletal analysis: Female based on gracile skull

morphology, small face, muscle attachment areas poorly developed, mastoids small, small face.

No associated artifacts.

Chronologic assessment: end of Zoned bichrome period.

Burial 59: Part of Group 2, 5-7 burials including 55, 56, 57, 58, and 59. Located to the north and between two burial subgroups 55/56 and 57/58. Oriented north, head slightly compressed to chest and looks southwest seemingly at Burial 57. Placed in tightly flexed position on back legs to left. Right arm flexed hand drawn up to face. Left arm flexed across abdomen passing below the legs. Body goes to left but head turned other way. Associated with two ceramic vessels placed against the occipital.

Skeletal analysis: Mid-adult based on moderately heavy tooth wear. Male? based on large tooth size and squared-off chin. Lower LM2 lost antemortem, lower RM 2 carious, heavier tooth wear on right side, lower LM3 metrics: M-D: 13.9, B-L: 11.9 mm.

Associated artifacts:

Art.216 down, 97, tripod bowl missing supports, type unknown, very burned.

Art.216a worked Strombus flange tool found inside Art.216 184 olla LHB?

Chronologic assessment: Zoned Bichrome Period.

Burial 60: 8F. Secondary remains (bundle) in medium condition encountered between 85 and 102 cm. in proximity to group burial but not necessarily interred at the same time as the others. Longitudinally oriented 20 degrees east. Representative bone sample includes cranium, left pelvis, right radius, both ulnas, mandible and left maxilla, left (?) fibula, a radius fragment and several ribs. There were several potsherds associated with this burial placed to the east near the southern end of the bones. One shell placed on other side of the bones at the same southern end. Completely disarticulated, many bones missing (femora, tibiae, humerus, right fibula, ribs, phalanges). The lower RP3 was found inserted into the socket of RI; this apparent reinsertion perhaps took place during the reburial process.

Skeletal analysis: Female? based on partial greater sciatic notch w/? pre-auricular sulcus. 18-25 years old at death based on closed epiphyses, M3's unerupted but may be agenesis, and light toothwear. No stature data.

Associated artifacts: in burial fill

Art.141 side, 80 cm. Los Hermanos Beige.

Art.162 type unknown

Art.238 up, 70 cm. Juanilla Red on Beige bowl.

-one unidentified shell
-pot sherds at 94 cm.

Chronologic assessment: end of Zoned Bichrome Period.

Burial 61: 8G. Primary individual encountered in medium condition at 131 cm. Oriented 280 degrees east of north, head towards east, rests on right temporal, looks north. Placed in extended position on stomach. Left arm extended along side and right arm semiflexed passing below pelvis.

Skeletal analysis: Determined this individual female based on pre-auricular sulcus, greater sciatic notch, and gracility of long bones. Young to middle adult based on eruption of all teeth and cusps worn off M3's. No stature data.

No associated grave offerings.

Chronologic assessment: Based on body position, Middle Polychrome Period.

Burial 62: 8G. Adult foot left in sidewall. Not included in any burial counts.

Burial 63: Redundant number (AKA Burial 54).

Burial 64: 8F. May be part of group interment 2 consisting of burials 55, 56, 57, 58, 59, 60 and 44. Head towards northeast, rests on occipital, head slightly compressed to chest. Arms flexed across midsection left over right?

Skeletal analysis: 5-6 years old at death based on beginning eruption of all M's. Sex undetermined.

No associated artifacts?

Chronologic assessment: Interred after or at the same time as Group Burial 2.

Burial 65: Location? CAN'T FIND BURIAL RECORD.

VERANO'S SKELETAL NOTES SAY: 7 YEARS OLD, LEFT IN WALL?

FOB. MY NOTES SAY: TFB? NO ASSOCIATED ARTIFACTS?

Burial 66: 8G. Primary individual encountered in very good condition at 156-170 cm. Feet and hands present. Oriented 278 degrees, face down. Placed in extended position on stomach. Both arms tightly flexed drawn up to face; the left hand rests below the left side of face and the right hand passes below the right scapula resting at the right side of skull. Feet turned inwards. In

proximity to concentration of rocks and Burial 70. Associated with this burial are two ceramic vessels Art. 217 placed upside down 20cm to the south west of cranium and Art 218 underneath Art 217. It is difficult to tell if these artifacts belong to this individual or if they belong to Burial 70 however, it appears the grave offerings and rocks are part of Burial and not Burial 61. Skeletal analysis: Male based on sub-pubic angle and no sub-pubic concavity. +-24 years at death based on eruption of all teeth and in occlusion, and slight development of wear facets on M3's. Femoral diameter: (L) 41 mm.; (R) 42 mm. Stature: R. femur: 428 mm. maximum length
R. tibia: 367 mm. " "
L. tibia: 366 mm. " "
Associated artifacts: none.
Chronologic assessment: Middle Polychrome Period based on burial position.

Burial 67: 8F. Primary burial encountered in good condition at 139-148 cm. Oriented 180 degrees, head to south resting on left parietal, looks northwest. Placed in tightly flexed position on left side. Both arms tightly flexed together and raised toward face, hands present. Two worked shells Artifact 228a and b were placed against the nose. Skeletal analysis: Young adult based on little wear on M1's and M2's. Female based on greater sciatic notch, gracility of mandible, skull, and long bones. Associated artifacts: Art.228a.b., 2 worked shell ornaments

Burial 68: 8G. Primary burial encountered in good condition at 157 cm. Oriented 165 degrees east of north. Head to south, resting on left parietal, faces northwest. Placed on stomach in extended position. Left arm extended along side of body. Right arm semiflexed with hand passing under pelvis. Non-human bone #7 placed at 155 cm. on top of the mandible. (notes of Verano also refer to these as NHB6. Two worked bone tubes (Art 220) placed against right frontal. Skeletal analysis: Male based on greater sciatic notch, no pre-auricular sulcus, no ventral arc on ischium pubic ramus. Age estimated at +-17-19 years based on incomplete closure of epiphyses: lesser trochanters of femora, proximal femur, proximal humerus, left and right scapulae (glenoid fossa), and proximal tibiae. Upper LM3, RM3: alveolar eruption but not in occlusion. Lower LM3 unerupted, RM3 just breaking through. Stature: Left

humerus: 350 mm.

Associated artifacts:

Art 220 two worked human femora.

-NHB 6 or 7 Testudinata

Chronologic assessment: Middle Polychrome Period.

Burial 69: 8G. Primary burial encountered in very good condition at 160-175 cm. Oriented 262 degrees. Head towards west, resting on right parietal, looks south. Placed on back in extended position. Right arm extended along side of body with hand resting against the right proximal femur. Left arm semiflexed with hand resting on top of left proximal femur. Two worked shell flanges (Strombus) were placed on top of the pelvis and lower ribs. A spire lopped Olivella was placed against the left clavicle and a rock was placed on top of the left chest. Skeletal analysis: Male based on subpubic angle, subpubic concavity, ventral arc, ischio-pubic ramus, greater sciatic notch, pre-auricular sulcus. Femoral head size: 45 mm. Age estimated at 17-19 years based on incomplete epiphyseal union: distal femur, proximal tibia, vertebral centra; incomplete dental eruption: M3's not in occlusion; and Phase I pubic symphysis.

Associated artifacts:

-2 worked shell flanges Strombus 161cm.

-spire lopped Olivella 163 cm.

-rock 159 cm.

Chronologic assessment: Middle Polychrome Period

Burial 70: 8G. Primary burial in medium condition at 168 cm. Oriented 200 degrees. Head rests on left parietal. Placed in flexed position on left side. Arm position uncertain. Associated with Burial 66, two ceramic vessels and rocks. Base of cranium: 168 cm.; sacrum: 173 cm. Skeletal analysis: +-5 years old. Sex undetermined.

Associated artifacts:

Art.217 down, 159 cm. tripod dish with center punctations, Leon Punctate, caps Art. 218.

Art.218 up, 162 cm. olla, Brown Ware.

Chronologic assessment: Early Polychrome Period

Burial 71: 8F. Primary individual encountered in fair condition at 89-100 cm. Oriented 92 degrees, head towards east. Partially disarticulated; part of mandible found in anatomical position but the rest of the cranium was missing. A cranium was found 10 cm. to the west of left leg and it is likely it belongs to this individual, who was disturbed sometime after burial. Placed in flexed

position on right side. Left arm extended under body and passes below left leg. Right arm extended and passes between legs. One pot placed 10 cm. west of pelvis in the northern sidewall; another pot Art 222 placed partially under the cranium and to the west. Smashed remains of Art 133 found approximately 20 cm. east of anatomical position of cranium. Art 132 and Art 146 placed together with Art 133. Also has rocks.

Skeletal analysis: Older adult based on mandible, almost edentulous. Male based on greater sciatic notch. No stature data.

Associated artifacts:

Art.223 down? 110 Juanilla Red on Beige

Art.124 42 cm. highly burnished brown slip ware with sacrifice hole.

Art.222 dish with tab handle, Los Hermanos Beige possibly Art.133 sherds 95 cm.

Art.132 174 cm. tuft stone tool

Art.146 sherds 59 cm.

THESE LAST THREE ARTIFACTS MAY BE INTRUSIVE TO BURIAL 71; MAY HAVE CAUSED THE DISARTICULATION OF BURIAL 71.

Chronologic assessment: Early Polychrome Period

Burial 72: 8F. Fragmentary remains of partially disarticulated individual encountered at 130 cm. Oriented 5 degrees east of north.

Skeletal analysis: classified as "fetus" in the field, no long bones were identified in the lab. The frontal bones look about the right size for a stillborn, full term fetus.

Associated artifacts: Art.196a, Galo fish effigy, Bothidae, contained Art.196b, a Chavez Red on White vessel.

Chronologic assessment: Early Polychrome Period.

Burial 73: 8F. Primary individual placed in tightly flexed position on back at depth?. Oriented 210 degrees, head rests on occipital, looks at sky. Left arm flexed across midsection below left leg. Right arm ? One smashed pot to east of cranium.

Skeletal analysis: Middle adult based on moderate to heavy tooth wear. Female based on greater sciatic notch. No stature data. Pathology: Both tibiae show marked swelling due to periostitis and are bowed anteriorly. Cross sectional view of the bones shows opposition of spongy woven bones on the anterior portion of the diaphysis. Right ulna shows some swelling at proximal as well. Cranium too poorly preserved to see whether it was involved as well. Possible treponema infection.

Associated artifacts:

Art.176 up, 87 cm. red slip, conical support tripod bowl,
Chaparrita Red.

Non human bone #4 Testudinata

Chronologic assessment: Zoned Bichrome Period

Burial 74: 8F Primary burial, good condition but
disturbed, encountered at 89 cm. Oriented 125 degrees
from north, head towards east. Tightly flexed on back
legs to left. Cranium and left arm, right scapula
missing, most likely due to the intrusive interment of
Burial 75. Right arm tightly flexed.

Skeletal analysis: Age estimated at between 17-20 years
old at death based on incomplete dental eruption; upper
M3's not quite in occlusion, lower right M3 yes,
incomplete epiphyseal fusion: both iliac crests show
incomplete obliteration of epiphyseal lines. Female based
on greater sciatic notch, pre-auricular sulcus, femoral
head size: 35 mm.

Associated artifacts:

Art.143 up? 72 cm. broken olla

Art.144 in bag broken olla

Chronologic assessment: Early Polychrome Period

Burial 75: 8F Primary burial in fair condition
encountered at 92-11cm. Part of Group 3, oriented 155
degrees. Head rests on right parietal, faces northeast.
Placed in flexed position on right side. Left arm tightly
flexed and raised toward face. Right arm semiflexed.
Isolated cranium found at the feet of this burial; a
mandible placed on top to distal legs. This isolated
skull is most likely the disarticulated skull of Burial 74
located approximately 50 cm. to the southeast of Burial
75. This would make Burial 75 intrusive to Burial 74,
although Burial 75 also exhibits disarticulated parts most
resulting from subsequent interment of Burial 76.

Skeletal analysis: Child, sex undetermined.

Associated artifacts: see Burial 76

142 up?, 71 Guinea Incised: Gutierrez

160 down, 85 cm. tripod olla

197 down 112 cm. Tola tripod bowl

198 down, 113 cm. shallow plate tripod

199 Red ware punctated in center, conical support tripod

262 olla with handles, Yayal Brown.

Chronologic assessment: Mata de Uva of Zoned Bichrome -
Early Polychrome Periods.

Burial 76: 8F. Primary burial encountered in good
condition at 100-116 cm. Part of group 3 consisting of

burials 74, 75, and 76. Placed in flexed position on back legs to right side. Feet together. Left arm semiflexed passes over the pelvis and rests under the left femur. Right arm extended below the left tibia and fibula. Oriented 90 degrees, head towards east, chin slightly compressed to chest, looks west. Apparently this was the last intrusive burial of the three and is most likely responsible for the disarticulations of Burial 74 and 75.

Skeletal analysis: Middle adult based on completed dental eruption, complete epiphyseal fusion, dental wear moderate, heavy tooth loss. Male based on greater sciatic notch, pre-auricular sulcus, superior orbital margin, femoral head size: 45mm.

Associated artifacts:
142 up?, 71 Guinea Incised (Gutierrez)
160 down, 85 cm. tripod olla
197 down 112 cm. Tola tripod bowl
198 down, 113 cm. shallow plate tripod
199 Red ware punctated in center, conical support tripod
262 olla with handles, Yayal Brown

Chronological assessment: late Zoned Bichrome Period.

Burial 77: 8F. Primary burial encountered in medium condition at 125-137 cm. Oriented 10 degrees east of north. Head slightly compressed to chest, looks east. Placed in tightly flexed position on back. Right arm flexed with hand resting on right chest. Left arm less flexed passing below the legs hand rests below right leg on top of pelvis. Three pots Artifacts 245, 246, and 247 placed inside one another within 10 cm. to the east of the cranium.

Skeletal analysis: old adult, edentulous. Female based on greater sciatic notch, pre-auricular sulcus. Femoral head 44 mm. No stature data. Most bones present but fragmentary.

Associated artifacts:
154 up, tripod, 117 cm.
245 side 118 cm. Tola tripod support bowl, contains 246 and 247.
246 down inside Art 247, LHB? bowl
247 up inside 245 small conical support tripod bowl
Juanilla Red on Beige

Chronologic assessment: end of Zoned Bichrome - Early Polychrome Period.

Burial 78: Unexcavated burial left in situ 260 cm. west of 8I northeast boundary, 85cm. below datum "I". Associated with ceramic vessels of 8I. Not included in any burial counts although ceramics may be used as associated lot

(Cache 3). This burial, located at the mangrove swamp is the westernmost burial yet found in the beach cemetery.

Associated artifacts:

251 Large beige olla with red slipped lip, Juanilla Red on Beige.

252 broken olla

253 Charco Black on Red olla

254 Charco Black on Red olla

255 conical support bowl with effigy head, tail and two wing appliques, Red Ware.

256 Los Hermanos Beige

257 Charco Black on Red olla

Chronologic assessment: end of Zoned Bichrome

Burial 79: 8L. Burial encountered to the south of Burial 54 at a depth of 144-154 cm. It was placed in an extended position on its stomach. The left arm extended downward: the left hand is missing, as is the right arm although the right scapula is partially present. The cranium is also missing. An awkward alignment is found in the cervical vertebra and the first three cervical vertebrae are missing, a notable condition often found in cases of decapitation. At the seventh cervical vertebra the column takes a turn. This occurs again at the thirteenth or sixth thoracic vertebra. It is possible that the cranium was decapitated, and might possibly have been a cause of death, although this is speculative. At the very least, the cranium was severed while still covered with flesh possible within a few days after death or at death.

Photographic evidence supports decapitation before the onset of rigor mortis and would explain the odd vertebral position. There was no evidence of intrusive activities which might have removed the cranium. There were no observable pits and no evidence to support disturbance by the interment of Burial 54 found nearby, roughly at the same level. This missing cranium, right arm, and left hand will most likely provide interesting discussion of sacrifice, post mortum decapitation, and mutilation.

Skeletal analysis: Sex undetermined. Age at death 10-15 years most likely 13 years based on unfused vertebral epiphysis as well as femur and tibia, length of diaphysis. Stature estimation based on formula of Trotter and Gleser (1952, 1958) for Mexican. Femur size 340mm:

$$2.44 (34) + 65.53 \pm 3.94$$

$$82.96 + 65.53 \pm 3.94$$

148.49 cm. mean

$$\text{Range } 148.49 + 3.94 = 152.43 \text{ cm. High}$$

$$148.49 - 3.94 = 144.55 \text{ cm. Low}$$

No associated artifacts.

Chronologic assessment: probably Middle Polychrome Period.

Burial 80: Disarticulated bones found near west wall of 8J. May be part of Feature 18 although the feature range does not appear to include this burial. May have been disturbed by intrusive burial, possibly Burial 95.

Skeletal analysis: Possible adolescent or adult. Sex undetermined. Present skeletal remains include a small part of ilium, few ribs, fragment of scapula, parts of both humeri, part of diaphysis of ulna. Possible pathology of radius at the proximal third of radius, appears to be consolidated fracture showing heavy callus possibly generated by the fracture.

Associated artifacts: none.

Chronologic assessment: Interred before Burial 95; end of Zoned Bichrome Period.

Burial 81: 8J. Individual placed on back in extended position. Head to north, face turned toward the east. Arms extended along sides. Burial in very deteriorated state. Bones tend to fall apart during cleaning and removal. This may be due to the number of tree roots which have penetrated the bones throughout the burial especially in areas of the knee, right side of pelvis, right scapula, and cranium. No feet or hands observable most likely due to deterioration. Within 28cm. of the left arm are found isolated bones which appear to be cranial fragments. The maxilla is missing, probably due missing teeth, the subsequent softening of bones, caving in of the maxilla due to advanced age of the individual, as well as the weight of the earth upon the burial. Interred in proximity to Burial 82.

Skeletal analysis: Determines this individual Male? based on the size of the auricular articulation, general shape of sciatic notch which is only partially represented, and the nuchal line. Age is 40-50 years based on partial absorption of the parietals; lower 2nd. molar indicates age according to Lovejoy.

Associated artifacts: parts of two ceramic vessels placed at the right leg at 84 cm.

282a. Los Hermanos Beige

282b. Brown monochrome type?

Chronologic assessment: Middle Polychrome Period

Burial 82: Found in proximity to Burial 81. Individual placed on stomach in extended position. Arms extended along sides. Oriented 162 degrees, faces west. Bones in deteriorated state similar to Burial 81, most likely due to tree roots. No feet or hands present most likely due

to deterioration. Cranium completely penetrated by roots as is rest of skeleton. A cigar-shaped pestle placed next to left radius and ulna.

Skeletal analysis: Male based on sciatic notch, mandibular symphysis and ascending ramus angle. Age 18-20 yrs. based on dental attrition; third right mandibular molar has erupted. Individual exhibits many pathologies; femurs are bowed and swollen; both femurs affected. Radii appear healthy. Inflammation is localized in the diaphysis and doesn't appear to have affected the epiphysis, although distal epiphysis are not present. Severe osteomyelitis, possible treponema infection: possible syphilis. Exhibits similar pathology as Burial 72.

Associated artifacts:

Art.284 pestle, andesite, 100cm.

Art.299 stone, tufa, found below right thoracic cavity at 108cm.

Chronologic assessment: Middle Polychrome Period

Burial 83: Primary individual found at 94cm. extended on back with lower legs flexed, right leg flexed foot underneath left side of pelvis, left tightly flexed with foot resting between pelvis and left arm. Right arm flexed drawn toward right side of head, hand missing probably due to disturbance of subsequent burial; left arm extended along side. Head rests on right occipital, faces up and looks southeast. Face missing due to root penetration. Three unmodified rocks lay below the right arm and may have served as burial boundary.

Skeletal analysis: Female based on large sciatic notch. Age 40-45 years based on tooth attrition. Possible ochre-stained pelvis but discoloration could be due to tree roots.

No associated grave offerings.

Chronologic assessment: Early Polychrome Period, sometime after the interment of Burials 103, 104 and 109.

Burial 84: 8J. Primary individual encountered at a depth of 101-115 cm.. Extended on stomach. Oriented 280 degrees, head towards west on left side and faces north. Heavy root intrusion; roots enter cranium as well as disturbing right side of skeleton. Right arm appears extended although radius and ulna not present due to deterioration and root disturbance. Left arm extended with fingers resting between the legs below the pelvis. Left humerus, radius, and ulna missing most likely due to intrusion of Burial 98. An adult ulna is found in association with the infant Burial 98 and it is very possible this ulna originally belonged to Burial 84.

Skeletal analysis: Male? based on conflicting morphology; has masculine sciatic notch, masculine mandibular symphysis, teeth appear masculine; angle and size of ascending ramus appear female; individual appears tall but bones not adequate for stature estimation. Age determined around 25 years based only on dental attrition; left mandibular 3rd molar erupted. Has "peg" tooth at 3rd molar superior right side.

Associated artifacts:

Art.316 stone, chert, placed on top of right shoulder, 109cm.

Art.364 a,b,c, bone needle or pendant, possible hair pin, found during skeletal analysis in lab.

art.368 unworked stone, limestone

Chronologic assessment: Middle Polychrome Period

Burial 85: 8L. 126-140cm. Primary individual in flexed position on right side. Oriented 180 degrees, faces east. Left arm flexed and drawn up above cranium, cranium rests on top of radius and ulna, fingers project out from under the cranium. Legs flexed to right with left femur on top right but the right tibia and fibula cross the left at the ankle, the right foot on top of the left. Overall burial in very good condition. Ceramic vessel Artifact 287, olla type Charco Black on Red placed on the right femur at pelvis and calcaneus bones. Shell (Lyropecten subnudosis) Artifact 288 rests on top of right leg and outer rim vessel. One fossilized shell with central indentation (Artifact 305) and two unworked rocks placed to the west at feet of skeleton. One pumice stone was found in the burial fill. Appears to have ochre-stained right leg. This individual was covered by Feature 14, a concentration of shell and sherds. Feature continues into west and south sidewalls with few sherds to north.

Skeletal analysis: Male based on shape of pubic symphysis, skull morphology, sciatic notch somewhat controversial.

Age 20 years based on dental attrition and absence of vertebral arthritis.

Associated artifacts:

287 olla, Charco Black on Red and Cabuyal mix vessel

288 shell

303 pumice stone

304 Lyropecten subnudosis w/o hole

305 fossilized shell, possible snuff palate

Chronologic assessment: Early-Middle Polychrome Periods

Burial 86: Primary individual found in east wall of 8J approximately 1 meter south of north wall. Infant, in flexed position on right side. Oriented 90 degrees, faces

northwest. Cranium crushed. Right leg may be extended.
Olla, Artifact 290 placed

Skeletal analysis: Newborn-0.5 months based on femur
length 7.3 cm., humerus 6.5 cm. Age estimates according
to Ubelaker 1984:

Associated artifacts:

290 Los Hermanos Beige olla

Chronologic assessment: Zoned Bichrome-Early Polychrome
Period.

Burial 87: 8J. Infant. Cranium crushed. Possible
extended position. Oriented 190 degrees, faces south-
west. Ceramic vessel Artifact 291 found nearby. Burial
covered with rocks beginning at 40cm. to a depth of 75 cm.
This interment appears to have disturbed Burial 92.

Skeletal analysis: Femur: 7-8 cm.; Humerus: 6 cm.:
Newborn-0.5 months.

Associated artifacts:

291 tripod bowl, Tola, 112 cm.

370 worked shell

Chronologic assessment: end of Zoned Bichrome Period

Burial 88: 8J. Primary individual placed in semiflexed
position on right side. Oriented 200 degrees, cranium
missing; cranium may have been decapitated or disturbed by
subsequent interment. Right arm flexed 90 degrees across
body.

Skeletal analysis: Humerus: 6 cm. Newborn-0.5 months.

associated artifacts:

277 Leon Punctate

Chronologic assessment: Early Polychrome Period

Burial 89 does not exist.

Burial 90: 8J. Primary individual, cranium depth 78 cm.
Leg 100 cm. Tightly flexed on back legs to left side.
Head to north faces east. Right arm flexed and crosses
chest. Left arm flexed and drawn to chin. No feet or hand
bones. Burial very disturbed by tree roots. Cranium
crushed. Does not appear to have left leg or pelvis; may
have been disturbed by later burial. Oriented due north

Skeletal analysis: Male? based on cranial morphology. Age
35+-5 years (30-40 yrs.) based on dental attrition.

Associated artifacts:

302 worked-Strombus flange

Chronologic assessment: Zoned Bichrome-Early Polychrome
Period

Burial 91: 8J. Primary individual placed in tightly flexed position on right side. Cranium disturbed as is vertebral column and left half of ribs. Oriented 352 degrees, head towards north. Impossible to say which way faces because of disturbance. Left arm flexed with fingers curled across chest. Right arm flexed and drawn up to where chin should be. Left leg tightly flexed with foot resting at pelvis. Right leg tightly flexed underneath left and drawn up somewhat closer to chest and lies parallel to right arm. Overall condition good but parts disturbed perhaps by later interment of Burial 80 and 95 although Burial 80 may have been disturbed by this burial. 107 cm.- 114 cm.

Skeletal analysis: Sex undetermined possible female based on fragment of sciatic notch. Based on dental attrition this is a young adult definitely not older than 30 years or younger than 18 years - 20 years +- 2 years.

Associated artifacts:

Art. 273

Chronologic assessment: Interred after Burial 105 and construction of Feature 19.

Burial 92: 8J. Dispersed bones most likely disturbed by later burials. Associated with infant Burial 87 and may have been disturbed by this interment. They share association with ceramic vessel Artifact 291 but I think this vessel actually accompanies the infant.

Skeletal analysis: Representative skeletal remains: fragment of left mandible with part of ascending ramus, few incisors plus M1 and M2, PM1, PM2, M3; fragment of left maxilla with three: attached canine, PM1, and PM2; few cranial fragments including part of left temporal and left zygomatic; part of scapula; left patella; distal half of humerus diaphysis; fragments of diaphysis of ulna. Possible female. Age 25-35 years based on attrition of dental remains.

No Associated artifacts.

Chronologic assessment: uncertain

Burial 93: 8J. Primary individual whose position is difficult to ascertain, but appears to be oriented with the head towards north west. Found at depth of 122 cm. Infant associated with two ceramic vessels. Shell placed in mouth of vessel 295 mouth up 100 cm.

Skeletal analysis: Tibia: 6-7 cm.: Newborn-0.5 months.

Associated artifacts:

295 olla Los Hermanos Beige

296 quadrangular tetrapod ceramic vessel.

Chronologic assessment: Early Polychrome Period

Burial 94: 8J. Primary individual found at 102-117 cm. Placed on back in tightly flexed position, legs slightly to left side. Right arm flexed and crosses body with fingers resting on left humerus. Left arm tightly flexed with radius and ulna parallel to left leg and hand resting above left patella. Oriented 20 degrees from north, mouth up, slightly to side and faces southeast. Feet not visible but may have been disturbed during 1980-81 field seasons.

Skeletal analysis: Female based on ascending ramus and eye orbits; sciatic notch not as clear as previously mentioned criteria but individual definitely female. There is no apparent degeneration of the vertebra and the epiphysis are fused. Age 20-25 years.

Associated artifacts:

Art.294 olla with handles mouth up Los Hermanos Beige

Art.311

Art.312 bowl, mouth up, caps 313, Red Ware

Art.313 bowl, under 312, mouth up, Charco Black on Red

Art.314 blackware sherds type uncertain, possible Espejo Black

Art.315 worked bone

Chronologic assessment: end of Zoned Bichrome Period

Burial 95: 8J. Primary individual placed in flexed position on it's right side. Oriented 180 degrees, cranium on side faces east. Left arm tightly flexed to chin. Right arm tightly flexed to just outside chin. Left leg crosses right at ankle and feet are together. Found at depth of 116 cm.

Skeletal analysis: No fusion of epiphyses available for analysis. Approximately 12-15 years old based on dental remains. Sex undetermined in this sub-adult; morphology contradictory, gonial angle and size of ascending ramus appear masculine.

Associated artifacts:

Art.308 Charco olla, mouth down on top of left shoulder.

Chronologic assessment: end of Zoned Bichrome Period

Burial 96: 8J. Primary individual placed on back in flexed position (check this position). Oriented 36 degrees east of north, mouth up, faces southwest. Right arm flexed across abdomen hand rest on top of left radius and ulna at elbow. Left arm flexed across abdomen under right are. Lower extremity of body disturbed. Appears to

have left leg tightly flexed and drawn up to right side. Right leg appears to have been disturbed and later replaced; it is not in anatomical position and was most likely disturbed by later burial. Bones were found to the side of ceramic vessel Artifact 310 that was placed to the right of right elbow; these bones were examined in lab and identified by Maritza Gutierrez as Crax rubra or currasow, and has additional bones from unidentified bird.

Skeletal analysis: Male based on cranial morphology but sciatic notch appears female; this attribute apparently somewhat controversial within the biological population. Age older than 35 but not older than 50 years old. Vertebra unavailable for evidence of osteoarthritis and refined age determination.

Associated artifacts:

310 Red Ware vessel

MCH#8 Crax rubra, and other unidentified bird bone.

Chronologic assessment: Early Polychrome Period

Burial 97: 8J. Primary individual found at 140 cm. Cranium crushed. Oriented towards west but exact position impossible to determine.

Skeletal analysis: Age based on size of tibia: 6-7 cm.:

Newborn-0.5 months

Associated artifacts:

309 Tola, mouth up.

Chronologic assessment: end of Zoned Bichrome - Early Polychrome Period.

Burial 98: 8J. Individual found at 128 cm. Only fragmentary remains of infant. Orientation and position impossible to determine. Associated with complete left ulna of adult size. Most likely this ulna belongs to Burial 84 and was displaced during the interment of Burial 98.

Skeletal analysis: Newborn-0.5 months

No Associated Artifacts.

Chronologic assessment: Possibly interred after Burial 84 which is Middle Polychrome Period.

Burial 99: 8J. Individual found at 130 cm. Oriented south, cranium missing. An isolated infant cranium was found in 8F and it would not be unusual to find infants without head or other body parts missing, but I cannot discount the possibility of an overzealous excavator. Appears to have been placed on right side, legs possible flexed. One arm extended.

Skeletal analysis: Based on tibia size 9-10 cm.: infant

close to 6 months.
No associated grave offerings.
Chronologic assessment: uncertain.

Burial 100: 8J. Primary individual found at 155 cm. Oriented 90 degrees. Placed on right side. Left arm flexed with hand resting on right humerus. Right arm extended. Cranium on right parietal. Faces south. Legs possibly extended.
Skeletal analysis: Based on humerus size 6 cm.: Newborn-0.5 months.
No associated grave offerings.
Chronologic assessment: uncertain.

Burial 101: 8J. Primary individual found at 145 cm. Placed on right side in flexed position. Oriented 328 degrees, heads towards northwest. Appears to face west. Left arm extended. Right arm flexed underneath body and rests on top of legs. Both legs flexed and drawn up to chest. Close to Feature 18 and might be responsible for the disturbance of "Huesos M".
Skeletal analysis: Based on fibula size 6-6.5-7 cm. and femur 8 cm.: infant is Newborn-0.5 months.
No associated grave offerings.
Chronologic assessment: uncertain.

Burial 102: 8J. Primary individual found at 143 cm.- 171 cm. (seated). Placed in flexed position on back with legs to left side. Oriented 4 degrees, faces southeast. Arms flexed 90 degrees with the right over the left. Left foot flexed and points to sky. Artifact 317 tripod bowl placed mouth down at the feet of the burial; Artifact 318 olla placed mouth down on chest against right side of cranium; Artifact 319 olla with handles placed on side above cranium; Artifact 320 placed mouth up on top of Artifact 321 to right of cranium above scapula; Artifact 321 placed mouth up underneath Artifact 321. Two stones, Artifacts 322 and 324, found on left side of chest next to left humerus. Two shells Artifact 323 found together with Artifact 322 underneath Artifacts 319, 320, 321; Artifact 325 found underneath Artifacts 320 and 321. Possible ochre-stained pelvis but also possible due to root contamination. Water table close; burial very damp.
Skeletal analysis: Female based on sciatic notch and gracile cranial morphology. Age estimated at 20-25 years closer to 25 years based on dental attrition and condition of vertebral bodies; no evidence of arthritis. Dental problems, missing teeth, lots of osteoporosis of jaw yet

few caries.

Associated artifacts:

317 tripod bowl, mouth down, Tola

318 olla mouth down, Tola

319 sm. olla w/ handles, mouth up on side, Brownware
unknown

320 caps 321, mouth down, Tola

321 underneath 320, mouth down, Los Hermanos Beige

322 stone

323 shell

324 worked stone

325 shell

373 found inside 321, Tola

Chronologic assessment: end of Zoned Bichrome Period to
Early Polychrome Period.

Burial 103: 8J. Primary individual placed on back in tightly flexed position; legs drawn up and folded on top of chest/abdomen. Oriented 340 degrees, faces up, southeast. Right arm extended along right side. Left arm flexed and crosses abdomen underneath legs. Feet may have been tied together. At the left elbow is Artifact 341, a mammiform support vessel, mouth down; on top of this vessel were the fragmentary remains of Burial 109. It is possible that this burial was interred at the same time as Burial 104 and 109. They are close together, at the same level, and do not appear to have intruded upon the other. The secondary remains of Burial 109 were reburied with Burial 103 and 104. Within 15 cm. to the east of Burial 103 and 5 cm. south of Burial 109 is Burial 104, an adult male?. Burial 104 is accompanied by an array of grave offerings (see next burial description). Group burials are not unusual in this cemetery and there does not appear to have been any intrusion; individual pits are not discernable.

Skeletal analysis: Male based on sciatic notch, supraorbitals, large mastoid process, shape of mandible and ascending ramus. Age estimated at 18 years based on "billowed" surface of vertebra which indicate the epiphyses are not fused. Fusion occurs between 17-25 years. Femoral epiphysis unfused and the femur head is barely fused. Overall very good condition and representative. Lower M3 erupted has caries-same as upper left. Pathology: penetration or infection of tendon of right clavicle, near the external part, close to sternal articulation; it has healed indicating it happened years before death. Stature estimation based on maximum length of femur 42.8 cm. (Trotter and Gleser 1952, 1958):

$$2.44(42.8) + 58.67 \pm 2.99 =$$

$$104.432 + 58.67 = 163.106 \pm 2.99$$

Range $163.106 - 2.99 = 160.112$ cm. Low
 $163.106 + 2.99 = 160.112$ cm. High

Chronologic assessment: end of Zoned Bichrome Period

Burial 104: 8J. Primary individual found at 170 cm.-185 cm. On back tightly flexed. Head toward north. Left arm tightly flexed with hand drawn up to left side of mandible. Right arm flexed with radius and ulna drawn up to face. Right tibia directly over femur; left tibia falls to the inside of femur. Metatarsals touch. Bones very friable. Facial bones essentially nonexistent; this could be due to advanced age and tooth loss that causes face to cave in. A number of grave offerings placed around the body: One mano and metate placed at the feet, metate right side up and mano protrudes underneath right side until almost reaching pelvis. Ceramic vessel (Art. 348) rests against the southwest corner of metate mouth up. Vessel (Art. 349) olla on side mouth up placed above southeast part of Art. 348, its body partially fits into the mouth of Art. 340, a pedestal support placed on its side. Placed on top of Art. 348 were a number of shells, stone tools and rocks; one stone pestle was placed inside a Ficus ventricosa shell. Two other shells both Ficus ventricosa were laid on the inside of the right leg at the patella. Another ceramic vessel was placed mouth up to the left side of cranium on top of left hand; it's a small pedestal plate missing support similar to alligator ware (Leon Punctate). Within 10 cm. north and 10 cm. west lies Artifact 341 and infant Burial 109. An olla with handles rests against the right side of Art. 341, mouth up. Another ceramic vessel (Art. 351) underneath Art. 341 mouth up. The original burial pit appears to have been dug to approximately 190 cm. The grave offerings were laid at the feet against the southern wall. I believe this burial was interred at the same time as Burials 103 and 109.

Skeletal analysis: Male? based on fragment of auricular ridge, fragment of sciatic notch, and a marked masculine nuchal line; because of the fragmentary nature of these remains it is best to consider sex as male?. Age 45-50 years based on reabsorption and obliteration of cranial sutures. Pathology: exhibits signs of mechanical arthritis of patella. No lower teeth.

Associated artifacts: 338 plain tripod metate
339 ellipsoidal mano
340 vessel rim, negative resist, Red Ware
341 mammiform support, Leon Punctate.
348 olla mouth up Juanilla red?
349 olla on side, mouth up, Tola
350 alligator ware bowl, mouth up

351 underneath 341 mouth up Red ware

362 pestle

363 pestle

367 a Ficus ventricosa shell

b Ficus ventricosa shell

c Ficus ventricosa shell

d Ficus ventricosa shell

e Lyropecten subnudosis shell

f Anadara shell

g unworked stone, ignimbrite

h unworked stone, ignimbrite

i unworked stone, limestone

Chronologic assessment: Early Polychrome Period

Burial 105: 8J. Primary individual encountered 167 cm.-185cm. Oriented due north. Placed on back in flexed position, legs left, right on top of left with the left leg slightly to north and east. Left unobservable as is most of pelvis. Arms flexed and cross abdomen/chest left over right. No hand bones observable. Head to north. Cranium slightly elevated chin to chest, faces east. Facial bones practically non-existent. Overall poor condition; bones very soft. This burial is below water table level, hence soil very damp-upon exposure to air and sun bones become extremely friable making recovery difficult. An olla Artifact 327 placed on its side just south of the pelvis next to right foot. Artifact 328 plate or bowl in the west sidewall slightly above and to the west of Art. 327 A small bowl Artifact 273 was found at 93 cm. on its side above Art. 327. This burial has several large rocks surrounding it and appears to be part of a concentration of shell and small rocks (Feature 18). The feature is not (in the opinion of Geologist Cesar Laurito) natural but rather appears to be a type of floor between extremely damp soil and the burial. See description for Feature 18.

Skeletal analysis: Female? based only on cranial morphology; poor condition of skeleton allowed no recovery of pelvis or vertebra. Ascending ramus appears female. All molars lost-may have premolars (lower left premolar and canine present) age 40-50 years based on the obliteration of cranial sutures and tooth loss. Has an extra frontal suture which runs to the nose.

Associated artifacts:

327 on side, capped by 328, Red Ware

328 caps 327, Plate or bowl supports missing, Leon Punctate

Chronologic assessment: Early Polychrome

Burial 106: 8J. Primary individual found at 165-180 cm. More on left side than on back, legs flexed to left. Right leg crosses body at abdomen. Left femur passes underneath right leg near upper right tibia and continues a little to the east and is slightly elevated. Arm flexed with right hand resting on top at midpoint of left radius and ulna. Left arm passes underneath right hand and right femur with the left hand resting on top of left femur. Oriented due north, mouth to side, faces southeast. Tripod bowl Artifact 336 placed upside down, underneath left knee; an olla, Artifact 335 placed mouth up and rests against the southwest end of Artifact 355; resting against the southern support of Art.334 was found Art.333, a tripod support bowl placed mouth down; Art. 345 placed mouth down approximately 7 cm. east of Art.333, and rests on top and to the side of Art.346 which was placed mouth up. Artifacts 271, 272, 292, 298 in burial fill.

Skeletal analysis: Male based on pelvis, inner acetabulum and auricular articulation; shape of ascending ramus, brow ridge, and chin. 35-40 years old based on evidence of osteoarthritis in cervical vertebrae (lipping), and dental attrition.

Associated artifacts:

271 Los Hermanos Beige
272 all beige
292 Los Hermanos Beige
298 Red Ware
333 Leon Punctate, mouth down, tripod support bowl
334 tripod vessel on side, Guinea Incised
335a olla, mouth up, Los Hermanos Beige
335b stone, basalt, placed on top of 335a
336 bowl or plate mouth down, Los Hermanos Beige
345 caps 346 mouth up, Red Ware
346 underneath 345 mouth up, Type unknown
342 underneath 333, Red Ware

Chronologic assessment: Guinea Incised appears during the Mata de Uva Phase of the Zoned Bichrome Period but Leon Punctate is Early Polychrome. Burial best considered as Early Polychrome Period.

Burial 107: 8J. Several long bones present, position indeterminable. Tola vessel placed on side mouth up, Coral beads found while cleaning burial.

Skeletal analysis: Age estimated between 0.5-1.5 years; this burial and Burial 99 are older than the other infants encountered which are no newborns.

Associated artifacts:

Art.337 Tola Trichrome
Art.344 44 coral beads

Chronologic assessment: end of Mata de Uva Phase of Zoned

Bichrome Period or Early Polychrome Period.

Burial 108: 8K. Primary individual found at 122-136 cm. in the small pit cut between the ovens of 8K; burial covered by two layers of rocks. Placed in flexed position on right side. Oriented 350 degrees, head to north, faces west. Left arm flexed crosses body to thorax and rests on top of right arm. Right arm tightly flexed with hand drawn up to chin. Remains in very good condition with phalanges present. A canine burial is found at the same depth approximately 80 cm. to the east (MCH#7). While cleaning cranium in the lab a jade pendant was found pressed against the left side of mandible indicating pendant worn around the neck. Also found with this burial were sherds of a brown monochrome vessel, none diagnostic; one piece of siltstone and four pieces of tufa.

Skeletal analysis: Female based on cranial morphology and fragment of sciatic notch. Age 35-40 years based on dental attrition; vertebra unavailable for analysis of osteoarthritis. Teeth evidence enamel hypoplasia.

Associated artifacts:

361 Jade pendant
-sherds of monochrome brown ware nondiagnostic
-piece of siltstone
-4 pieces of tufa

Chronologic assessment: Jadeite/greenstone objects are found in Costa Rica from the latter part of Zoned Bichrome through mid Early Polychrome Period, 300 B.C.-A.D. 700, (Lange and Bishop 1988:73).

Burial 109: 8J. Partially disarticulated. This individual was found in association with Burials 103 and 104. It was placed on top of a ceramic vessel (Artifact 341). Only ribs were observed, however, an infant mandible was found approximately 10 cm. south and 15 cm. deeper near the right shoulder of Burial 104. Artifact 341 is a Leon Punctate type grater bowl with mammiform supports. Vessel was placed mouth down. To the immediate east of this vessel was Art.347, mouth up at 170cm. Below Art. 341 was placed mouth up Artifact 351 a tripod mammiform support vessel type Red Ware.

Skeletal analysis: Infant approximately 1 year. DM1&2 right inferior not erupted; D1&2, DC inferior not erupted; mandibular canines not erupted; whole crown of 1st molar erupted.

Associated artifacts:

341 Leon Punctate, mouth down
347 Yayal, olla with handles, mouth up
351 Red ware, mammiform support

Chronologic assessment: Early Polychrome Period.

Burial 110: 8K. Primary individual found at depth of 130-155 cm. below oven #2 (Feature 13) of 8K. Placed on back in tightly flexed position. Individual was covered with rocks. Oriented 90 degrees, head towards bay, faces slightly northwest. Left arm flexed and passes underneath the left femur-tibia-fibula the hand rests next to right leg hand toward face. Right arm extended down along right side of pelvis. Ceramic vessel Artifact 352 was placed at the right hand, mouth up but on side at 139 cm. A Lyropecten subnudosis with center hole (Artifact 366) and a celt fragment (Artifact 365) was found in the burial fill below the ovens and above the rocks at 50-80 cm.

Skeletal analysis: Male based on cranial and pelvis morphology. Many missing teeth: no incisors nor molars except 3R lower. Much osteoporosis of maxilla, lots of arthritis of thoracic vertebrae. 40-45 years, dental attrition difficult due to so many missing teeth.

Associated artifacts:

365 stone celt fragment

366 Lyropecten subnudosis with center hole ("killed")

352 ceramic, mouth up, on side, Congo Punctate

Chronologic assessment: end of Zoned Bichrome Period.

Burial 111: 8K. Primary individual found at 185-200 cm. in the small trench cut between the ovens of 8K. Burial covered by rocks. Individual placed on stomach in extended position. Oriented 198 degrees, head toward south, faces east. Left arm extended along left side of body, palm down. Right arm tightly flexed with hand underneath right shoulder, fingers unobservable. A stone celt was found underneath the right hand.

Skeletal analysis: Male based on shape of ascending ramus, mandibular foramen, and pelvic criteria. No lipping or evidence of arthritis on lower vertebra suggest age of 25-30 years; the teeth however are very worn and appear to belong to an individual of 40-45 years but this is most likely due to diet. RVL believes this individual @27 years.

Associated artifacts: 360, basalt celt

Chronologic assessment: Middle Polychrome Period.

Burial 112: 8J. Primary individual found at 157-174 cm. Placed on its back with legs flexed to right. Left arm flexed and drawn across chest rests underneath right leg, hand unobservable. Right arm rightly flexed and drawn up to chin. Oriented 80 degrees, head at odd angle mouth to

the side, faces west. Associated with number of grave offerings which are found in the burial fill. Art. 354 at 132 cm. olla mouth down caps 355 at 154 cm. also mouth down olla; both of these were placed above the left shoulder and rest against the cranium; a mano-like stone tool Art. 356 at 149 cm. rests next to these vessels; Art. 353 found mouth up at 149 cm. and rests on top of right shoulder. The remains entered the north wall and a window was cut into the sidewall to assist excavation. Above the burial in the window was found Art. 357 mouth down at approximately 125 cm. above Art. 354; below Art. 355 were found Art. 358 and Art. 359. Art. 358 found mouth down caps 359 found mouth up.

Skeletal analysis: Male based on cranial morphology, height of auricular arch. Few vertebra observable, no evidence of arthritis in long bones. 35-40 years based on dental attrition.

Associated artifacts:

353 olla without rim, mouth up, 149 cm. LHB?

354 olla mouth down, caps 355, 134cm. LHB

355 tripod support bowl supports missing, 154 cm., mouth down underneath Art. 354, Zelaya

356 mano 149 cm.

357 tripod mammiform vessel, mouth down, Leon Punctate.

358 mouth down caps 359 1/2 red slip Juanilla red on beige

359 mouth up underneath Art. 358 Red Ware

This individual also associated with Burial 113, an infant found inside vessel Art. 357.

Chronologic assessment: Early Polychrome Period.

Burial 113: 8J. Secondary individual found inside vessel 357 while vessel was cleaned in the lab. Associated with Burial 112. Artifact 357 is Leon Punctate placed mouth down at approximately 125 cm.

Skeletal analysis: Tibia size 66mm. Infant is Newborn-0.5 months.

Chronologic assessment: Early Polychrome Period.

SECONDARY REMAINS ASSOCIATED WITH FEATURE 18 OP.8J

- "A" proximal fragment of left ulna, distal fragment of radial diaphysis, two rib fragments: possible adult, sex undetermined.
- "B" fragment of radius diaphysis which has a consolidated tercio fracture of distal area, few fragments of ribs: possible adult or adolescent, sex undetermined.
- "C" three rib fragments, one small fragment of possible ulna, fragment of radius diaphysis: possible adult or adolescent, sex undetermined.
- "D" fragment of humerus diaphysis: possible adult.
- "E" consists of vertebrae, foot bones, pelvis fragment, scion of pelvis, ribs, hand bones, one right ulna and right radius: These remains represent one adult individual, based on bone size, it is a possible male, although this is very speculative.
- "F" right humerus, right femur diaphysis, ribs, vertebrae, left clavicle, left scapula, part of mandibular body of right side with six teeth, one ulna diaphysis, one radius diaphysis, one metacarpal: This is a very robust individual and is most likely a male.
- "G" cranial fragments, part of a scapula, scion fragment, 1/3 proximal humerus, fragment of proximal subtrochantus of femur: Based on size, this individual is an adult male, the condition of the bones is very similar to "F" and may be the same individual.
- "H" ilium fragment including part of sciatic notch, nine metatarsal fragments, two foot phalanges, fragment of the head of femur or humerus: Adult, sex undetermined.
- "I" part of right mandible with teeth including PM1, M1, M2 (M2 has odd shape and an extra cusp); left scapula, three ribs fragments, one radius diaphysis, few metatarsals, fibula fragment: At least two individuals

represented; the mandible belongs to an individual 15-25 years old; the other bone fragments are not from this same individual, sex undetermined.

"J" fragment of radius diaphysis, rib fragment, four unidentifiable fragments: Possible adult, sex undetermined.

"K" consists of least two individuals: fragment of proximal diaphysis of humerus, adolescent or female; another humerus diaphysis, larger than the previously mentioned humerus, of an older individual; vertebral fragments, rib fragments, fragments of radius diaphysis, fragment of ulna diaphysis, hand phalange.

"L" fragment of right proximal humerus, fragment of distal femur, fragment of axial ridge of scapula, fragment of left mandible with 1st and 2nd molars: Based on dental attrition individual is 15-25 years old, sex undetermined.

"M" ribs, pelvis fragments, vertebrae fragments, hand phalanges: Adolescent or adult, sex undetermined.

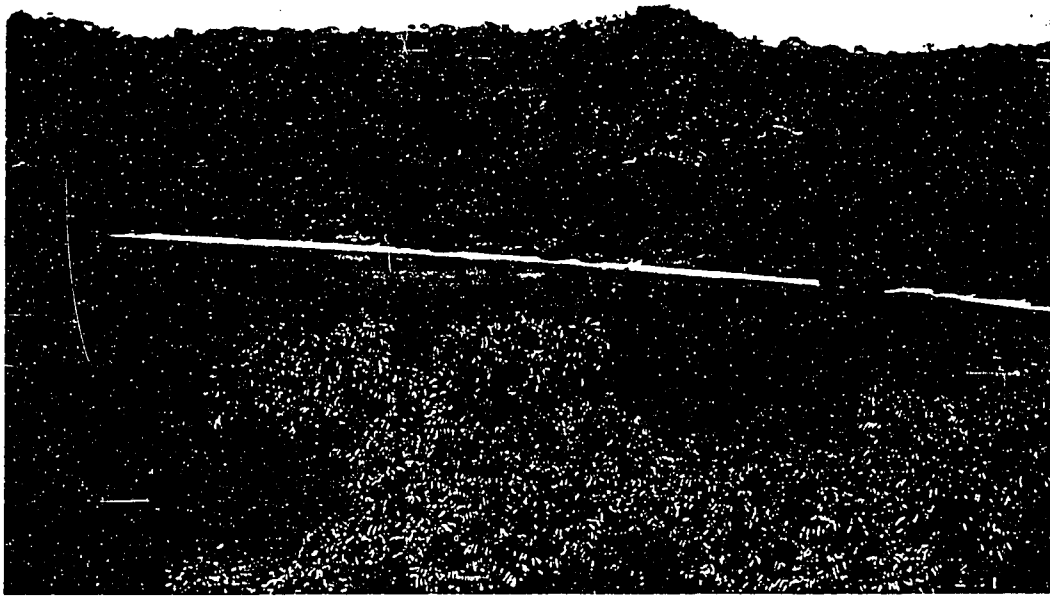

Pl.1 Top: Nacascolo site looking west from Cascabel.
Bottom: View of Nacascolo valley, mangrove swamp and bay.



Pl.2: Nacascolo beach cemetery Op.8A-E.

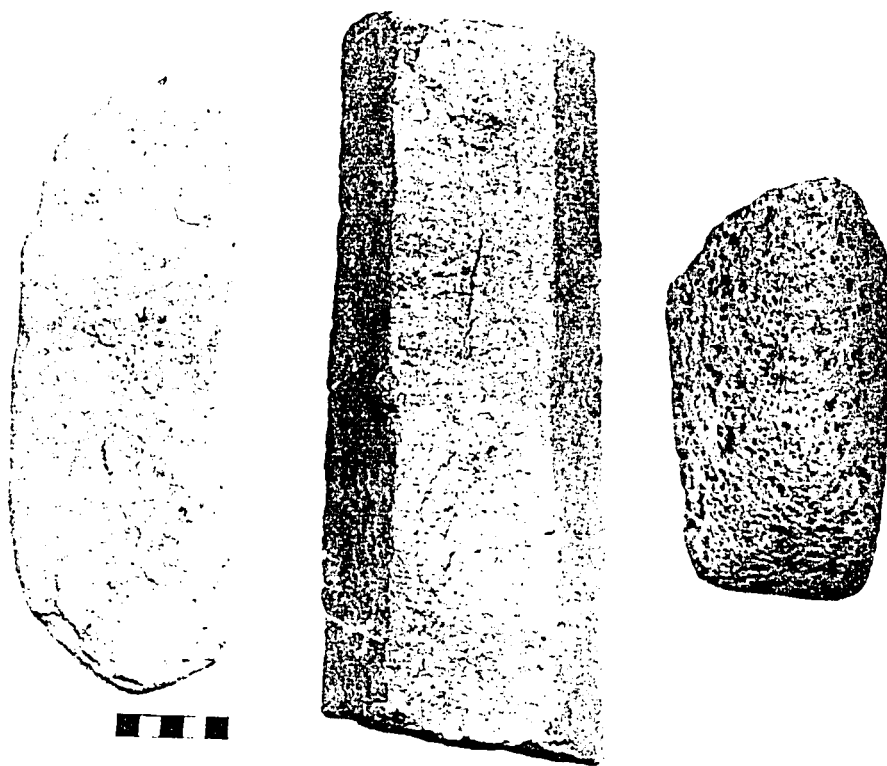

Pl.3: Profile of "hueco grande" one of the excavations of Juan Dada. Notice the columnar ignimbrite mojon in wall. Below, are types of stone referred to as "mojones," A and C should be considered unclassified stone tools.

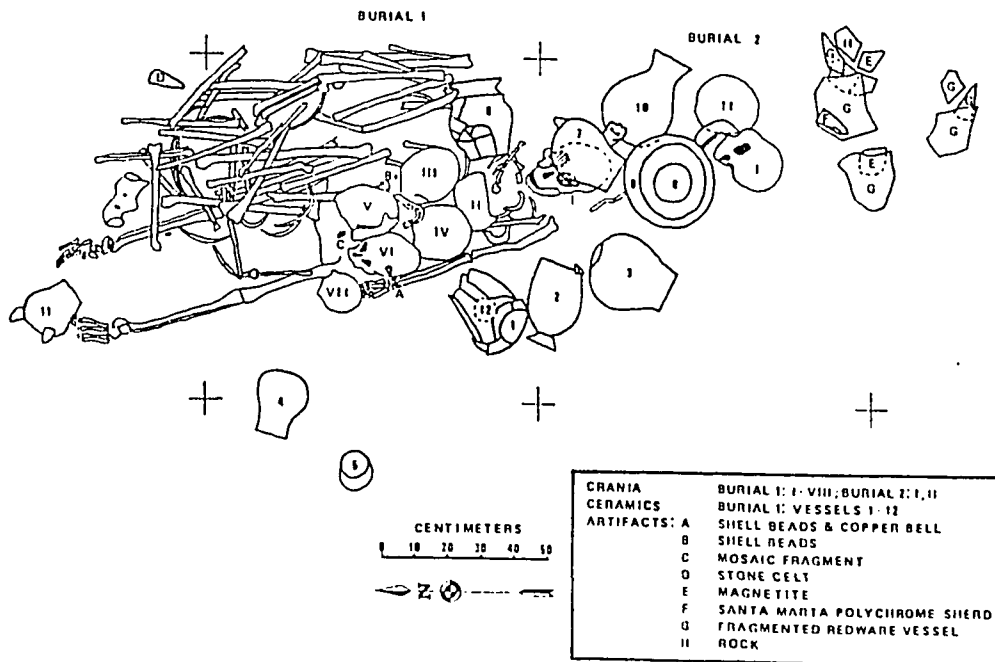
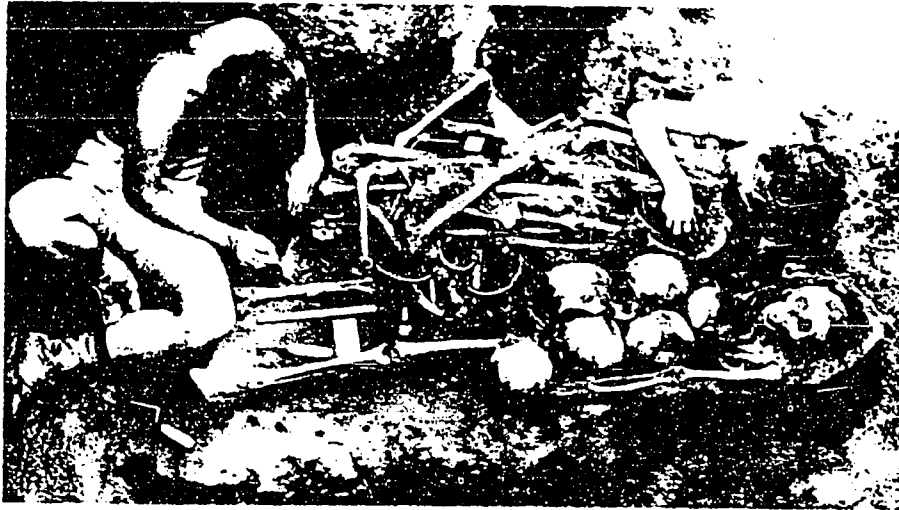

Pl.4: Combination Burial excavated by Wallace and Accola, Nacасcolo.



NACASCOLO
GUANACASTE
COSTA RICA
OPERACION SA
3 AGOSTO 1980
RICK UCL

Pl. 5 Nacascolo Op.3a cist tomb.

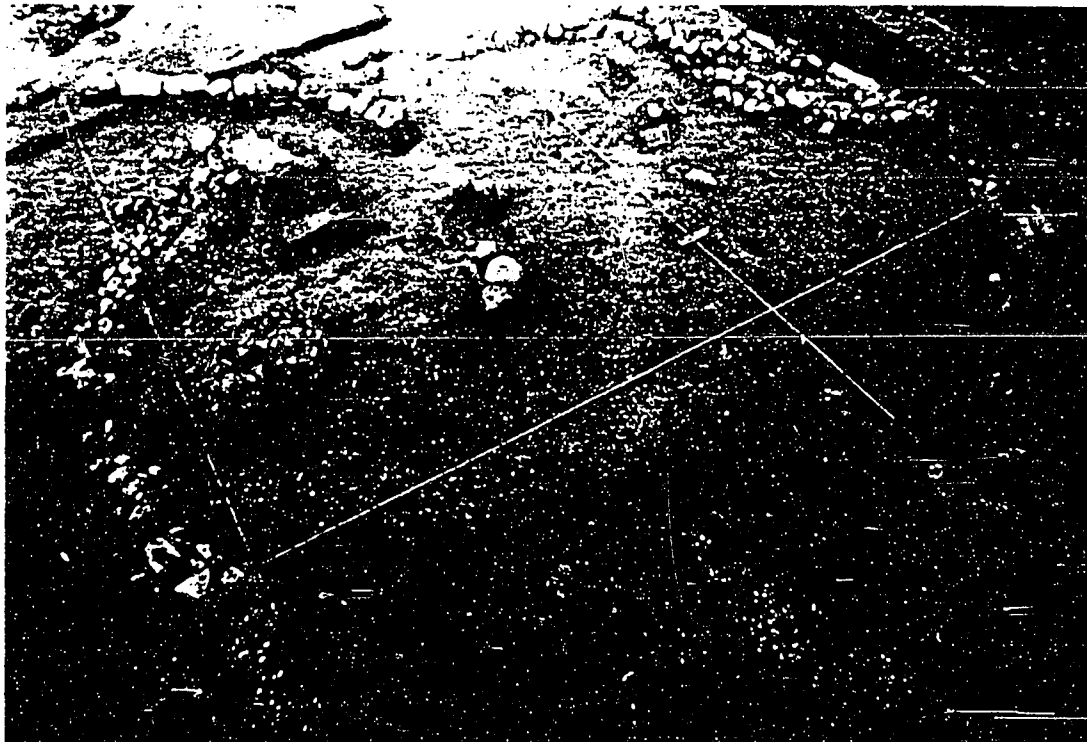

Pl. 6 Nacascolo house foundations.



Pl. 7: Huaquero pit in beach cemetery.



Pl. 8: Clearing brush from beach area in preparation for cemetery boundary test.

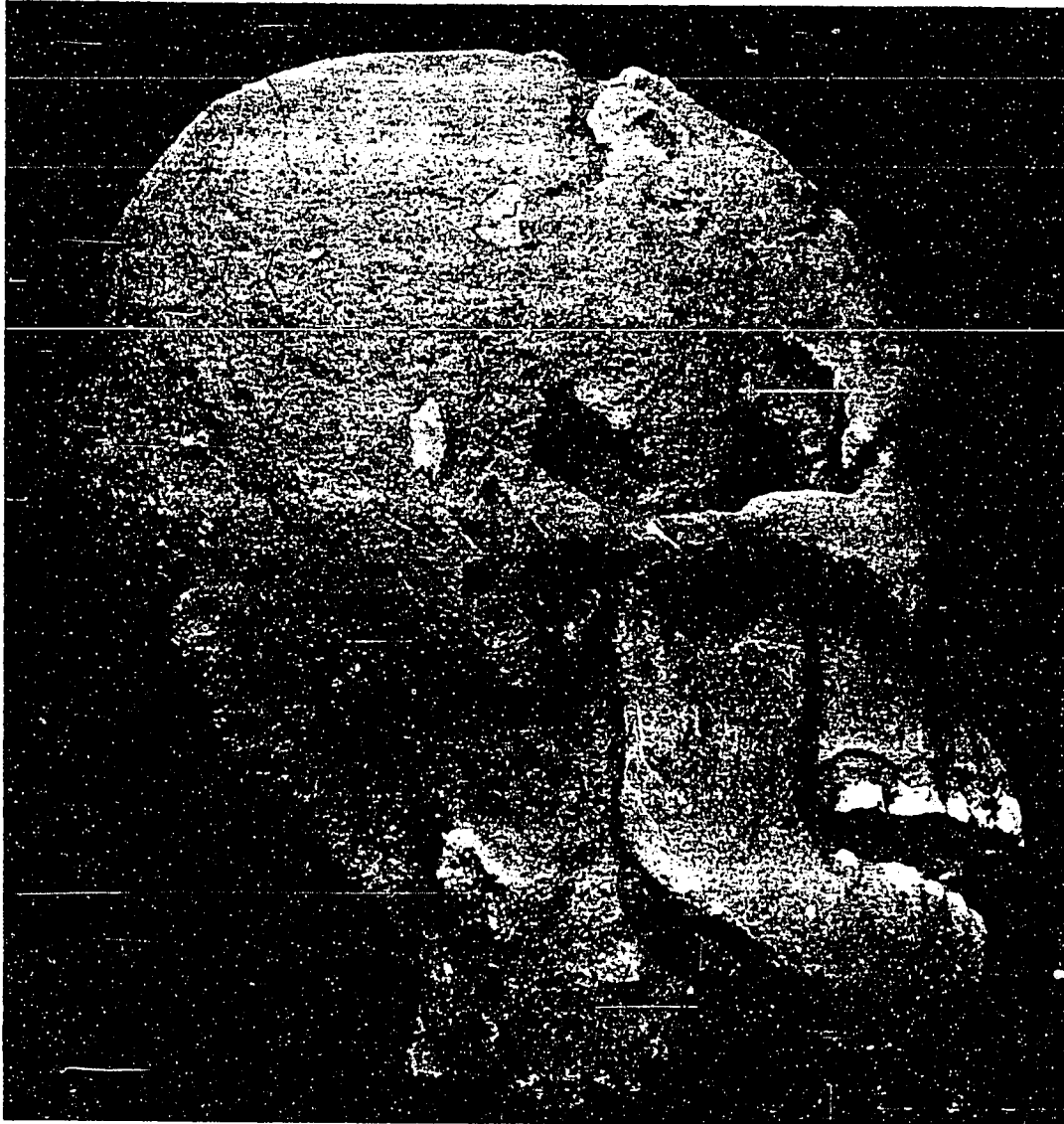

Pl.9:
Calcareous concretions on
Burial 108. Notice the
jade/greenstone pendant under mandible.
Insets demonstrate the problem of root intrusions on Burials
84 (right) and 90 (left).

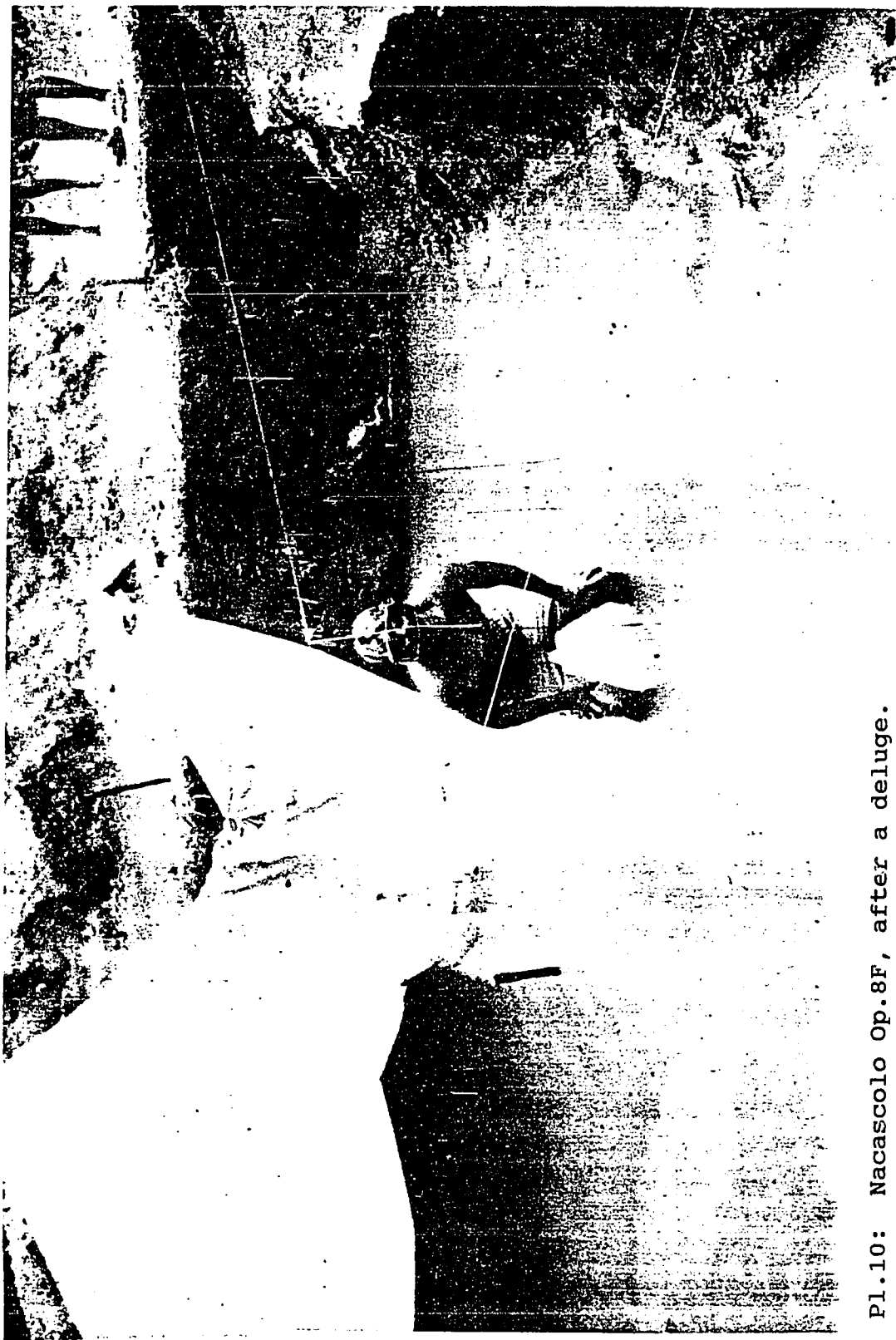

Pl.10: Nacascolo Op.8F, after a deluge.



Pl.11: Primary individuals placed on back in tightly flexed position: R. Bur.72, L. Bur.5.

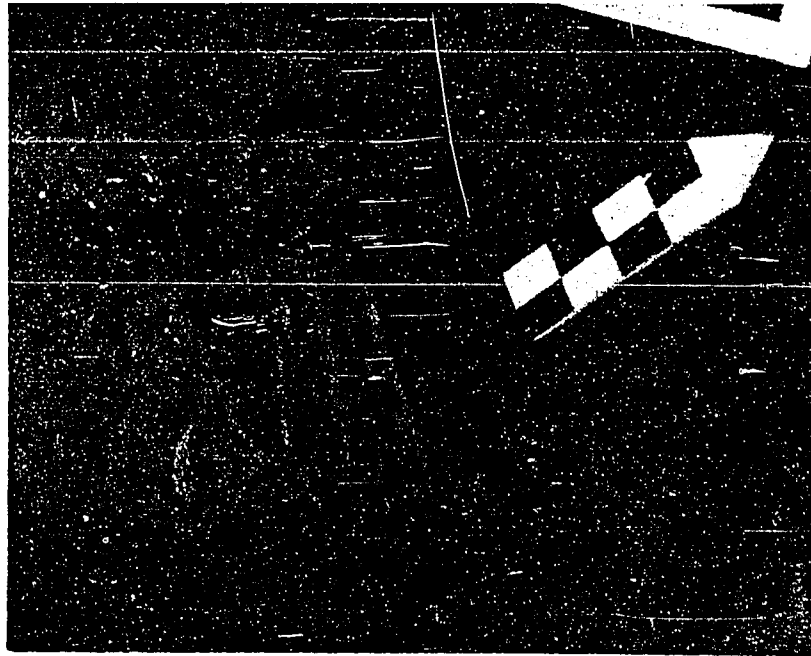

Pl.12:
 Burials placed on back, legs flexed
 to left: L. Bur.17, young adult, female;
 R. Bur.38, child @ 12 yrs..

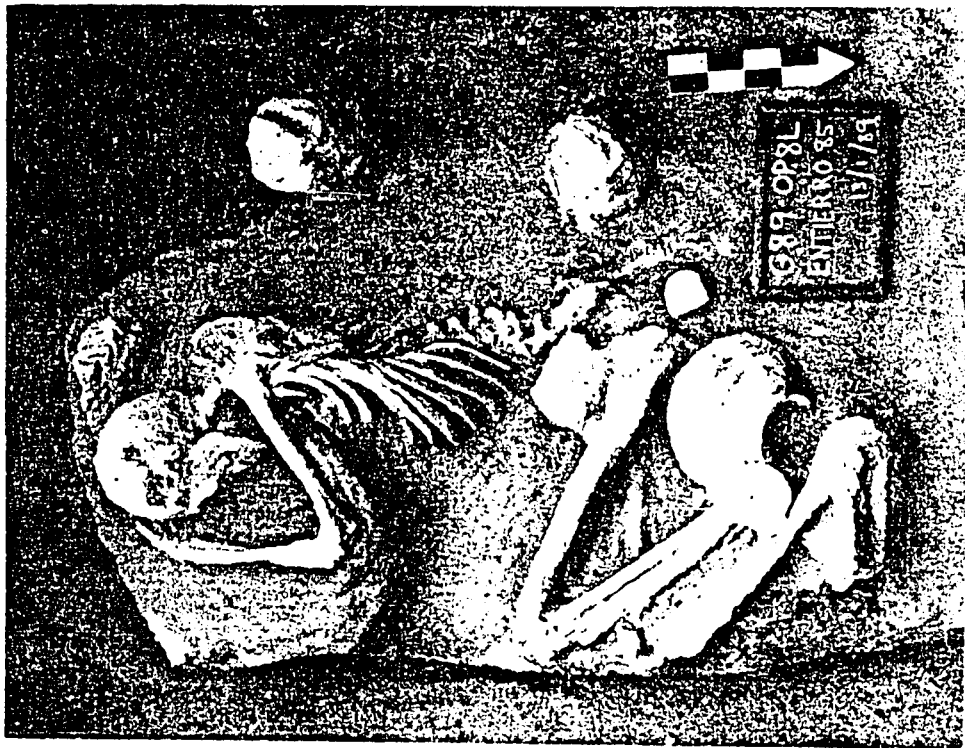

Pl.13:
Individuals flexed on right side:
L. Bur.85, male @ 20 yrs.;
R. Bur.95, 12-15 yrs.

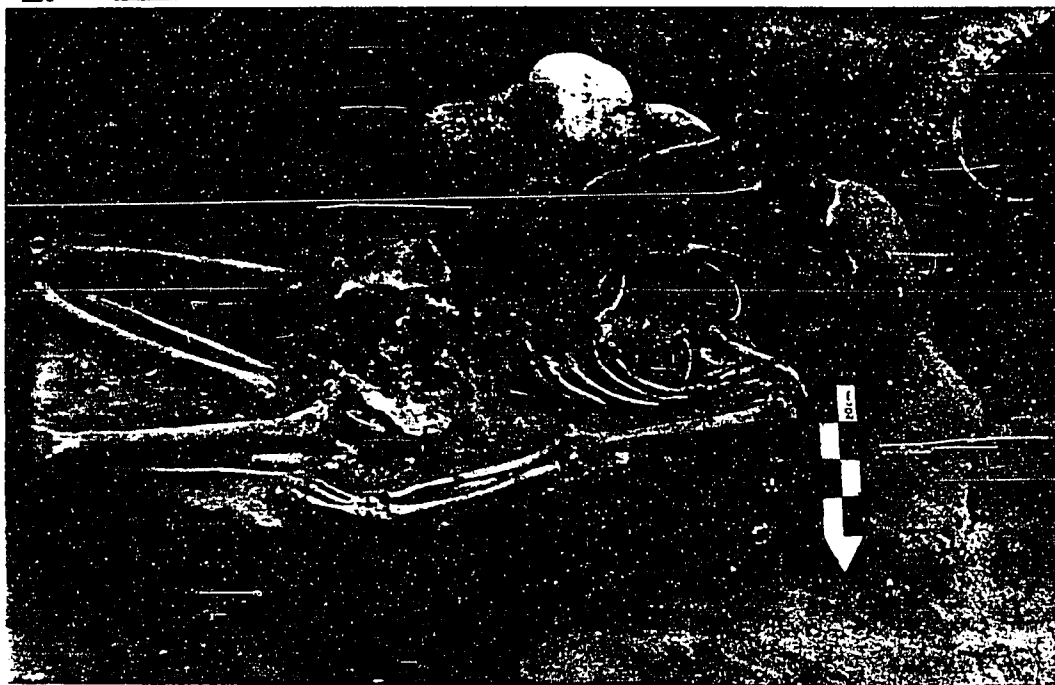
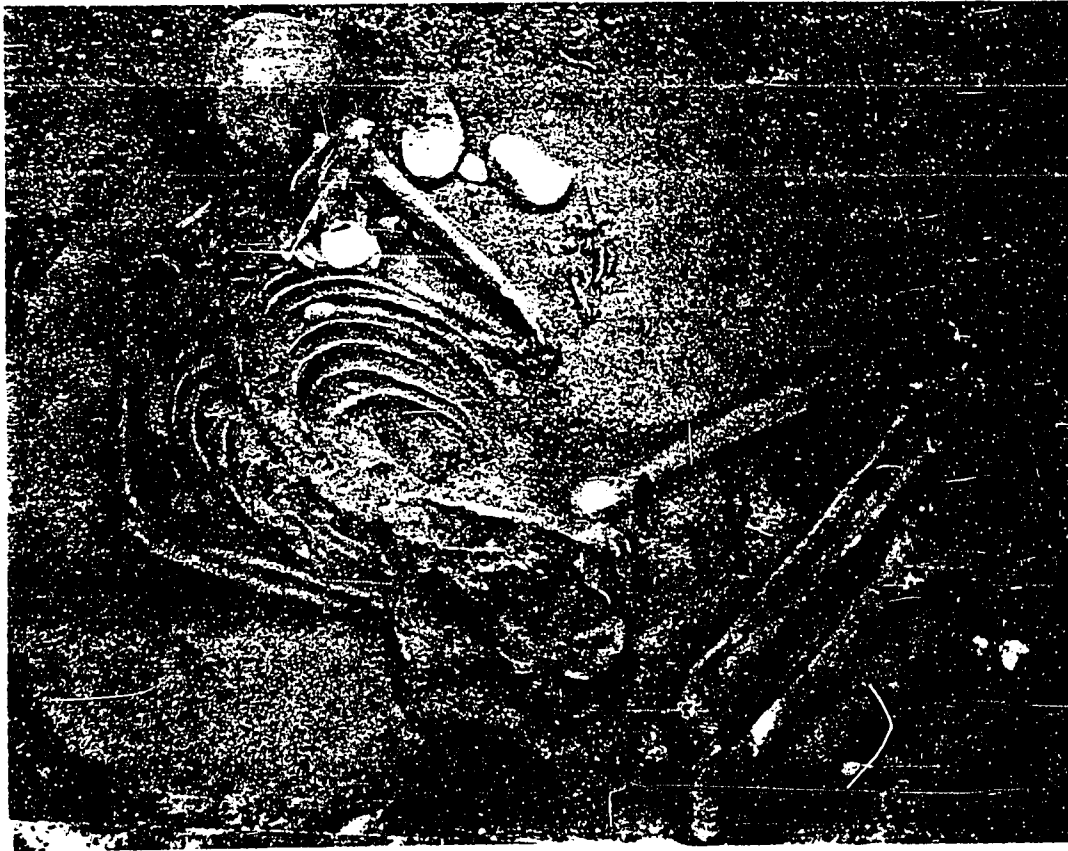

Pl.14: a) Semiflexed Burial 53, old adult, male; b) Burial 83, female 40-45 yrs., extended with legs tightly flexed.

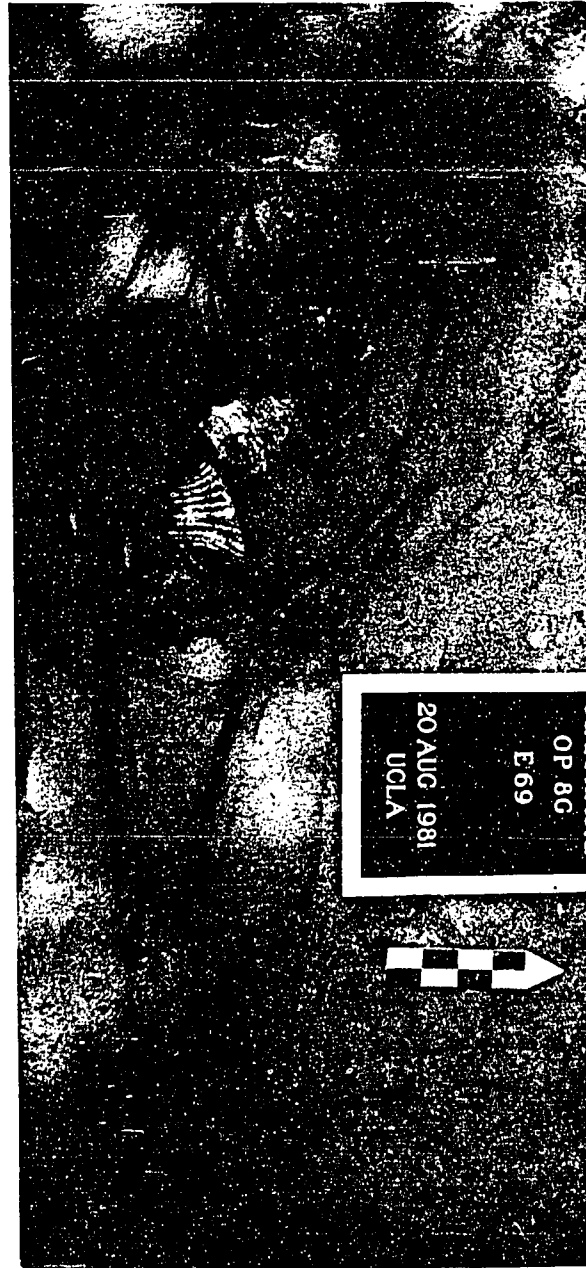

Pl.15: Extended individuals: Left, prone Burial 68, male, 17-19 yrs., modified human humeri to right of face; Right, supine Burial 69, male, 17-19 yrs. Two Strombus flanges on abdomen.



Pl.16: Area of infant burials: Inverted urn Burial 48; rocks above are burial fill over mano, metate, jade bead and infant burials.

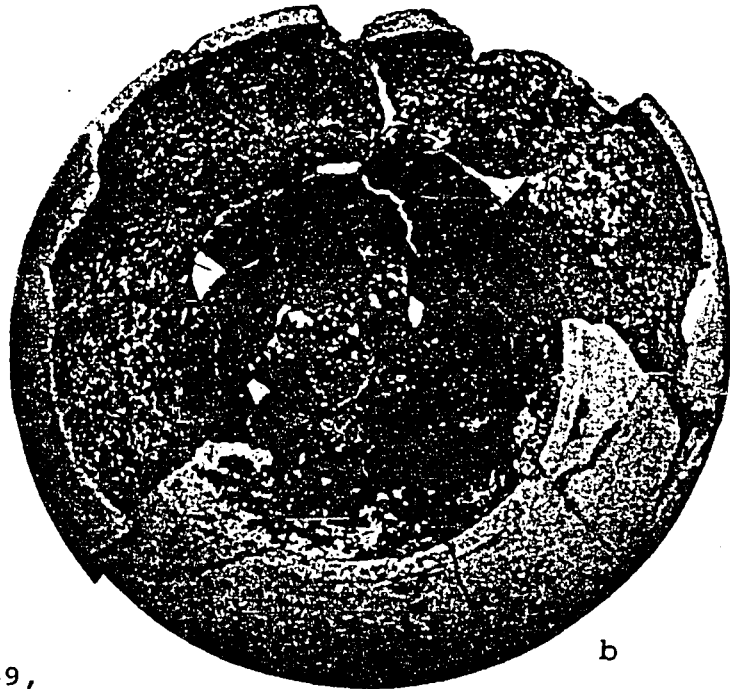

Pl.17:
a) Infant Burial 49,
Carrillo ray effigy vessel
capping burned burial urn (b).



Pl.18: a) Group Burial 1 bisects Burial 25;



b) Group Burial 4: 103,104,109.

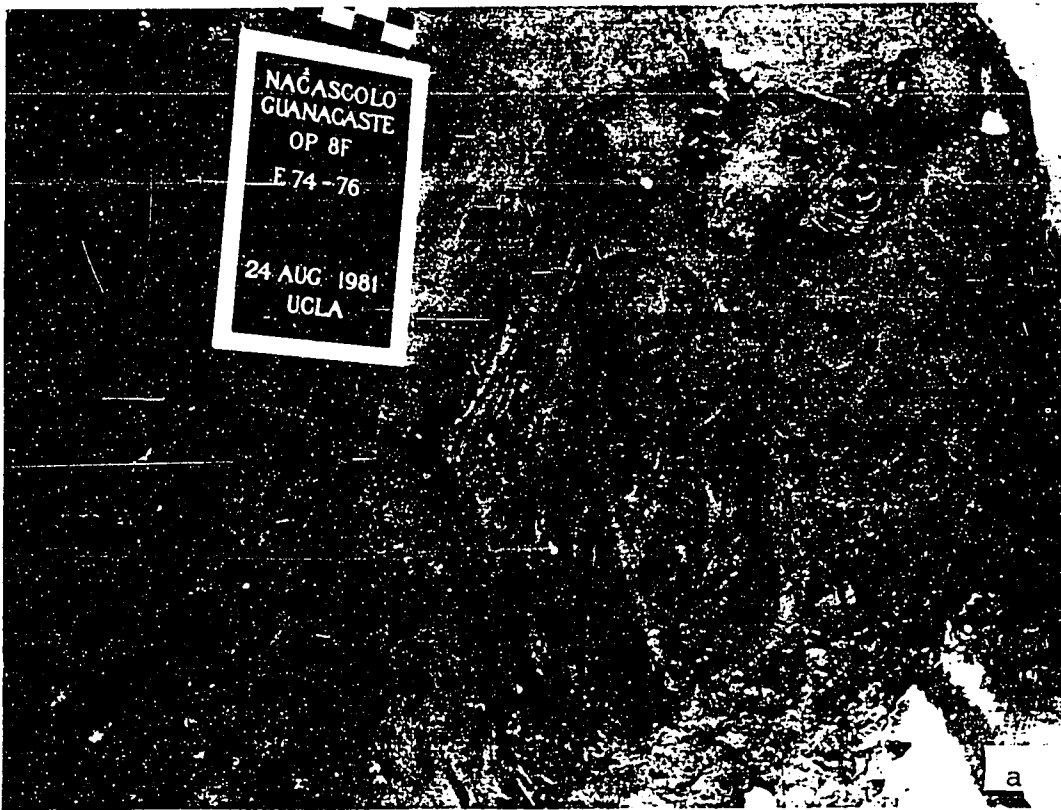

a

Pl.19 a)Group Burial 3 b)Group Burial 2

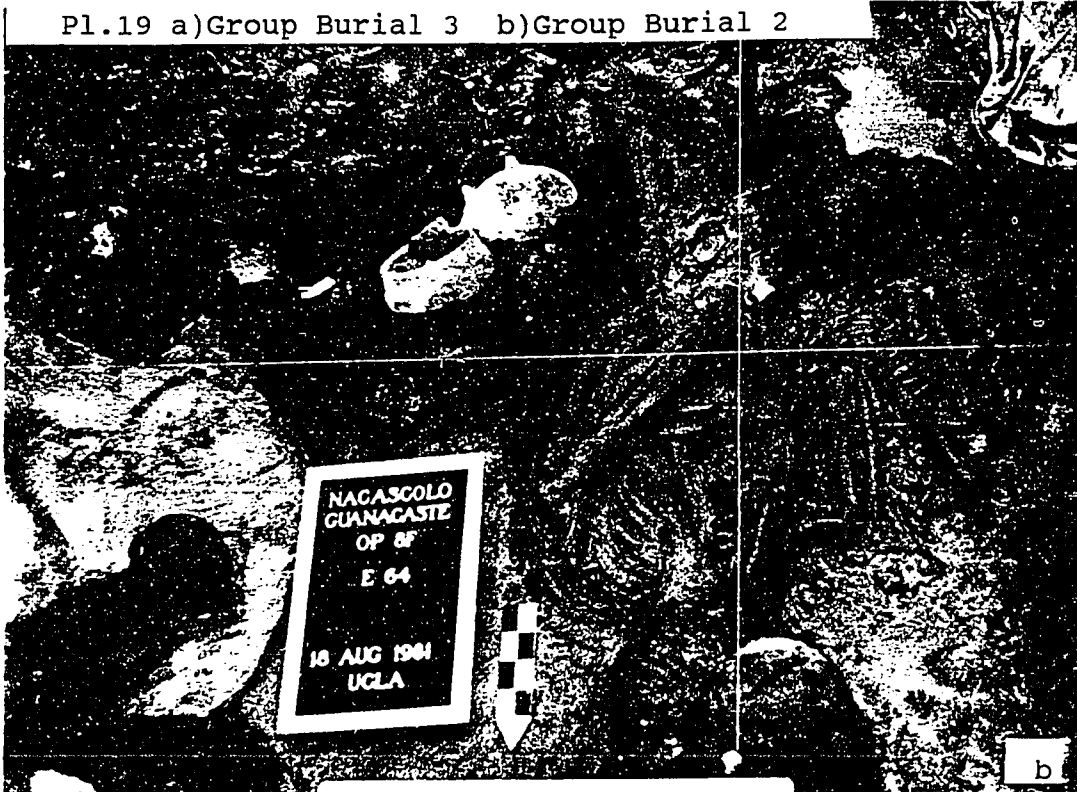

b

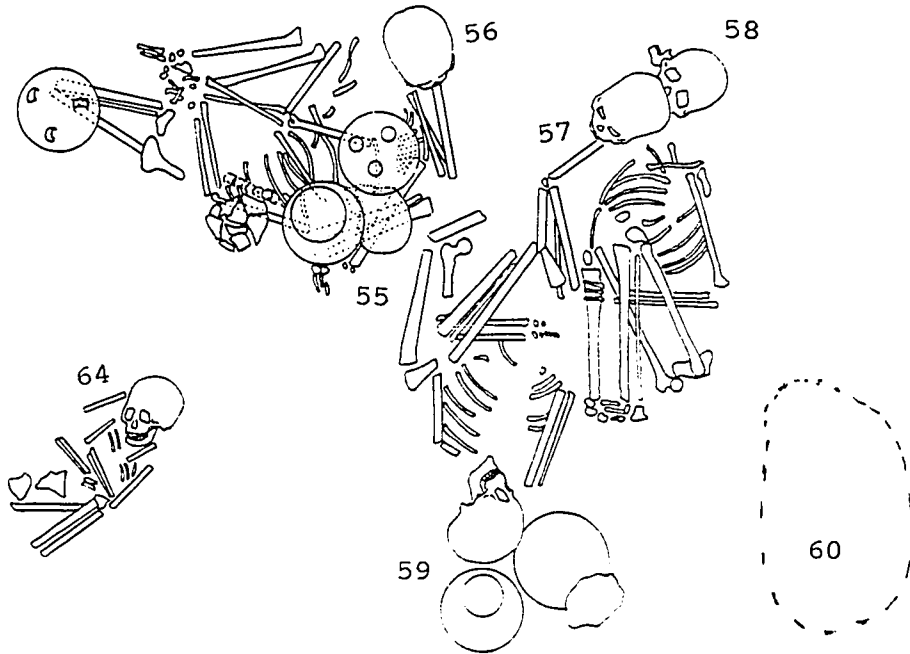

Pl.20: Group Burial 2: Burials 55, 56, 57, 58, 59.

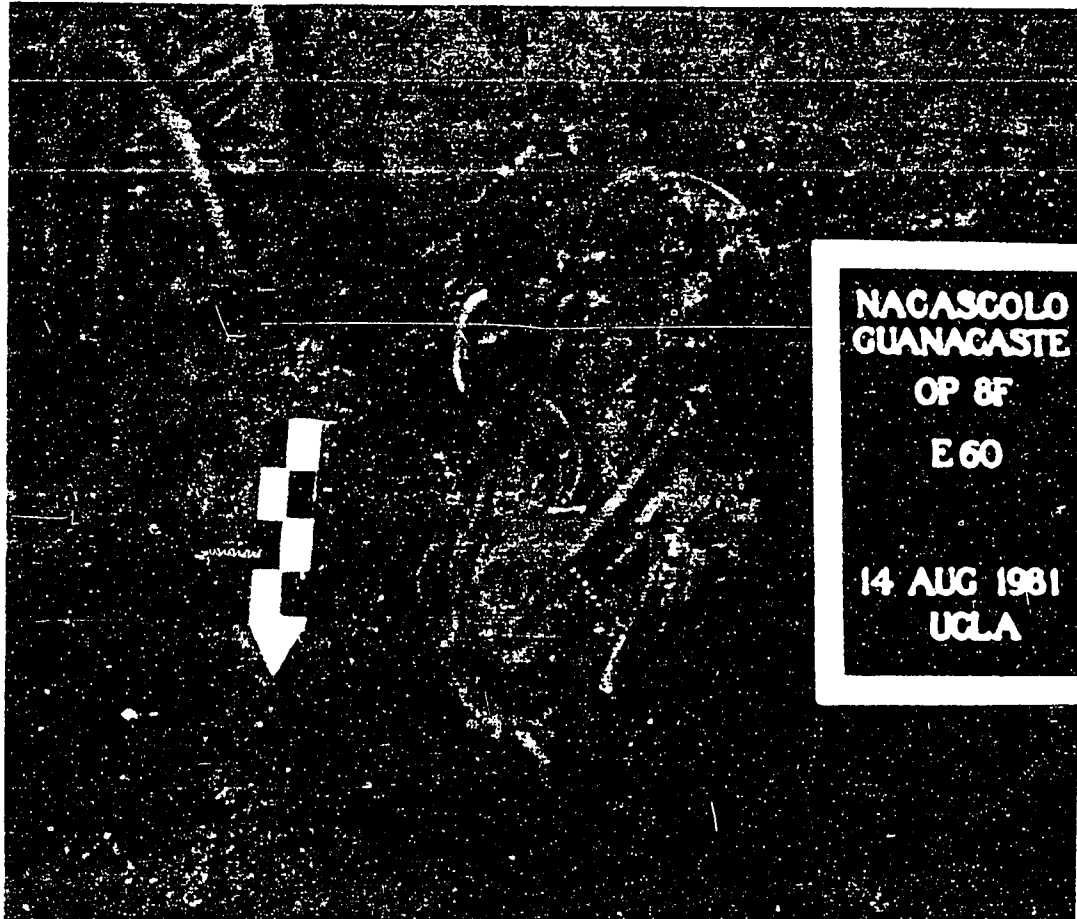

Pl.21: Secondary Burial 60, young adult, female?. Possibly part of Group Burial 2. Remains in upper left corner is Burial 57.

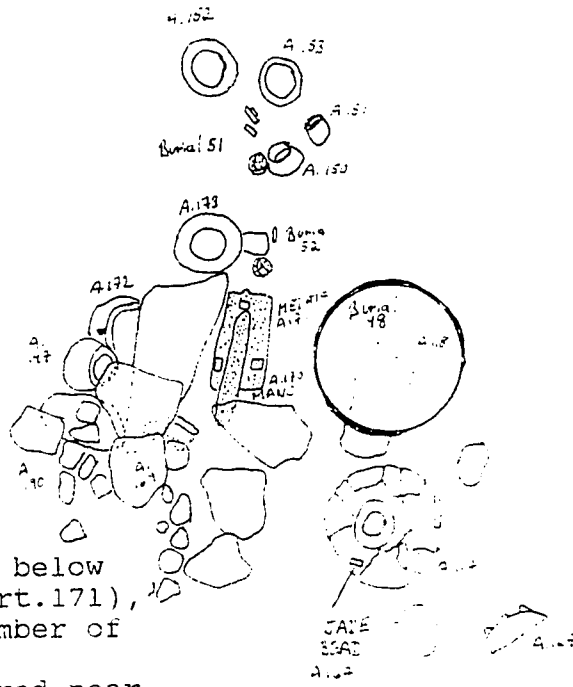
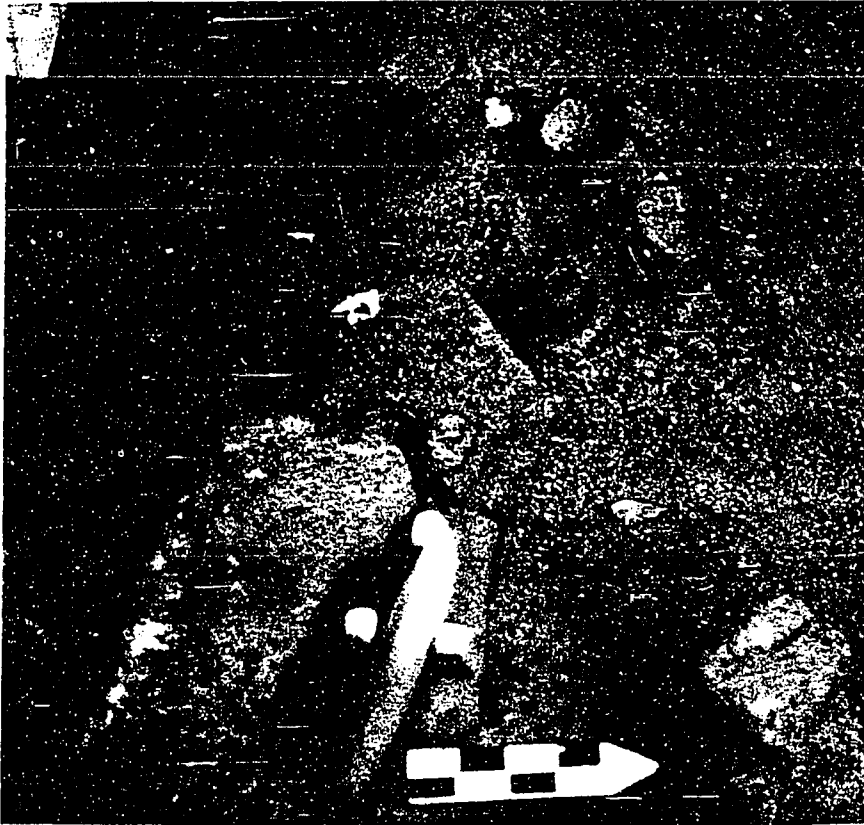

Pl.22:
 Area of infant burials found below
 mano (Art.170) and metate (Art.171),
 jade bead (Art. 168), and number of
 ceramic vessels. Infants
 (Burials 51 and 52) encountered near
 ceramics in background.

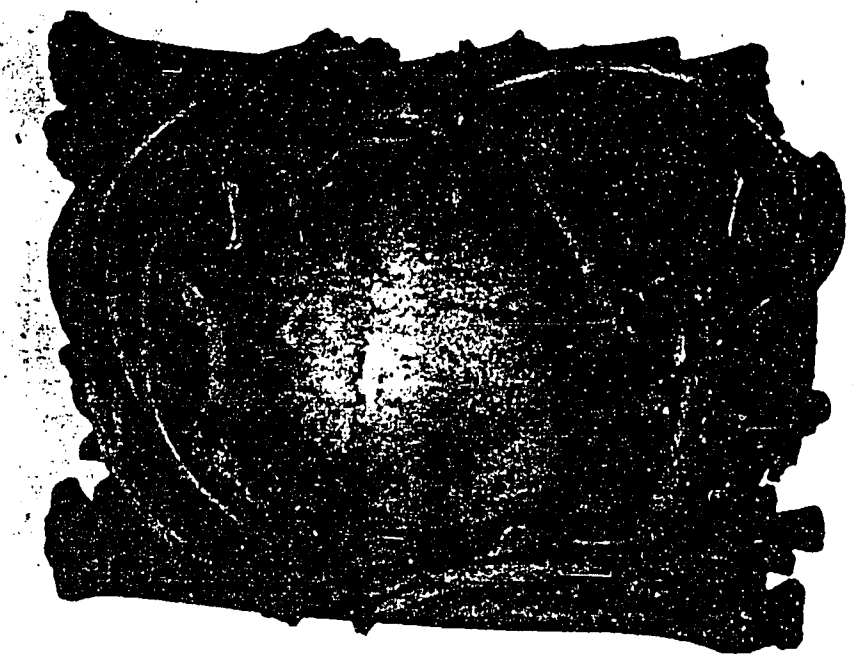
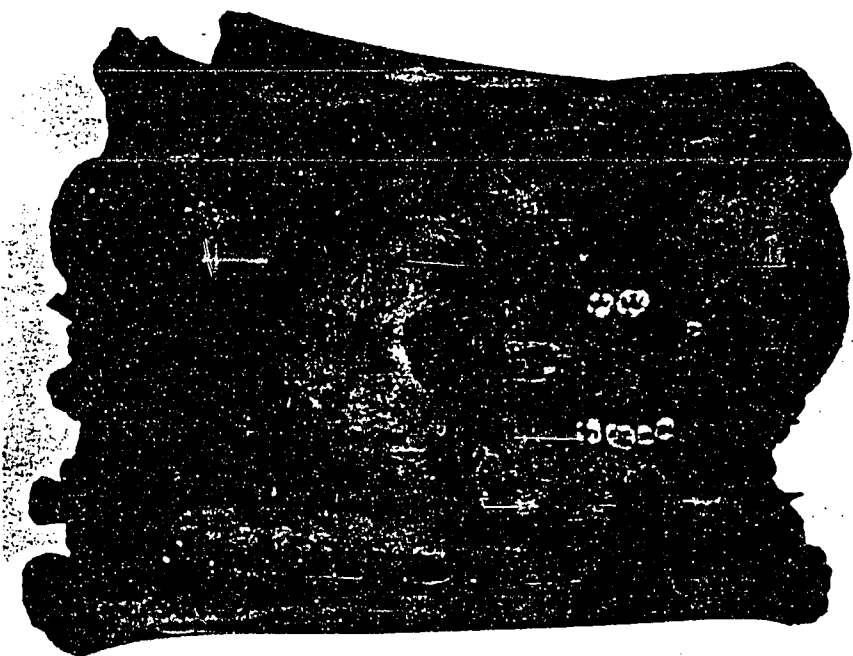

Pl. 23: Secondary burial from Isla Venado, Sitio Regla



Pl.24: From bottom left, Burial 14 cut by pit, Burial 26 extended individual in center, two disarticulated skulls to his right (Burial 20,21); to the right of photo, disarticulated long bones (Burial 6).



P1.25: Tightly flexed, young adult, female, Burial 39, cranium missing; isolated cranium of an infant (Burial 41) in background.

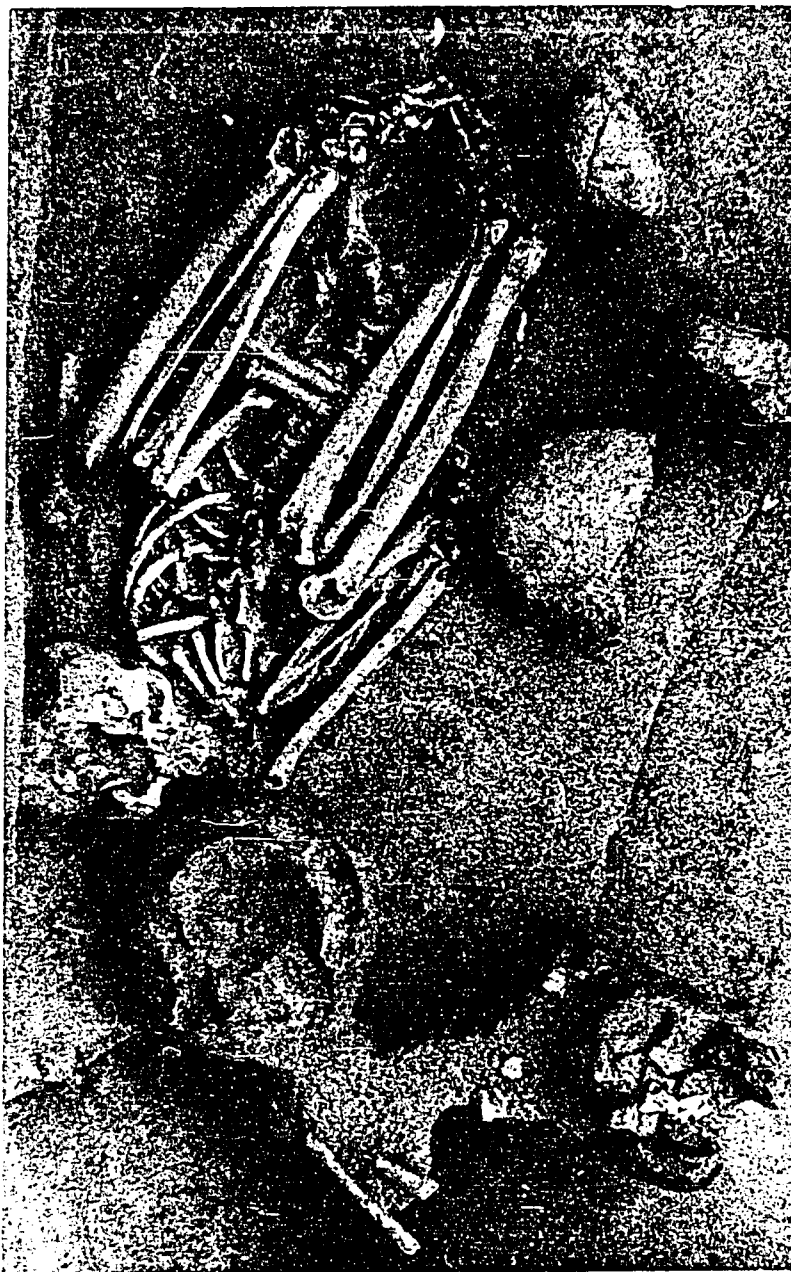

Pl.26: Burial 28 tightly flexed, middle adult, female, missing left hand, but hand bones found in vessel to its right; Left, fragmentary remains of Burial 16, approximately 6 yrs. old.

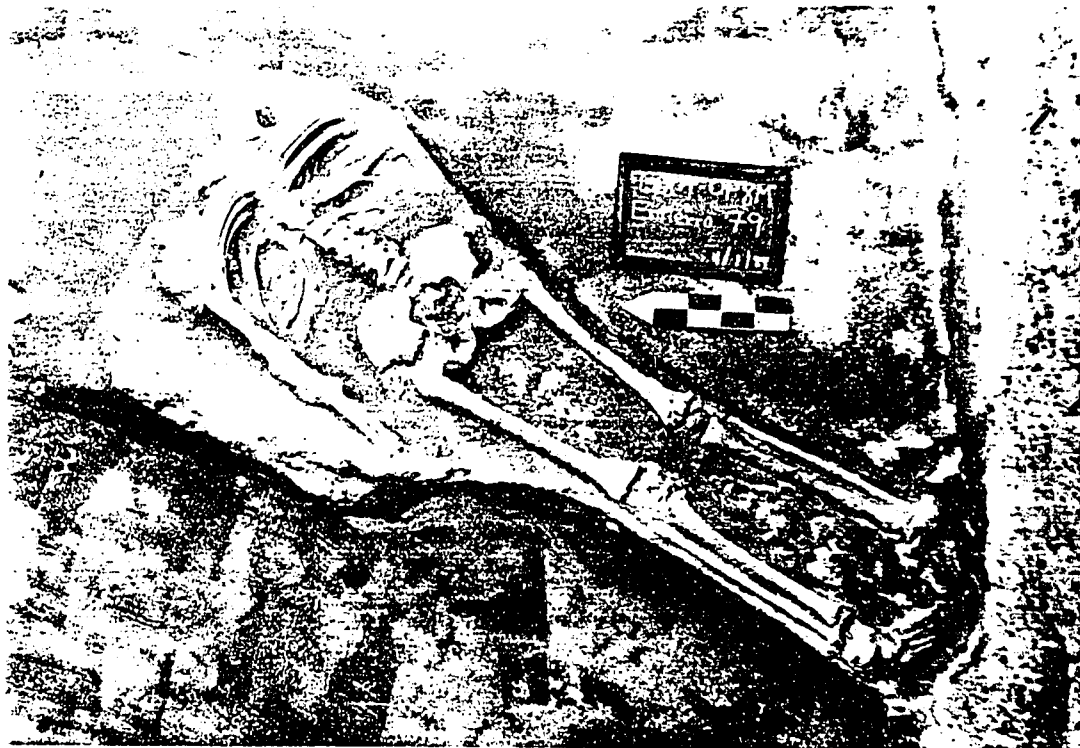

Pl.27: Evidence of mutilation and/or sacrifice. Burial 79, subadult, male, missing cranium, right arm and left hand.



Pl. 28: Top of Feature 18, area of secondary remains. Inset are Artifacts 300 and 301: a burned stone, and modified shell.



Pl. 29: Feature 18, secondary bone groups.

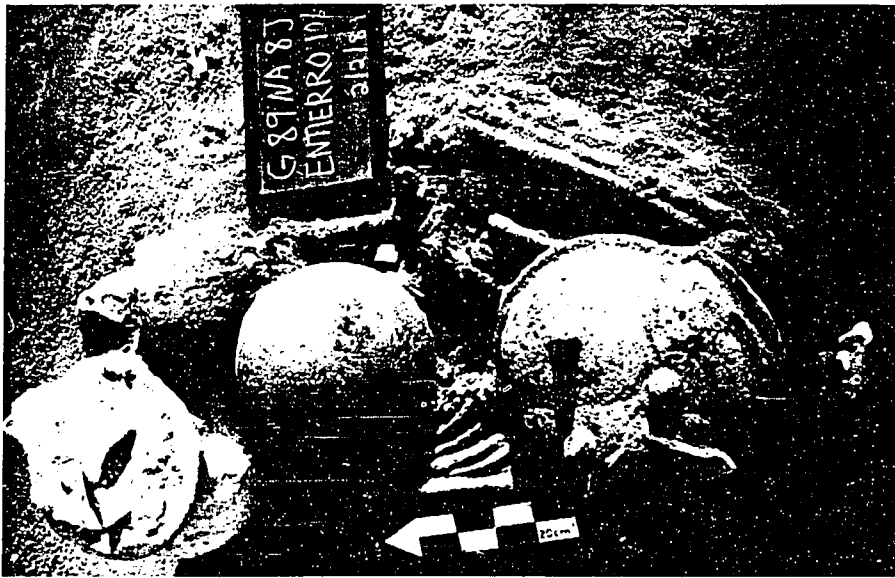

Pl.30: Bone groups "E" "F" and "G" of Feature 18; semiarticulated remains and Burial 102 found below these secondary remains.

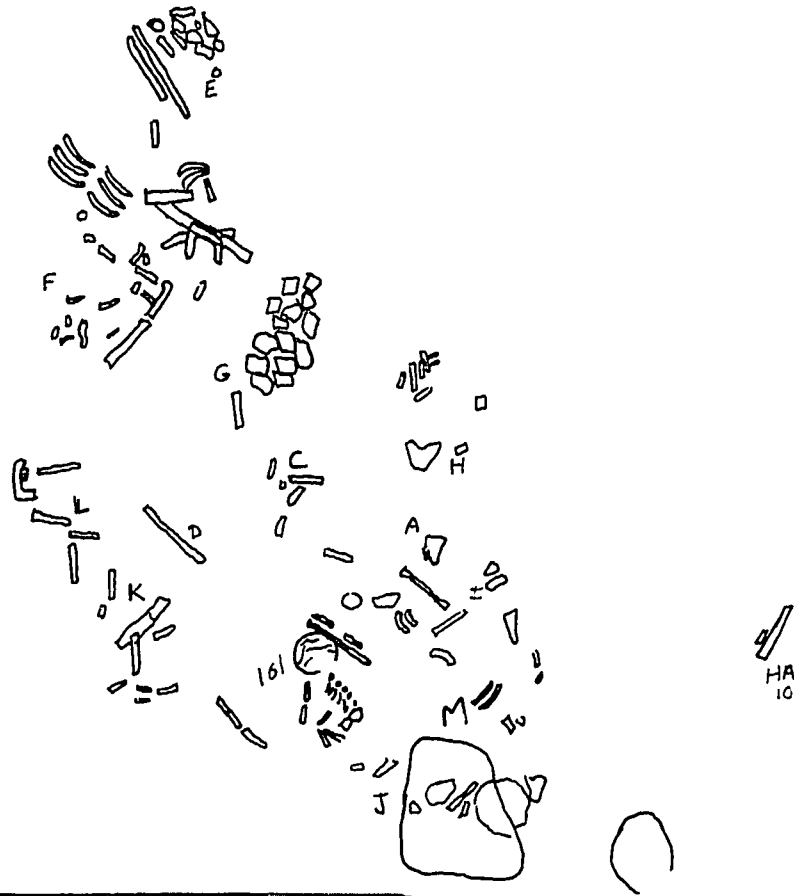

Pl.31: Drawing of bone groups of Feature 18. Photo is Burial 101 and bone groups "J" and "M"

Enamel Hypoplasia
Maxilla, Burial 108



Burial 80
Possible fracture and/or
osteomyelitis

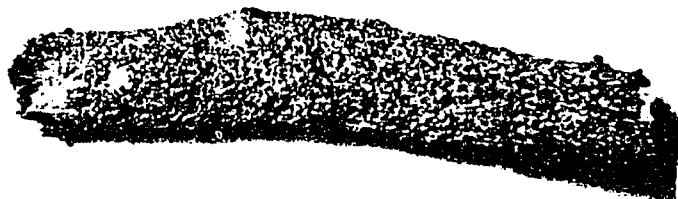

"B"
Identified fracture

Pl.32: Paleopathology

Burial 103
Right clavicle, inferior view, tendon insertion

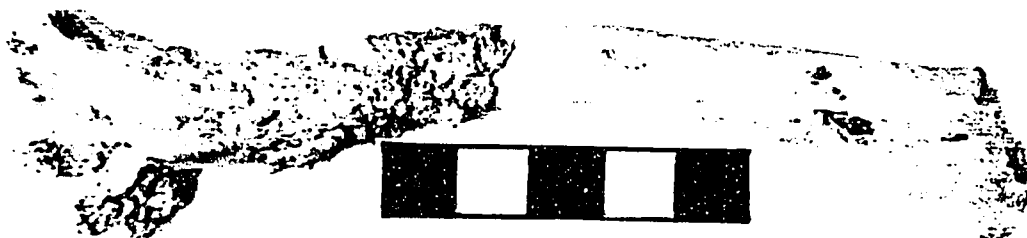

Tendon insertion, close-up

Odd-shaped molar
and Extra cusp, Bones "I"

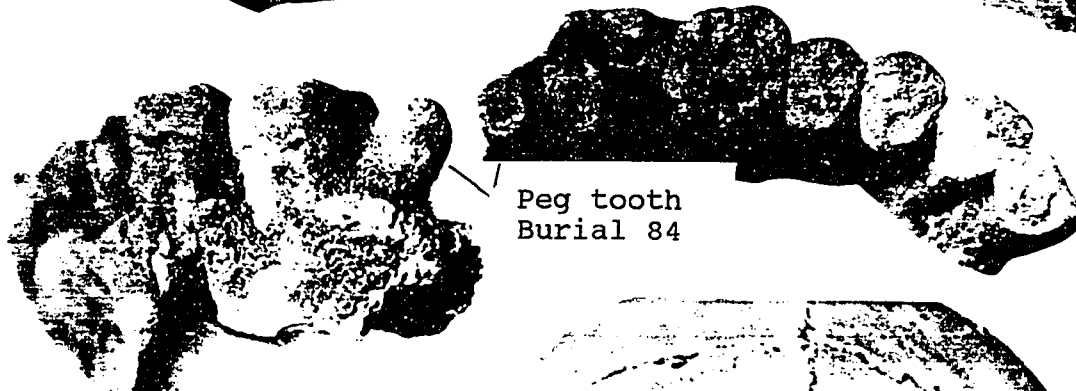

Peg tooth
Burial 84

Extra Metopic Suture
Burial 105



Pl.33: Interesting anomalies of skeletal remains. Op.8A-M.

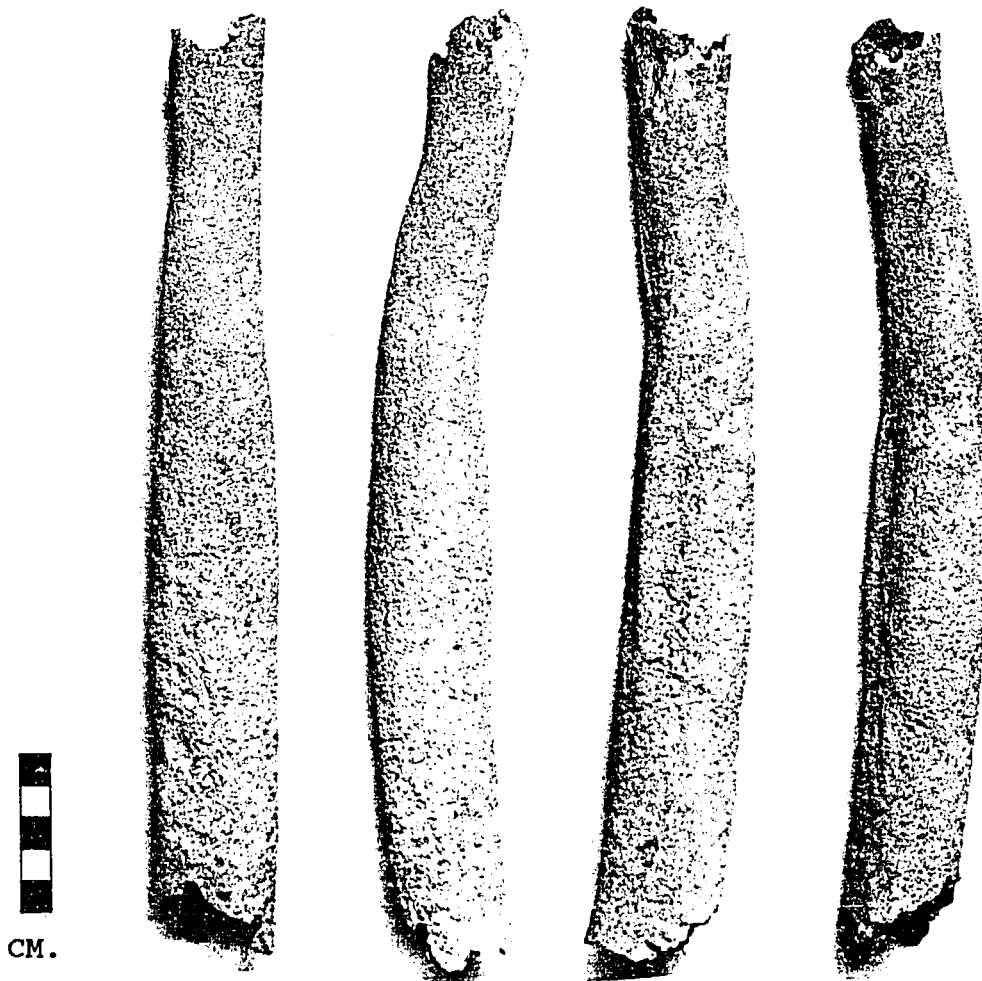

Pl.34: Possible treponema, Burial 82, left femur.
A) AP view, anterior surface.
B) ML view, lateral surface.
C) AP view, posterior surface.
D) ML view, medial surface

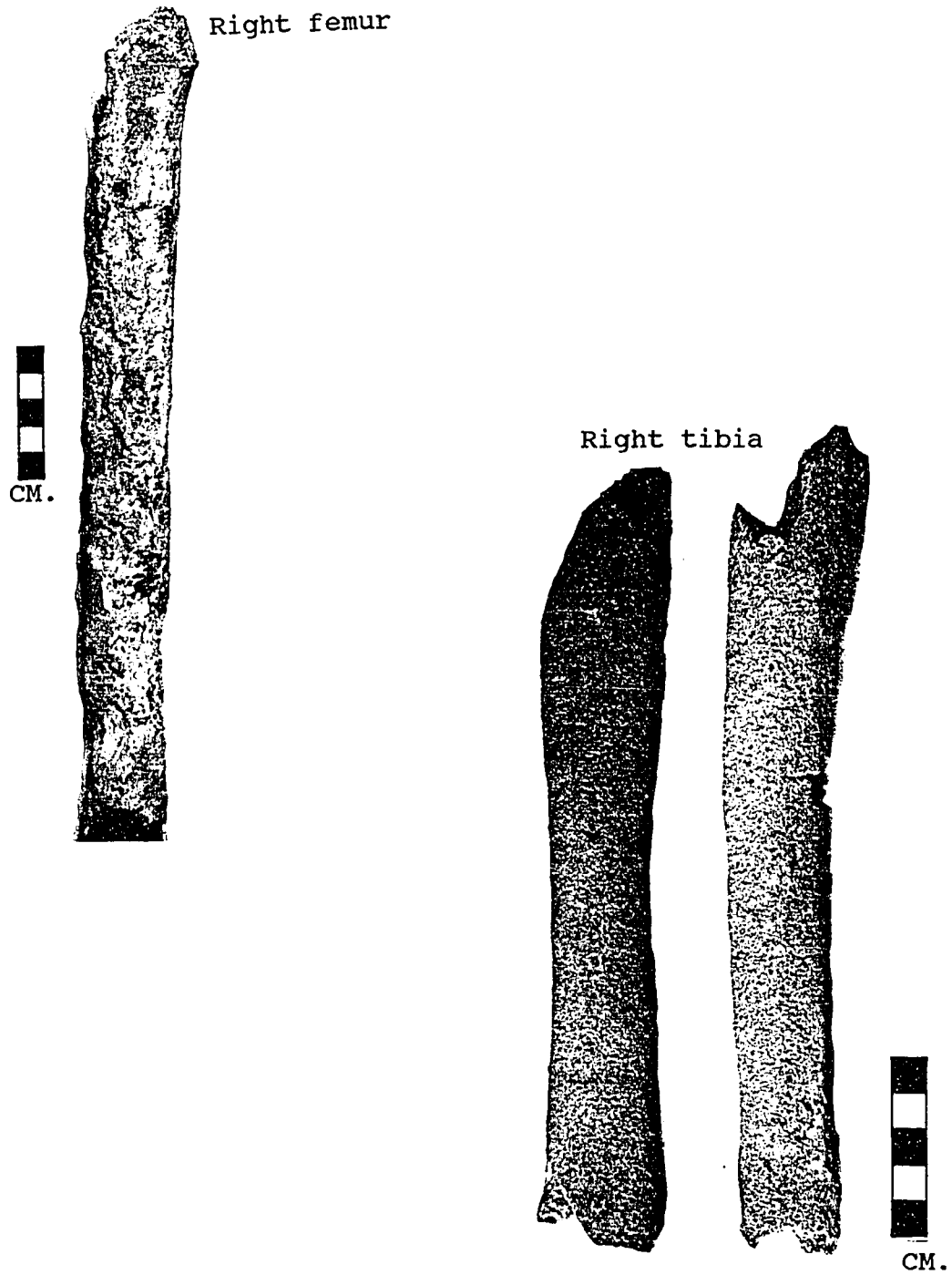

Pl.35: Possible treponema, Burial 82
Top: Right femur, ML view, medial surface
Bottom: Right tibia
A) ML view, lateral surface.
B) ML view, medial surface.

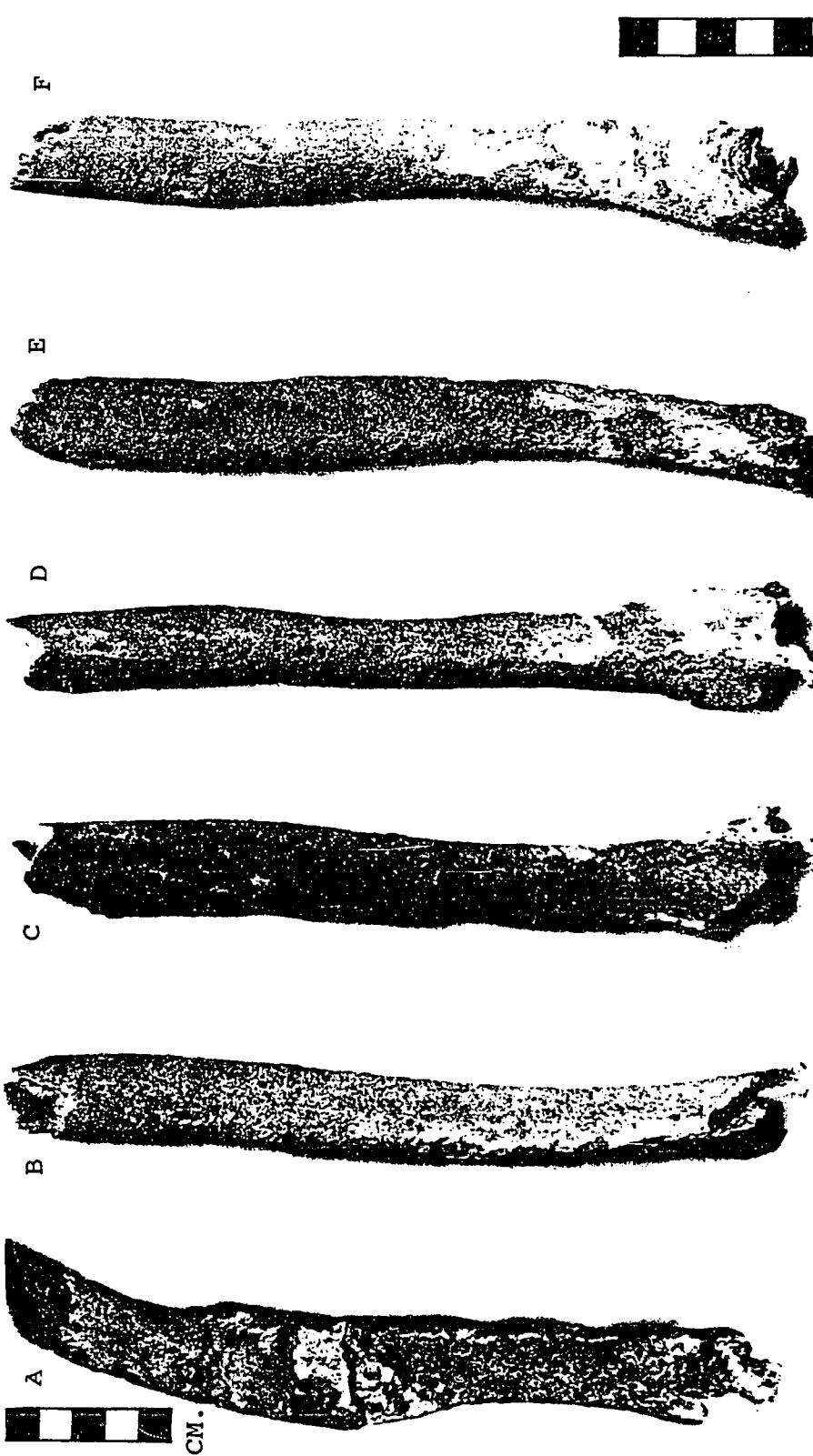

Pl. 36: Possible treponema, Burial 82
 A) Right humerus, ML view, medial surface
 B) Left humerus, ML view, medial surface
 C) Left humerus, AP view, anterior surface
 D) Left humerus, AP view, anterior surface
 E) Left humerus, ML view, lateral surface



Pl.37: Shell and sherd burial fill, Burial 85.



Pl.38: Op.8A-E, Feature 1, Concentration of rocks and carbon, partially removed, revealing concentration of grave offerings in tomb fill associated with Burial 34.

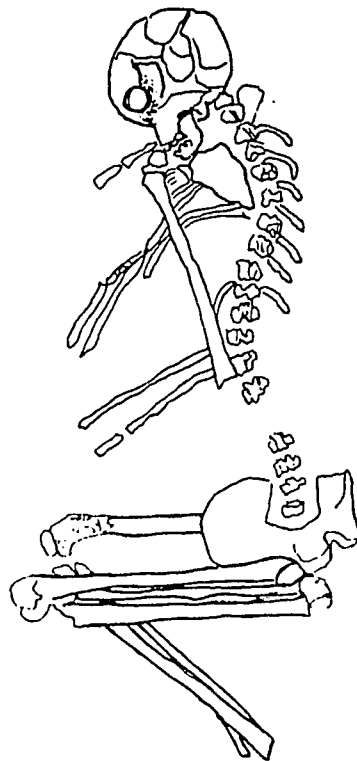

Pl.39: Burial 34, middle adult female, below Feature 1 and grave offerings shown in previous plate (38). Notice additional metates and vessels placed over burial.



Pl.40: Top: Excavation of Feature 13 ovens. Notice (A) garrobo skeleton in top photo, bottom left. Bottom: ovens after removal of overburden.

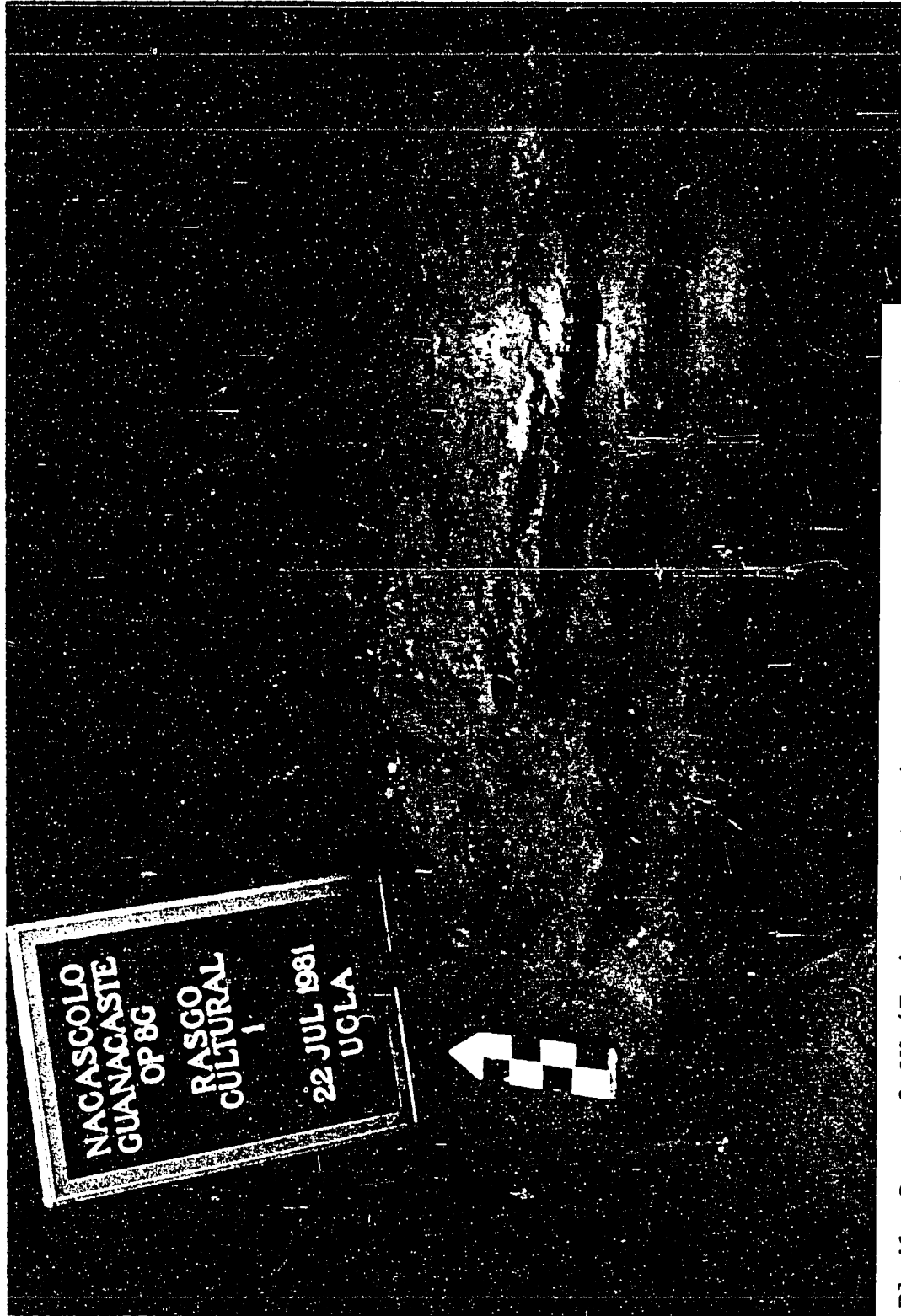

Pl.41: Oven of 8H (Feature 1, 1981).



Pl.42: Several types of ovens found around Nacascolo.

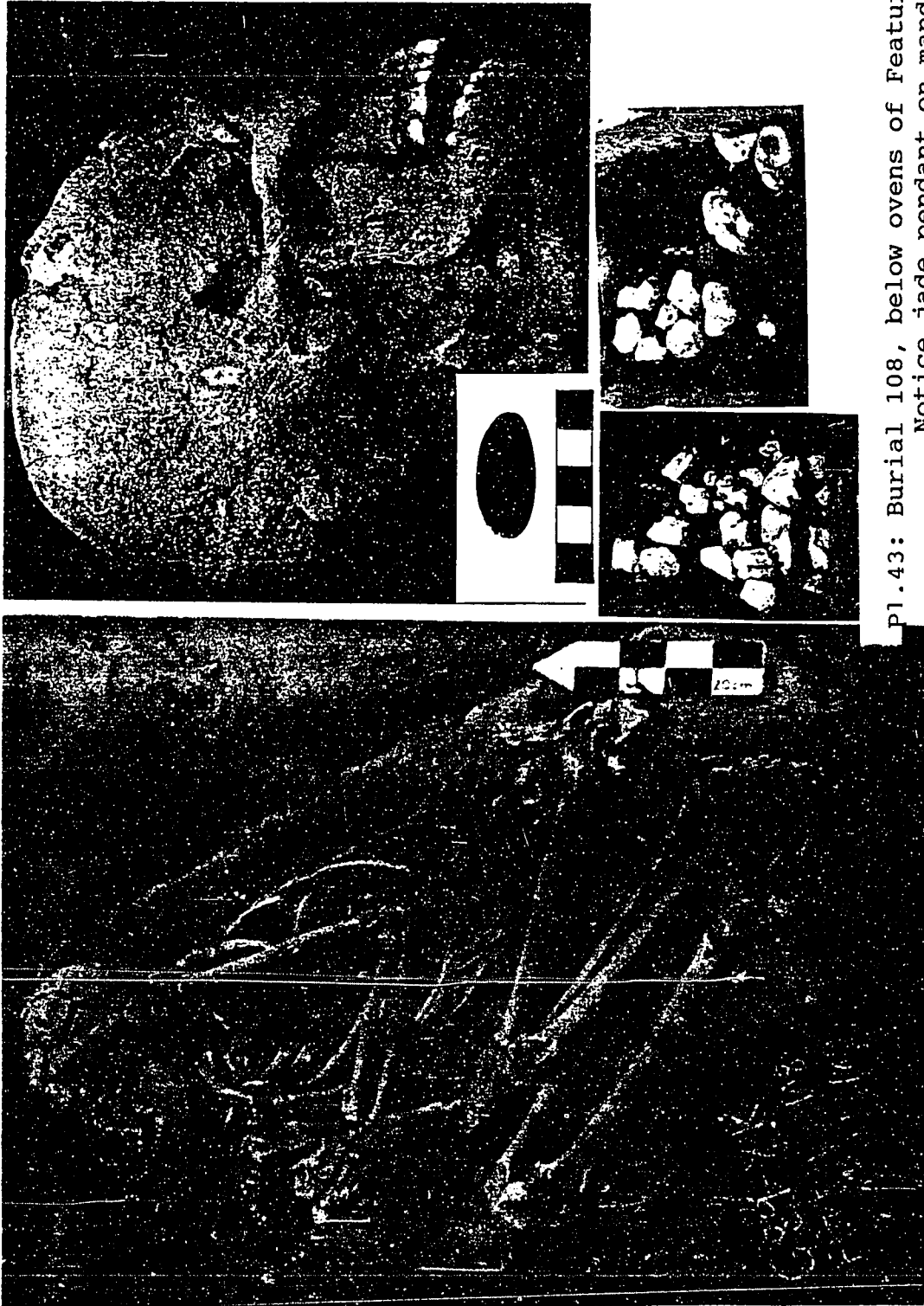

Pl. 43: Burial 108, below ovens of Feature 13
Notice jade pendant on mandible.



Pl.44: Shell (Ostrea) floor, Burial 105 on top.

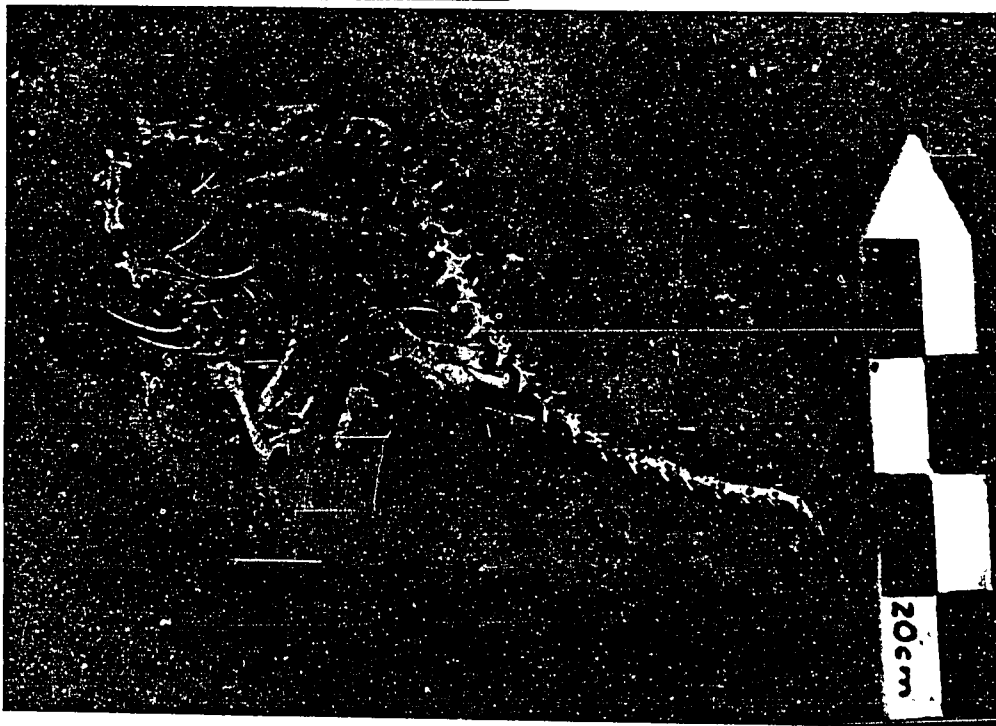

Pl.45: Animal ceremonialism expressed in Nacascolo beach cemetery (Op.8A-M). Top: Canis sp.; Below: Ctenosaura similis.

NACASCOLO
GUANACASTE
OP 8G
RASCOS
CULTURALES
8, 9, 10
2 AUG 1981
UCLA

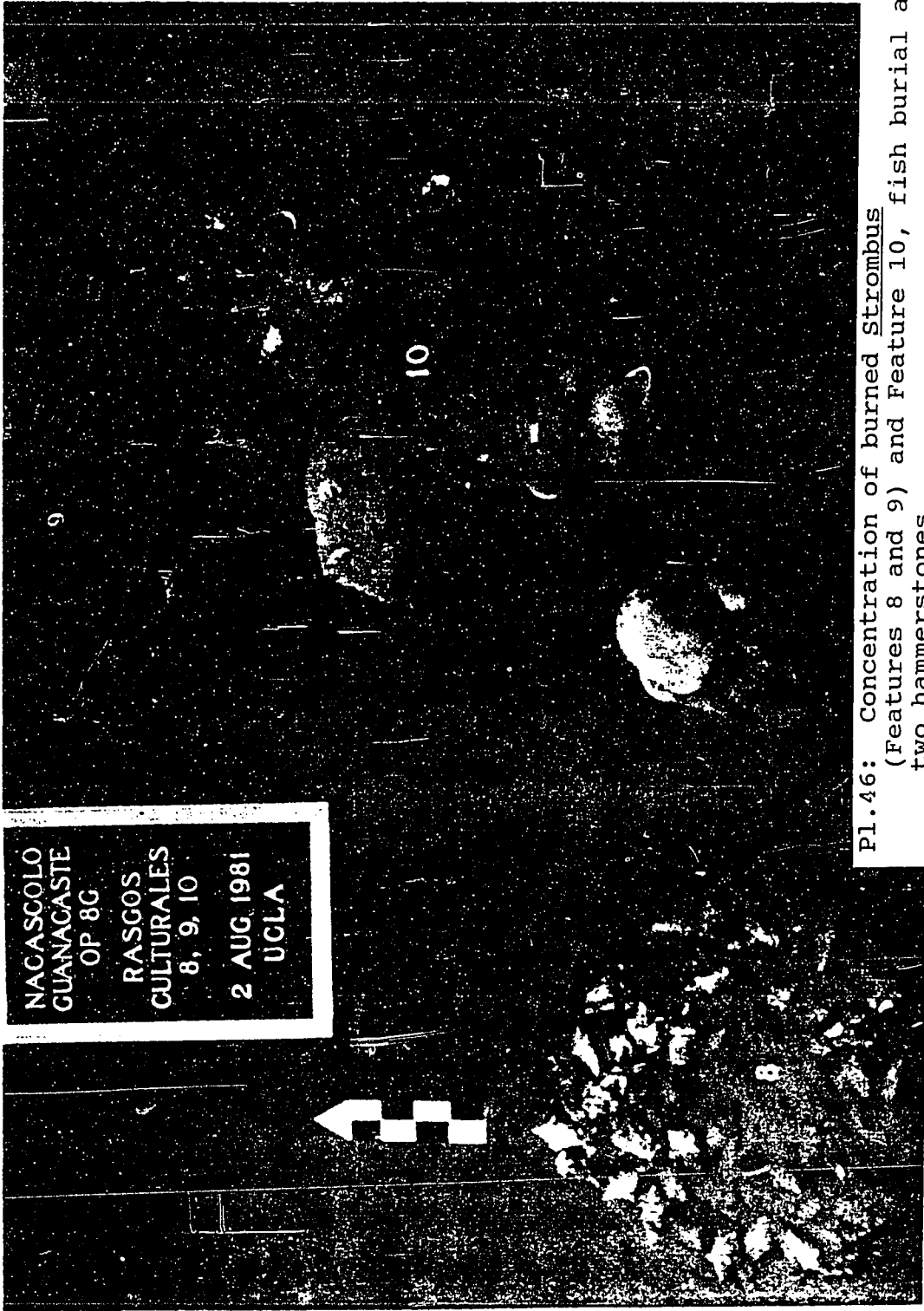

Pl. 46: Concentration of burned Strombus
(Features 8 and 9) and Feature 10, fish burial and
two hammerstones.



Pl.47: Vessel shapes, large vessels

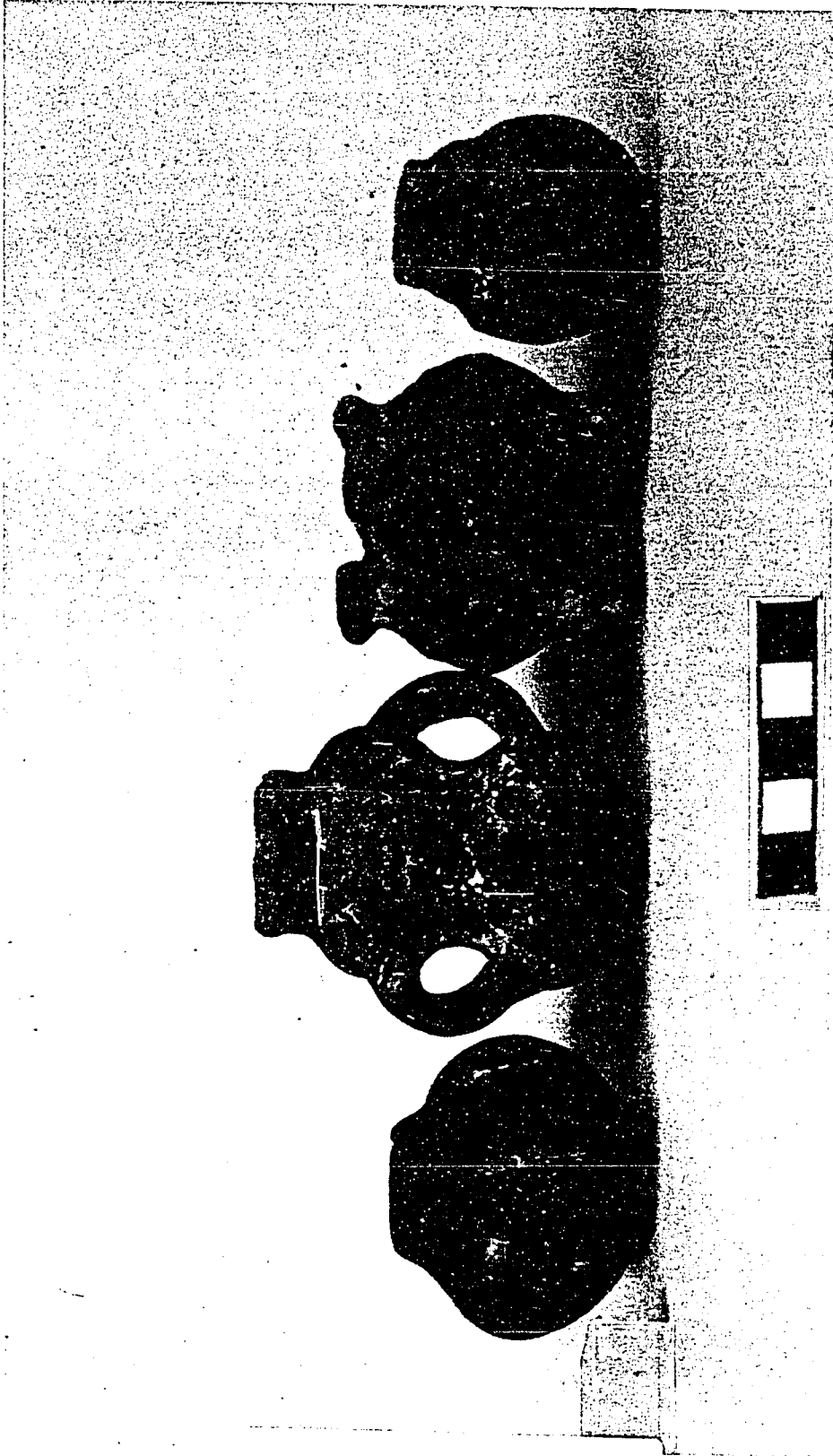

Pl.48: Miniature vessels; A) Espejo Black, Art.111, B)
Piches Red, Art.5; C and D (Arts.215 and 247) Urruela Red.



Pl. 49 a)Espejo Black; b) Ampompua Modelled

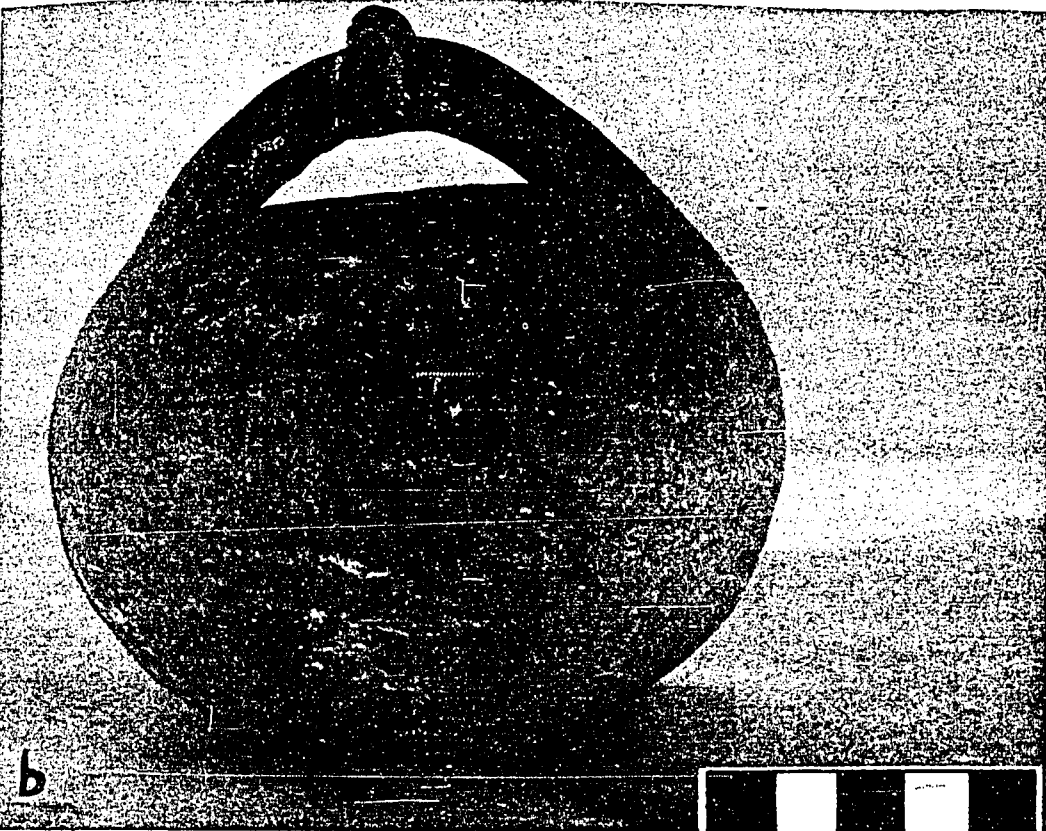

Pl.50 a) unknown type, crude ware; b) Yayal Brown

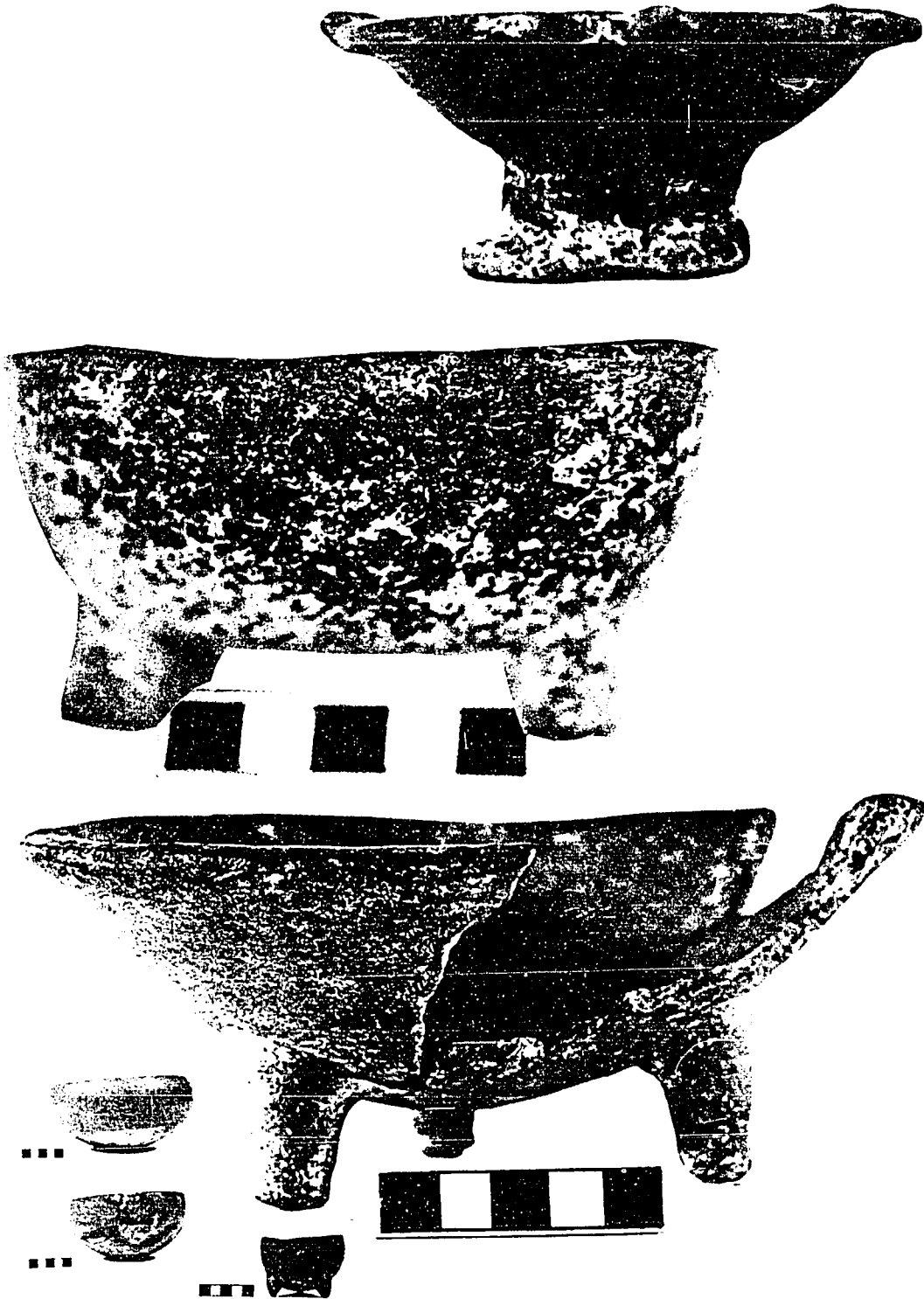

Pl.51 a) unknown type, almost purple with incised cross;
b) c,d, e all Juanilla Red on Beige.

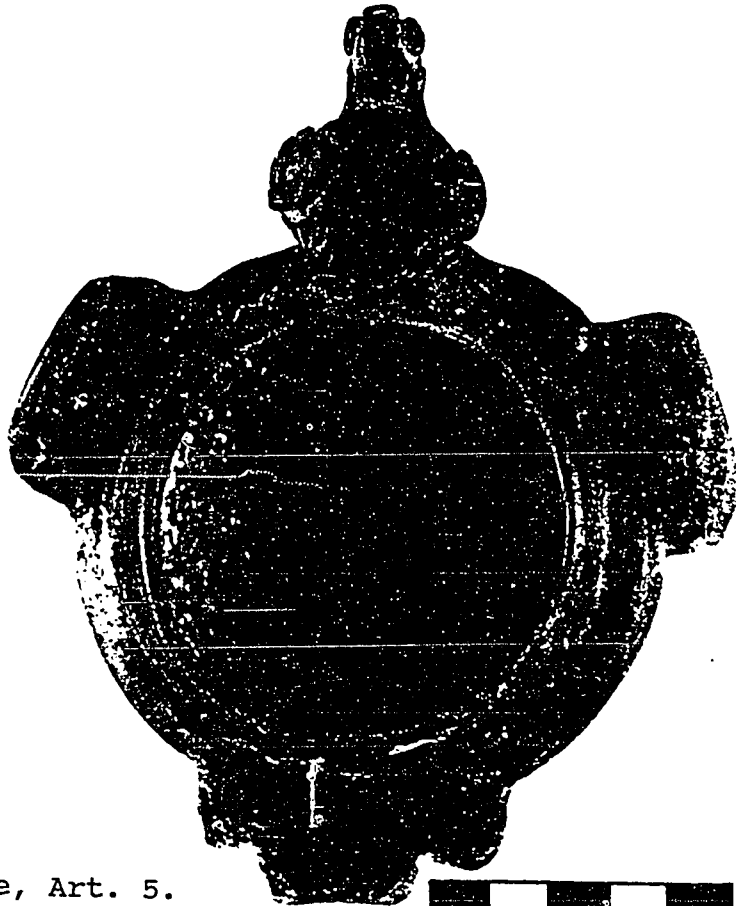
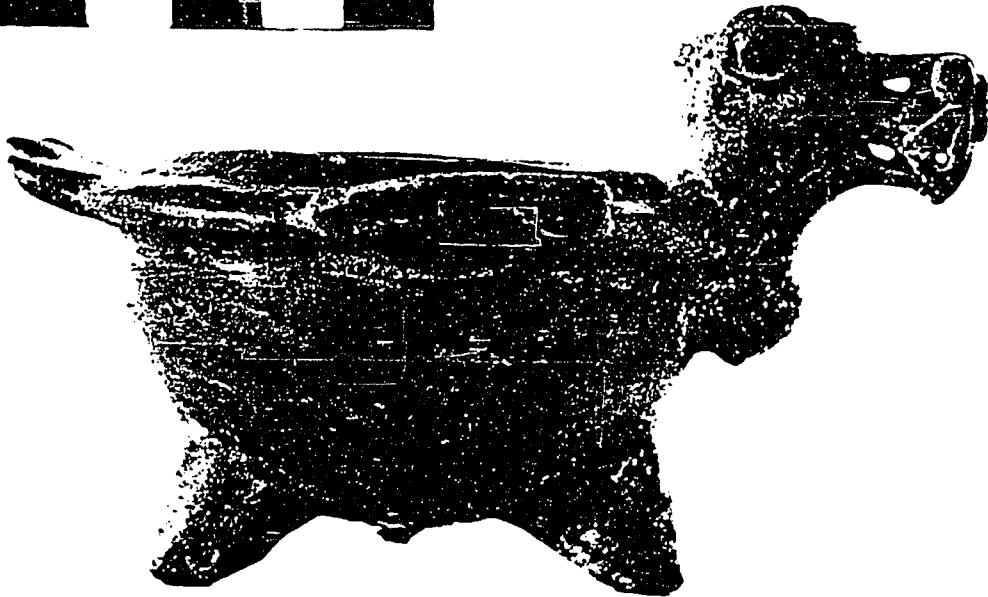

Pl.52
Fregitidae, Art. 5.
Piches Red zoomorph vessel,



Pl.53: Piches Red zoomorph vessel Lenguado (Bothidae).



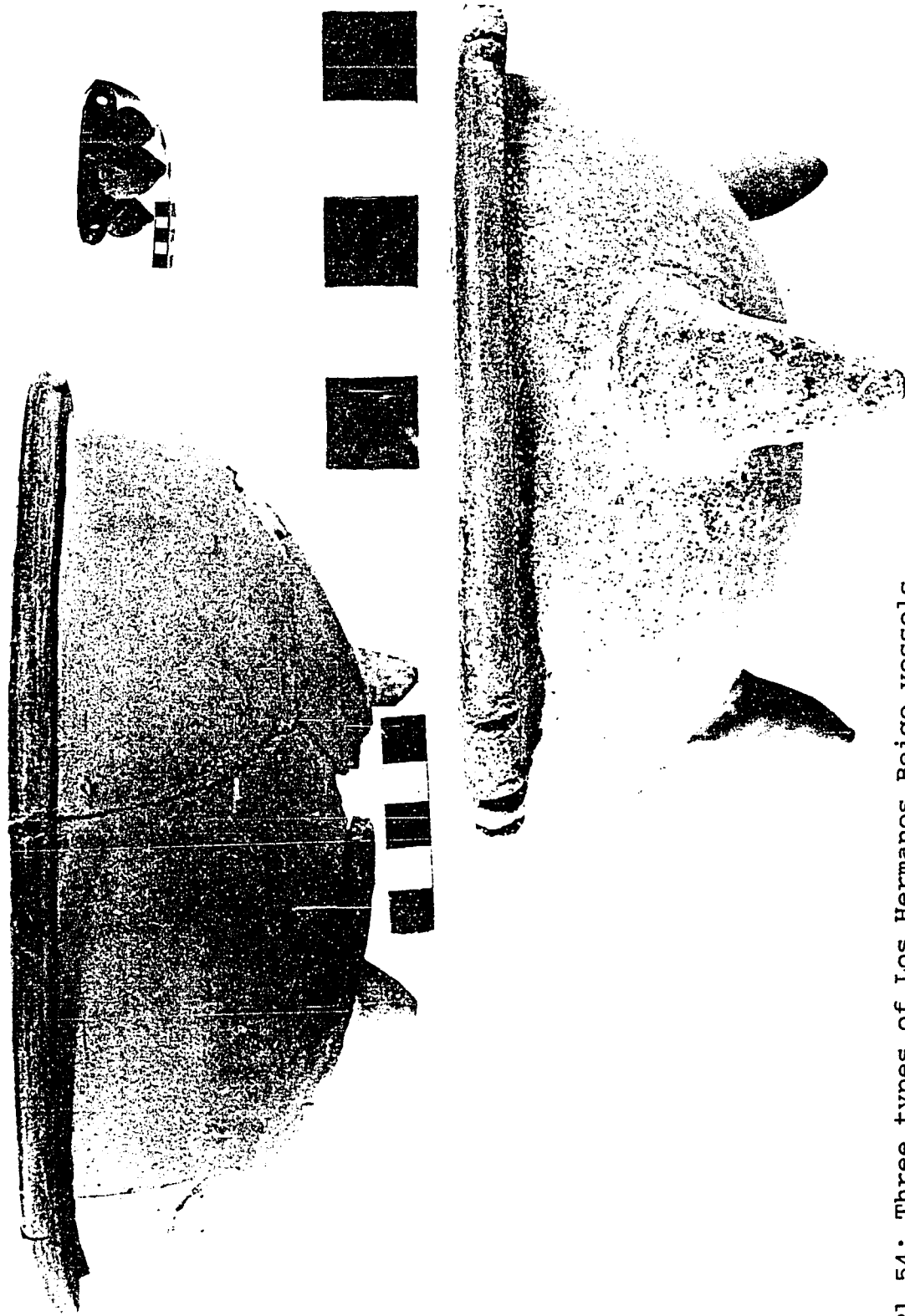

Pl.54: Three types of Los Hermanos Beige vessels.



Pl.55: Los Hermanos Beige ollas, plate, and incensario.

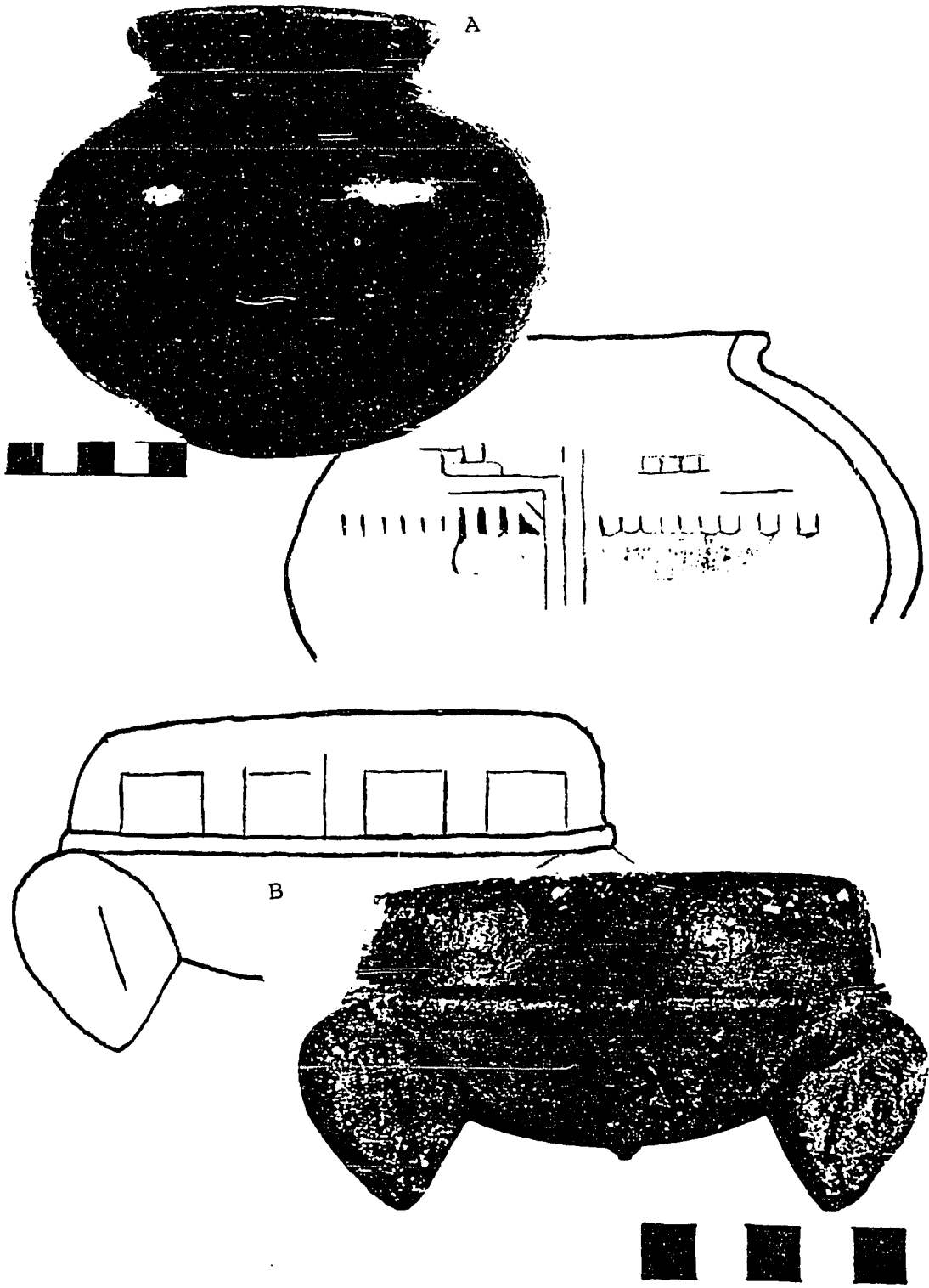

Pl.56: Negative resist technique, black on red ware vessels. A) Art.173, Burials. 51 and 52, infants. B) Art.61, Burial 30, 18 a,b, adult, sex unknown, and two infants.

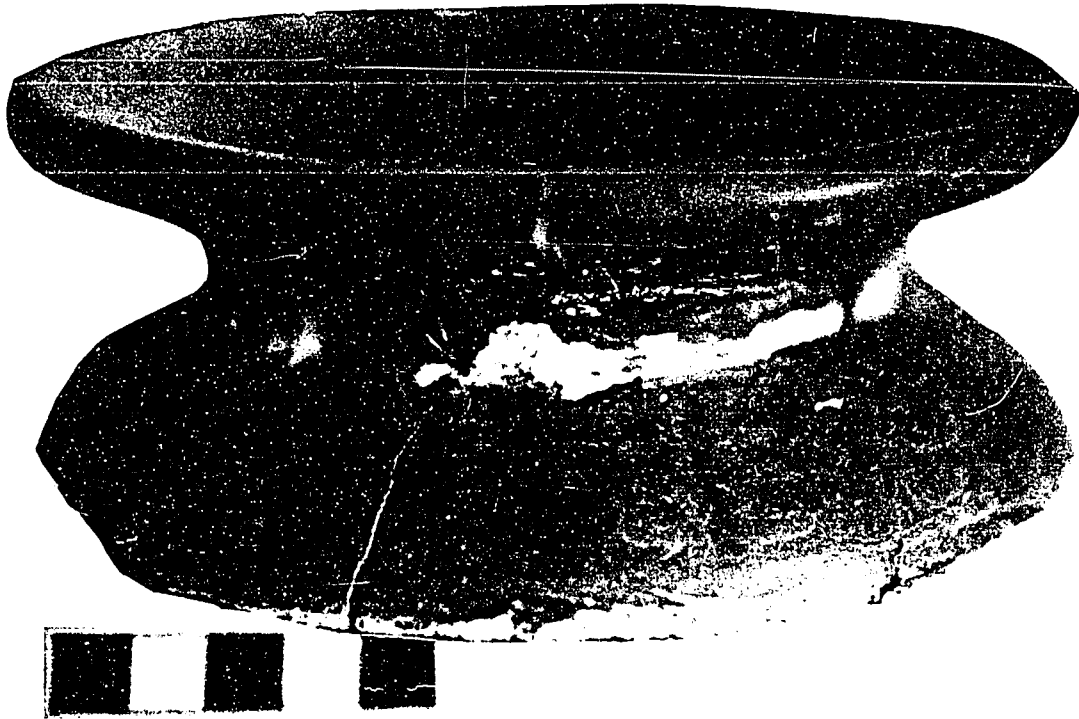

Pl. 57: Negative resist technique, white on red ware.
Art. 340 associate *[illegible]* adult, male?.

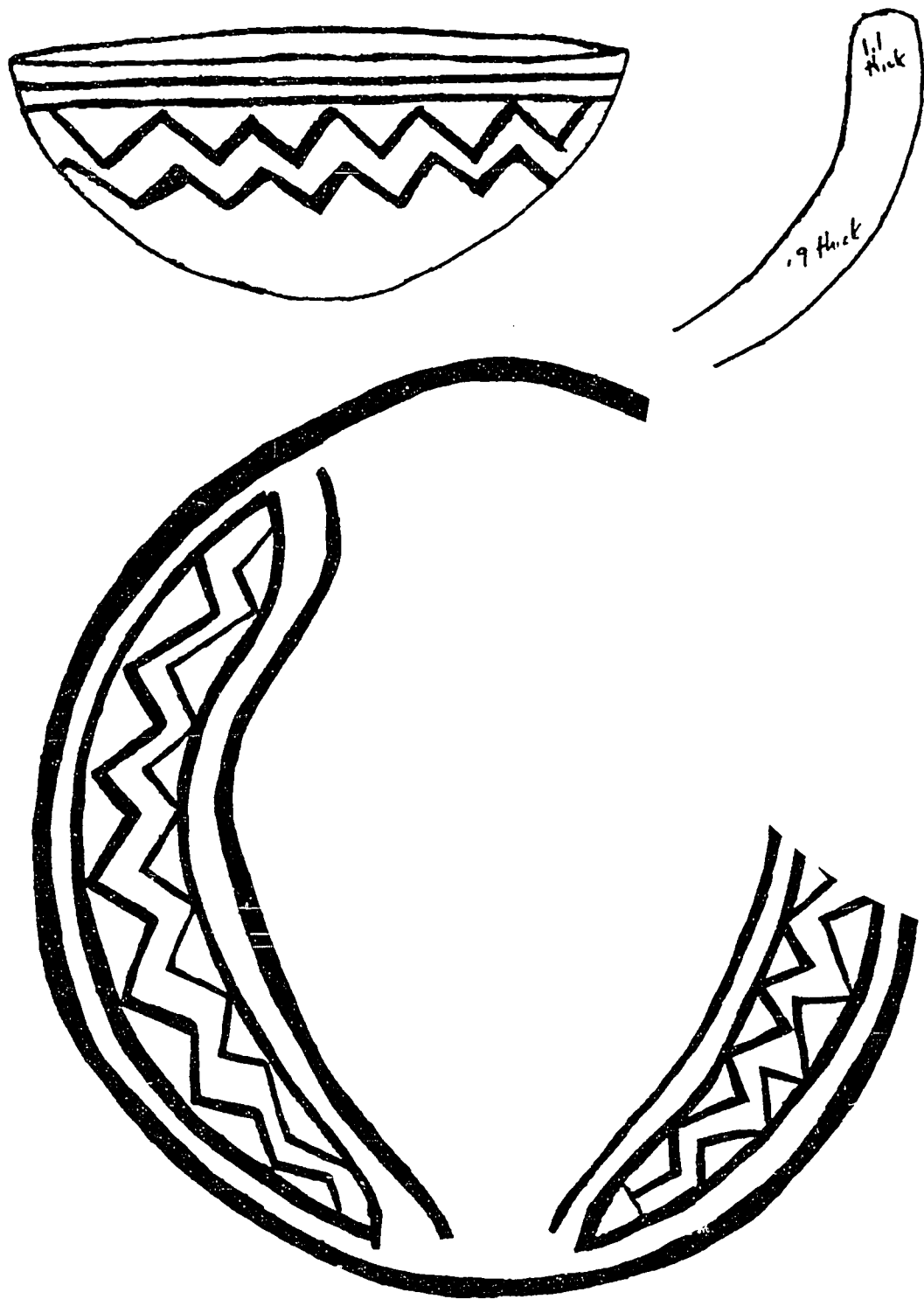

Pl. 58: Charco Red on Black Ware vessel Var. Puerto.

v 1



Pl.59: A) Art.287 Charco: Puerto variety and possibly Cabuyal mix vessel. Associated with Burial 85, young adult, male. B) Charco: Charco variety, lower right, Art.150, applique owl effigy, associated with infants 51 and 52.

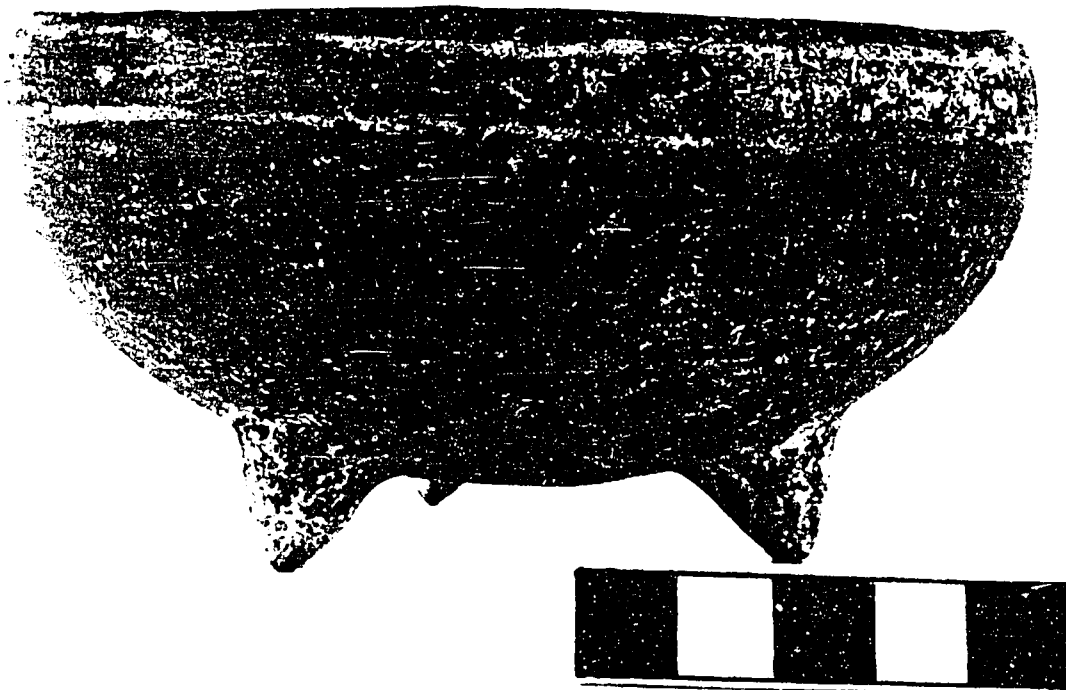
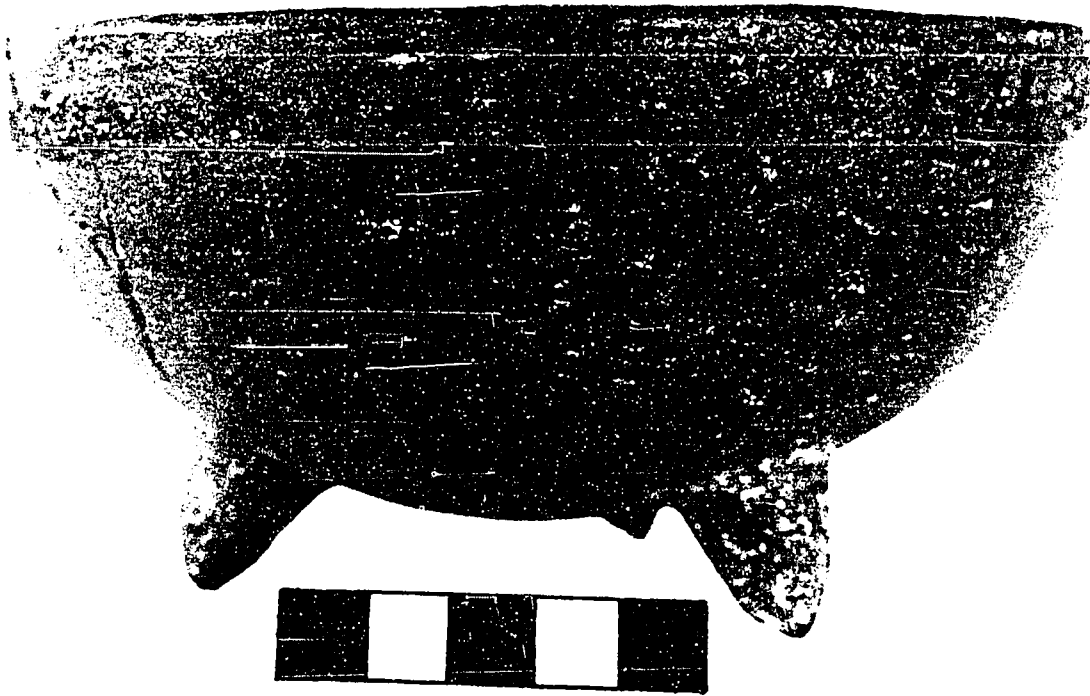

Pl.60: Tola Trichrome vessels.

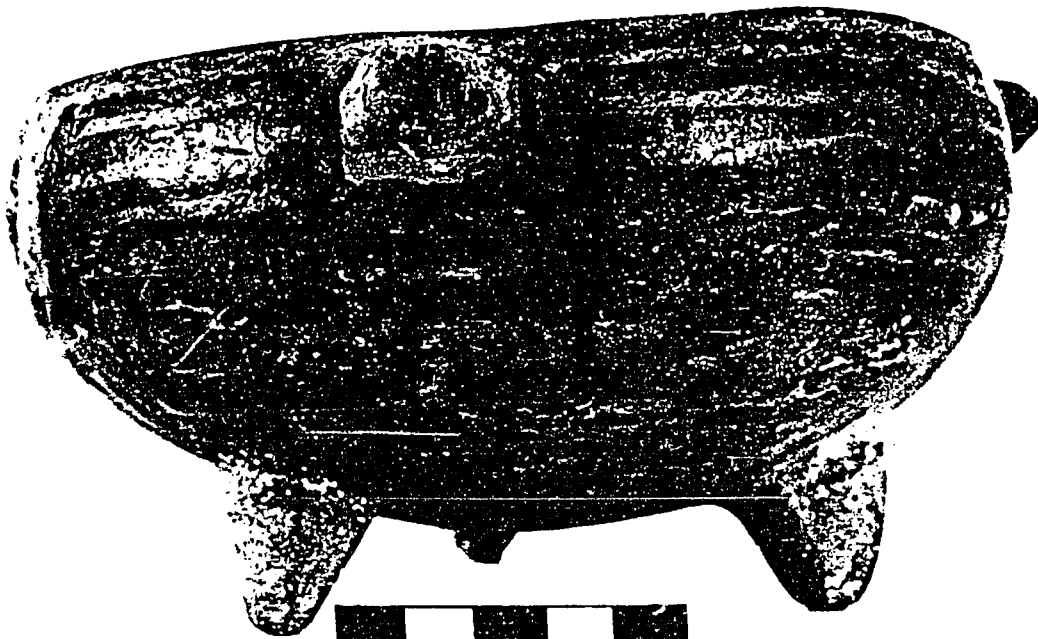
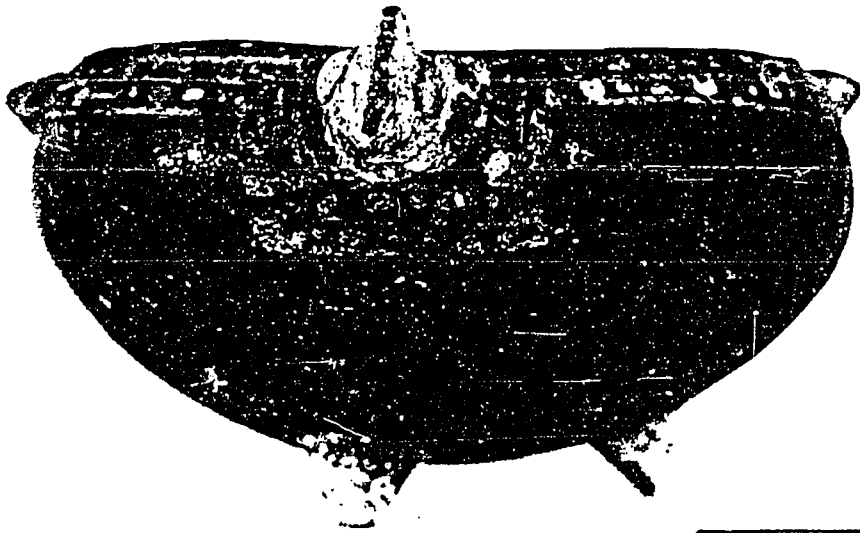

Pl.61: A) Tola effigy vessel, Crax rubra, Art.112, associated with Burial 34, middle adult, female. B) Carrillo effigy vessel, bird, Art. 105, associated with Burial 33, adult, male?.



Pl.62: A) Zelaya Trichrome cuspidor vessel, Art.178, associated with Burial 55, old adult, female. B) Guinea Incised vessel (Art.23).



Pl.63: Guinea Incised vessels with iconographic elements.

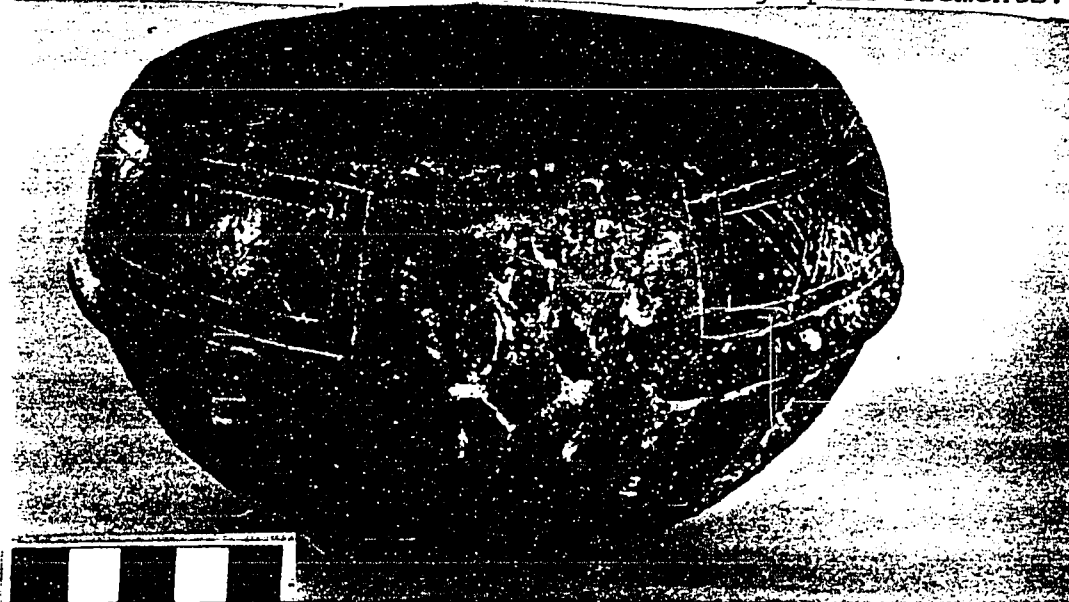

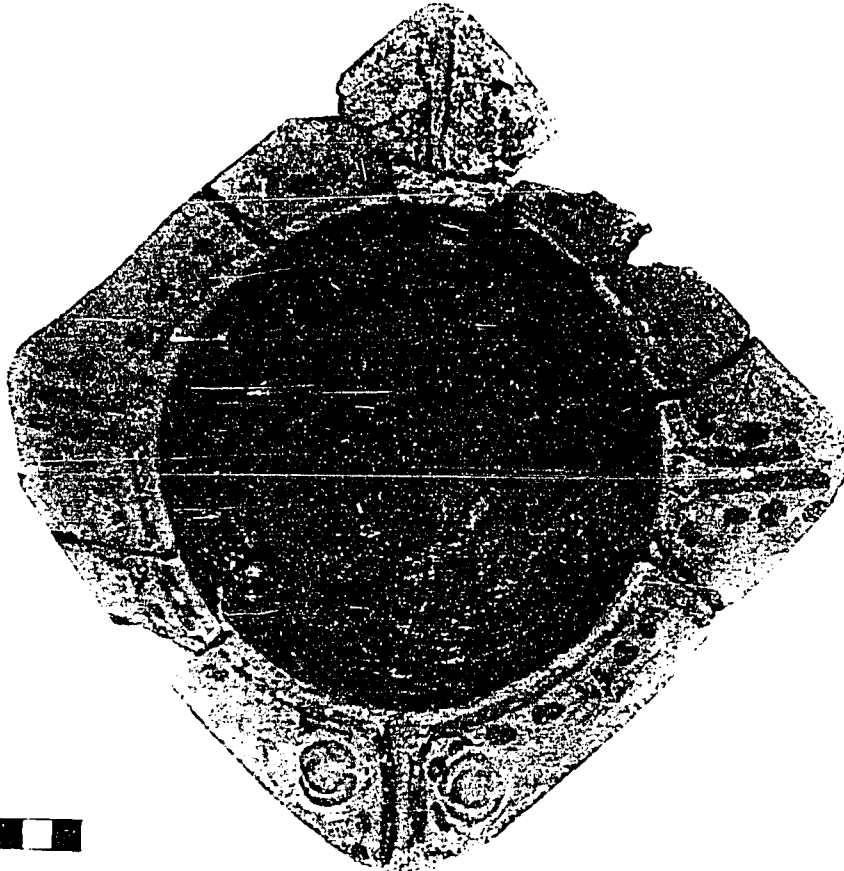
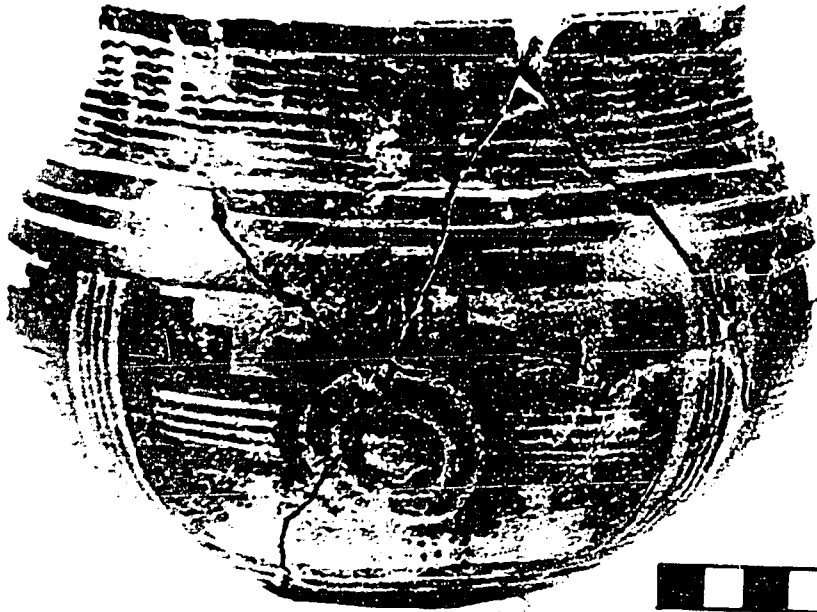

Pl.64: Carrillo vessels. A) Art. 157 associated with Burial 47, an adult, male. B) Art.164, ray effigy capped infant urn Burial 49.

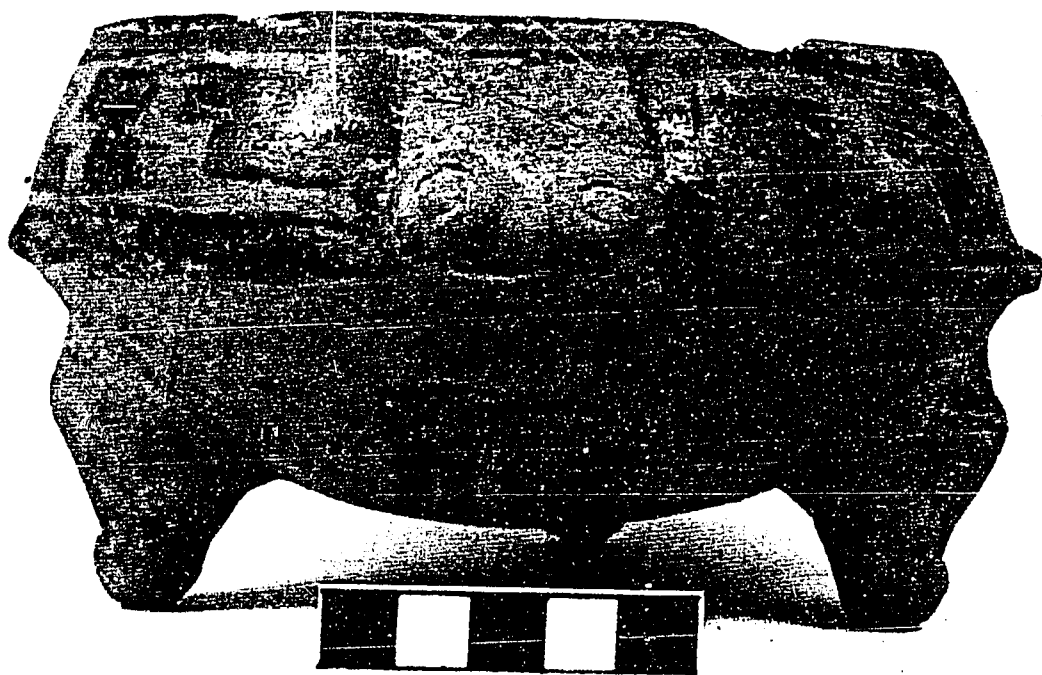

Pl.65: A) Galo vessel (Art.196a) associated with infant Burial 72. B) Chavez Red on Beige vessel placed inside above Galo vessel.



Pl.66: Chavez White on Red effigy support. Art.13, identified as an owl (Tytonidae).

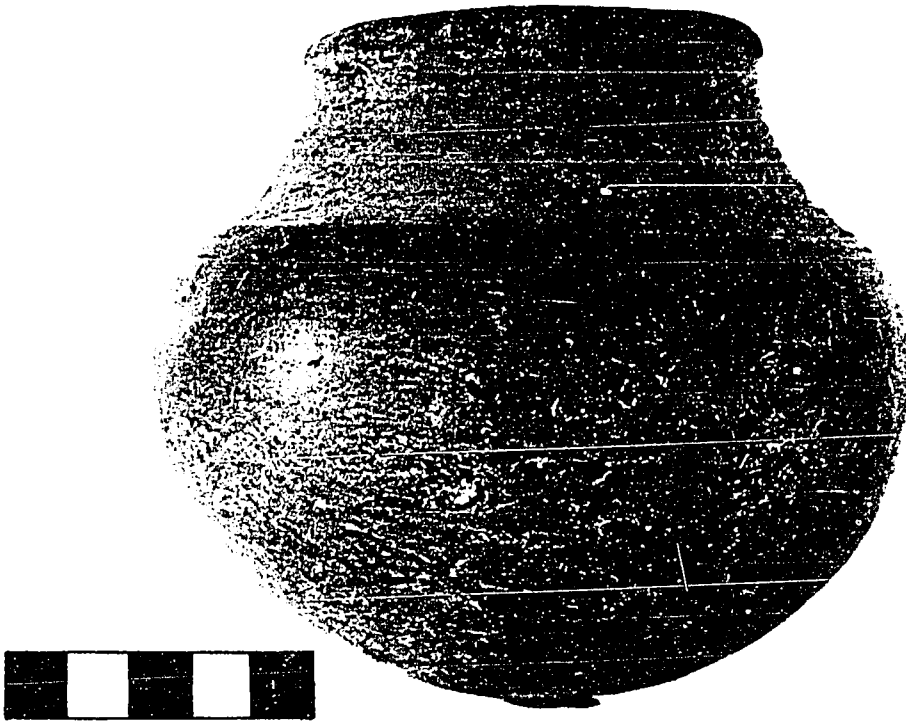

Pl.67: A) Cabuyal vessel. B) Potosi Applique



Pl.68: Mora vessel (Art.35), associated with Burial 9.



Pl.69: Papagayo vessel (Art.113)

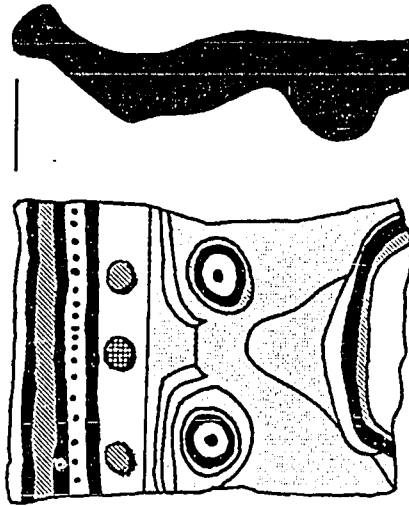

- Orange Painted
- Brown Painted
- White Painted
- Black Painted
- Cream Painted

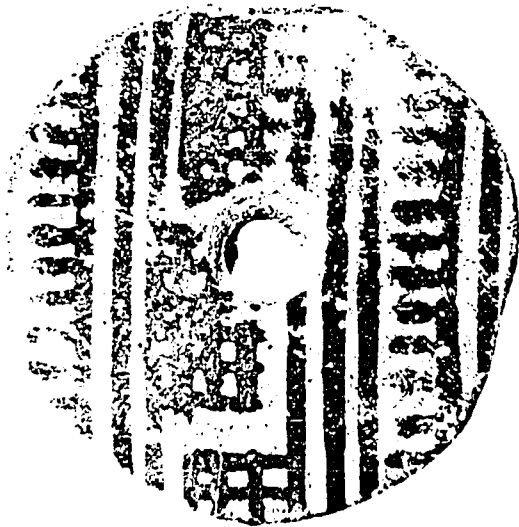

Pl.70:
 A) Mora spindle whorl, Art.38.
 B) Jicote Polychrome vessel,
 C) Luna ware sherd.

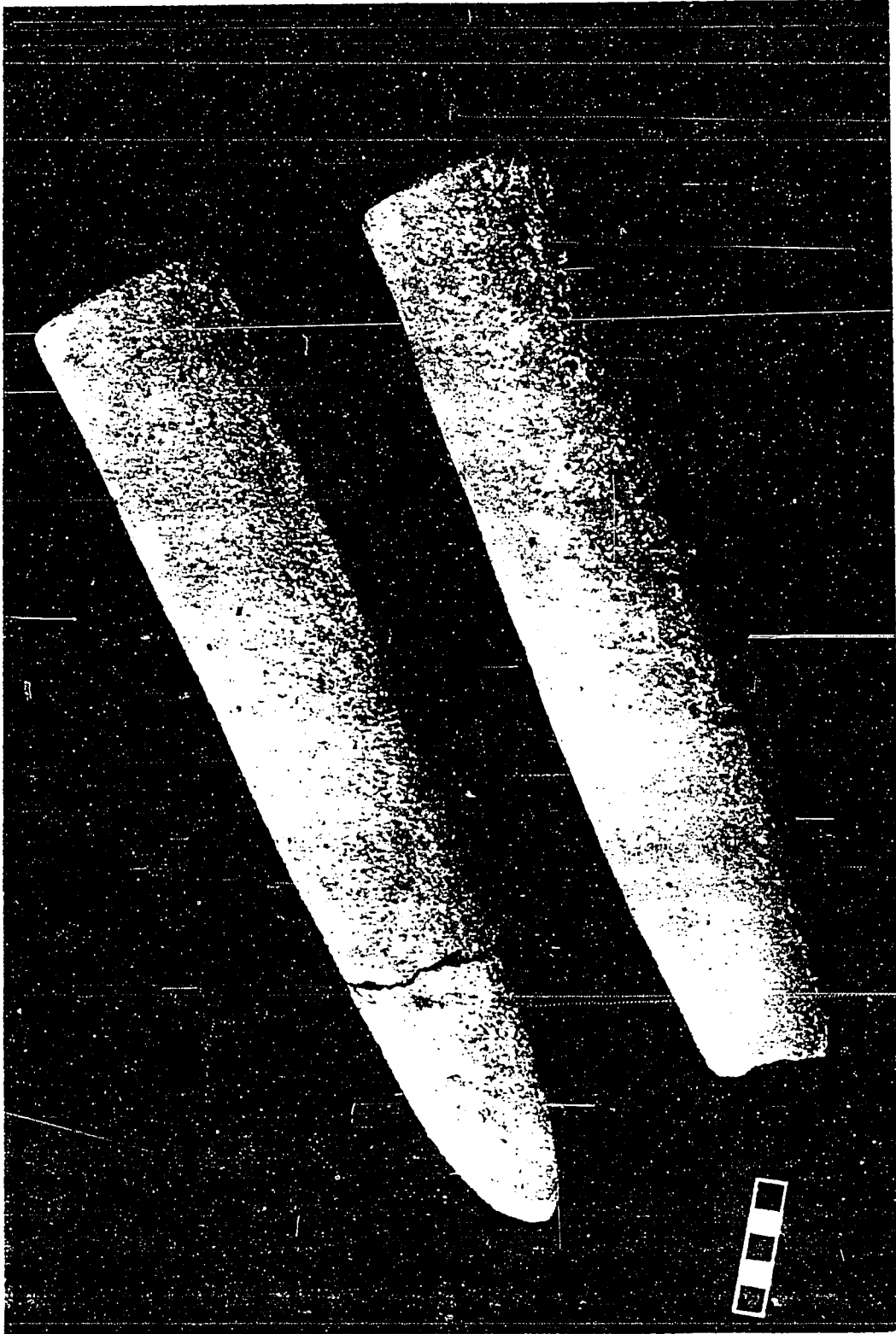

Pl.71: Ceramic cones associated with Burial 31

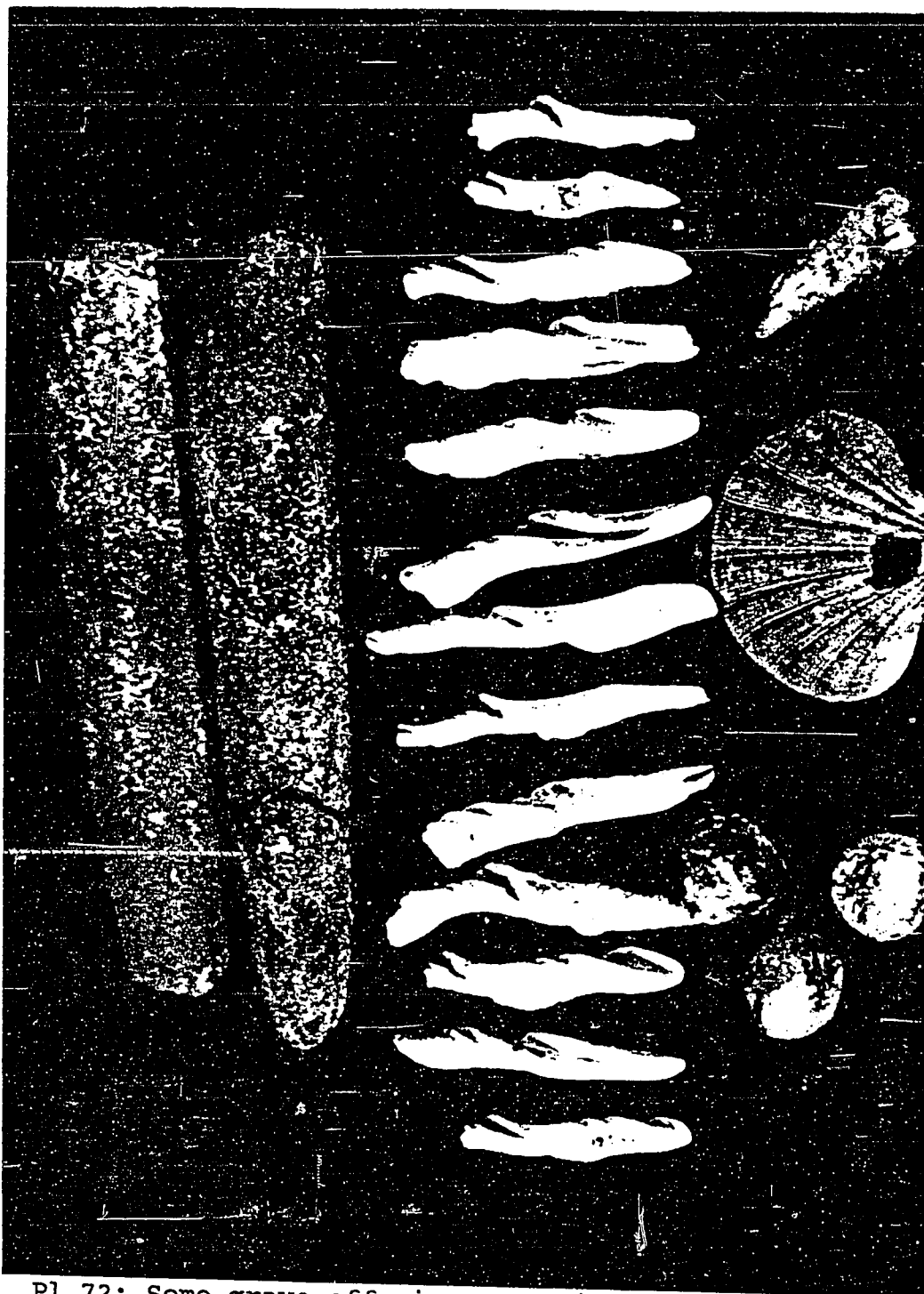

Pl.72: Some grave offerings associated with Burial 31. Ceramic cones, Strombus columella tools, three chert hammerstones, "killed" Lyropecten subnudosis, bone awl.

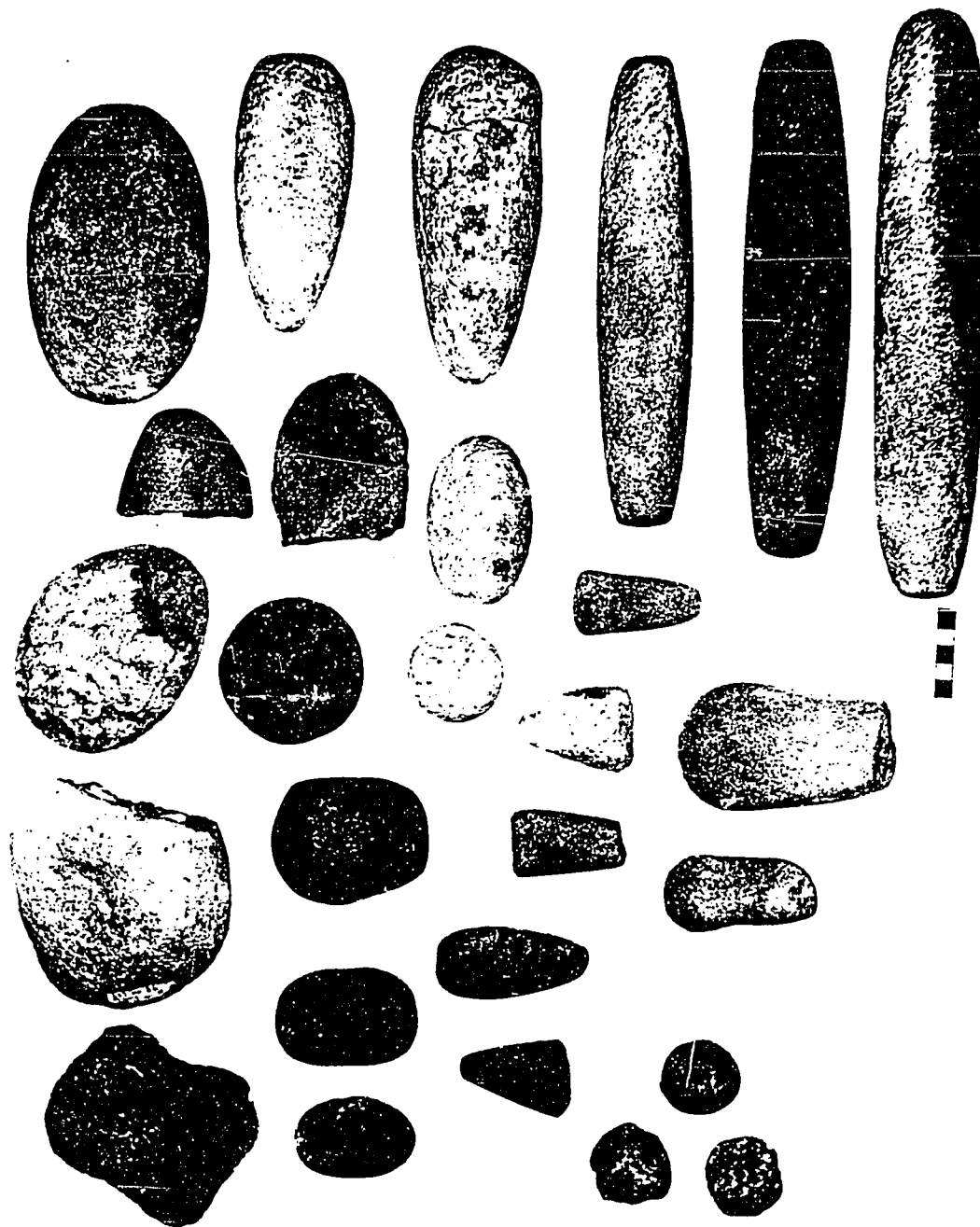

Pl.73: Some representative stone tools of Nacascolo beach cemetery; numbers are catalog artifact numbers.

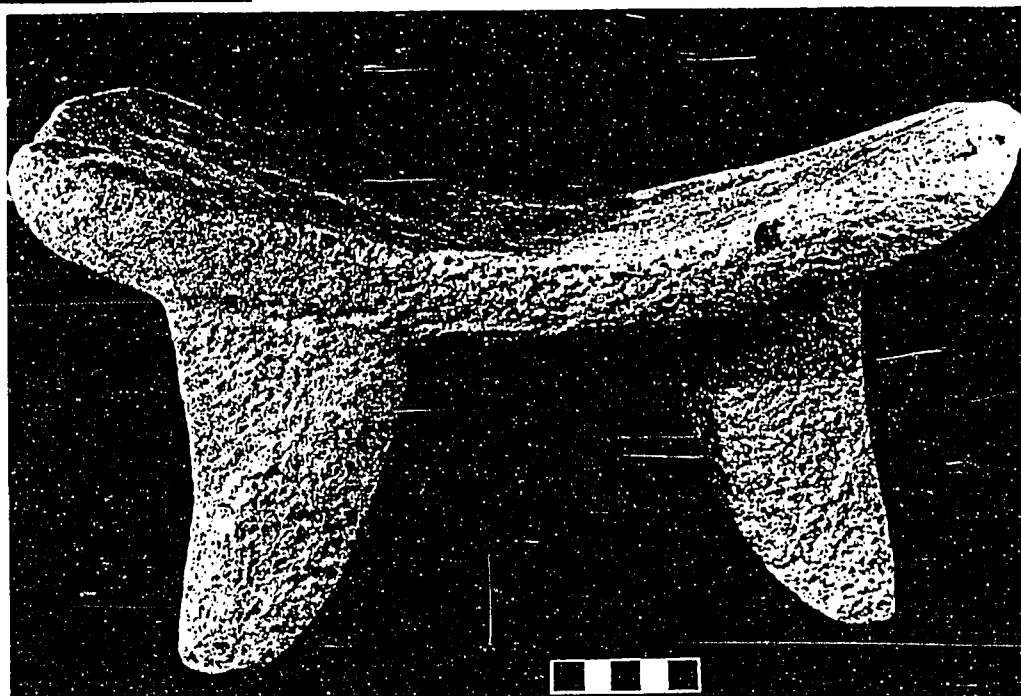
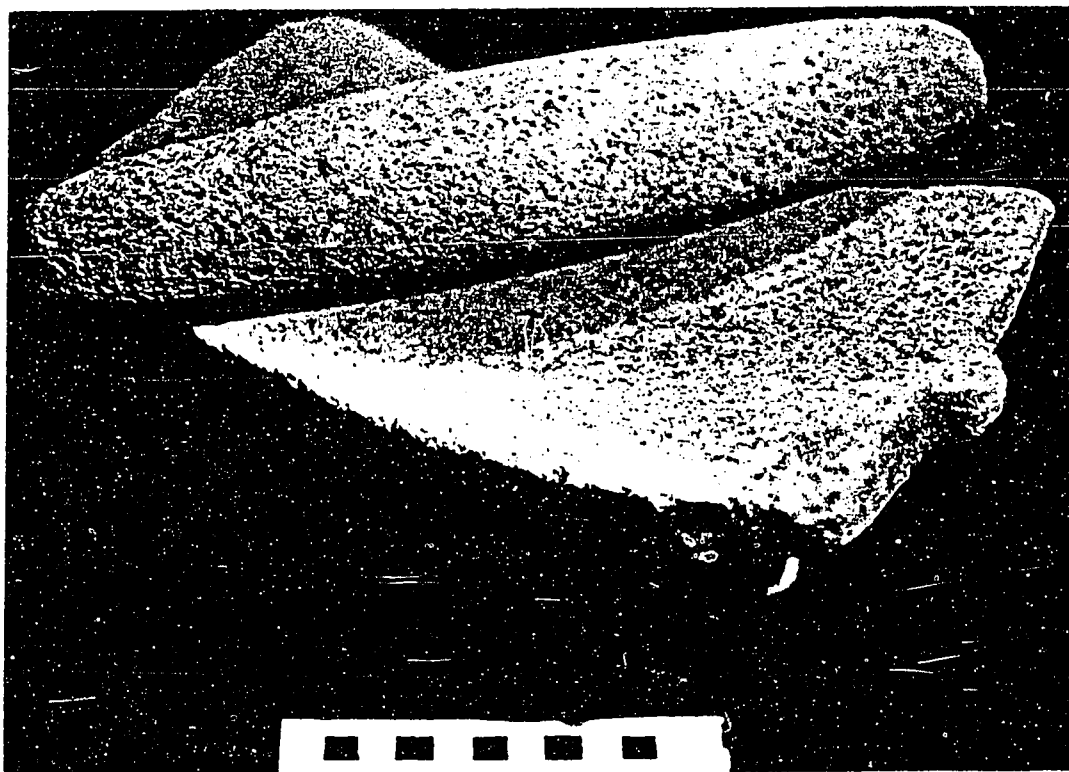

Pl.74: Plain tripod metates from beach cemetery. Top: Arts. 170, 171 associated with infants Burials 51 and 52. Bottom: Art.45 associated with Burial 34.

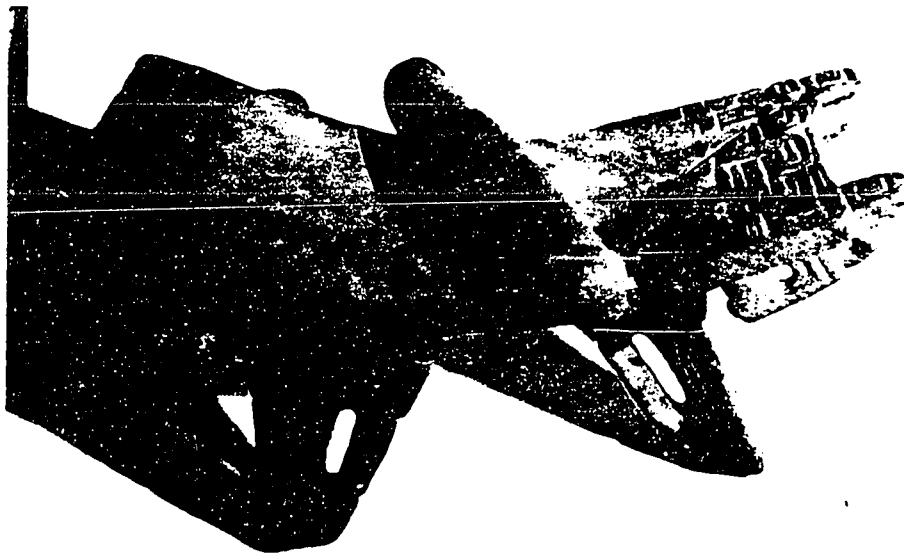

Pl.75: Low relief carved, special purpose metates. Top: associated with cist tomb on Nacascolo hillside. Bottom: Art.110 associated with Burial 34, beach cemetery.

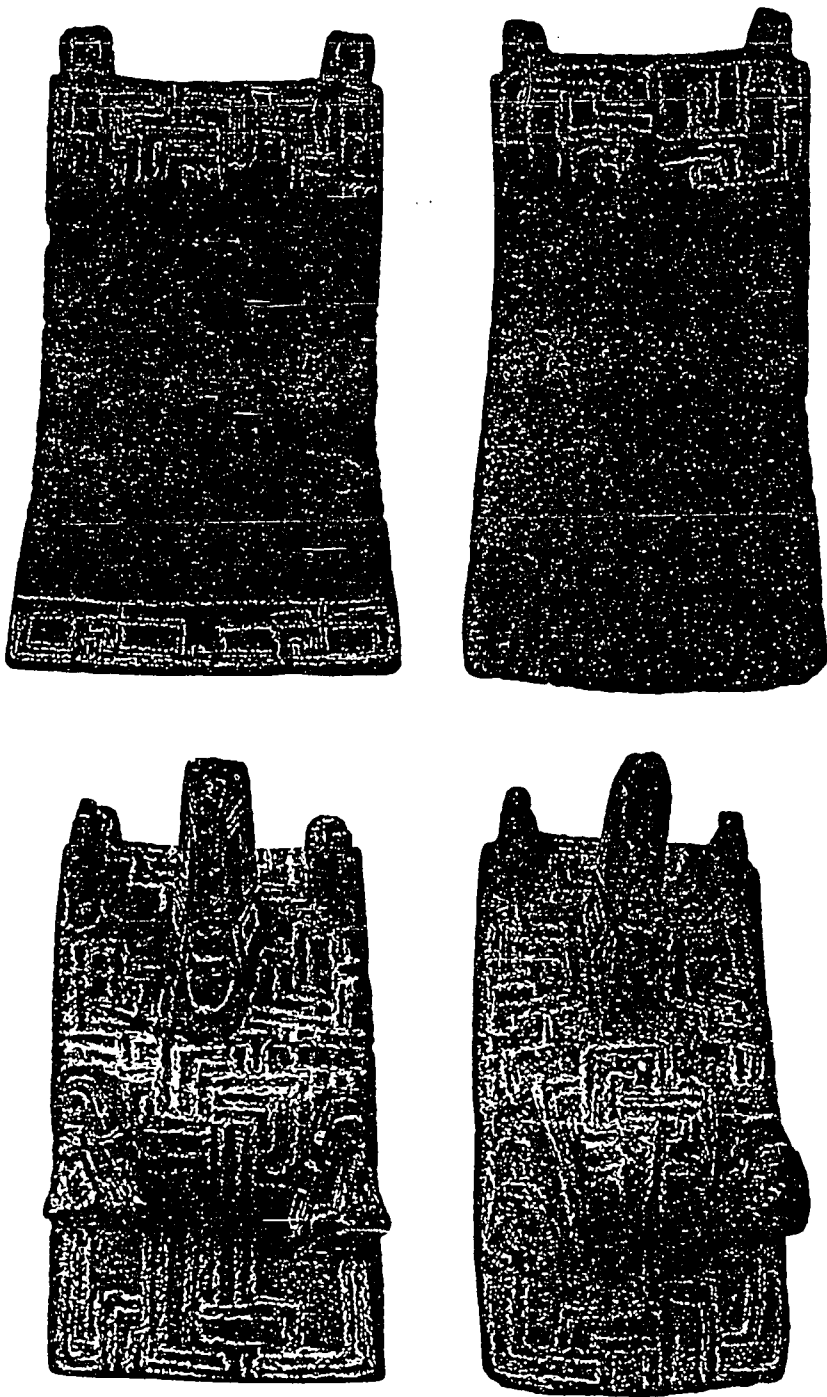

Pl.76: Comparison of geometric designs on low relief carved metates. Left: metate of cist tomb (Op.3a); Right Art.110, Burial 34.

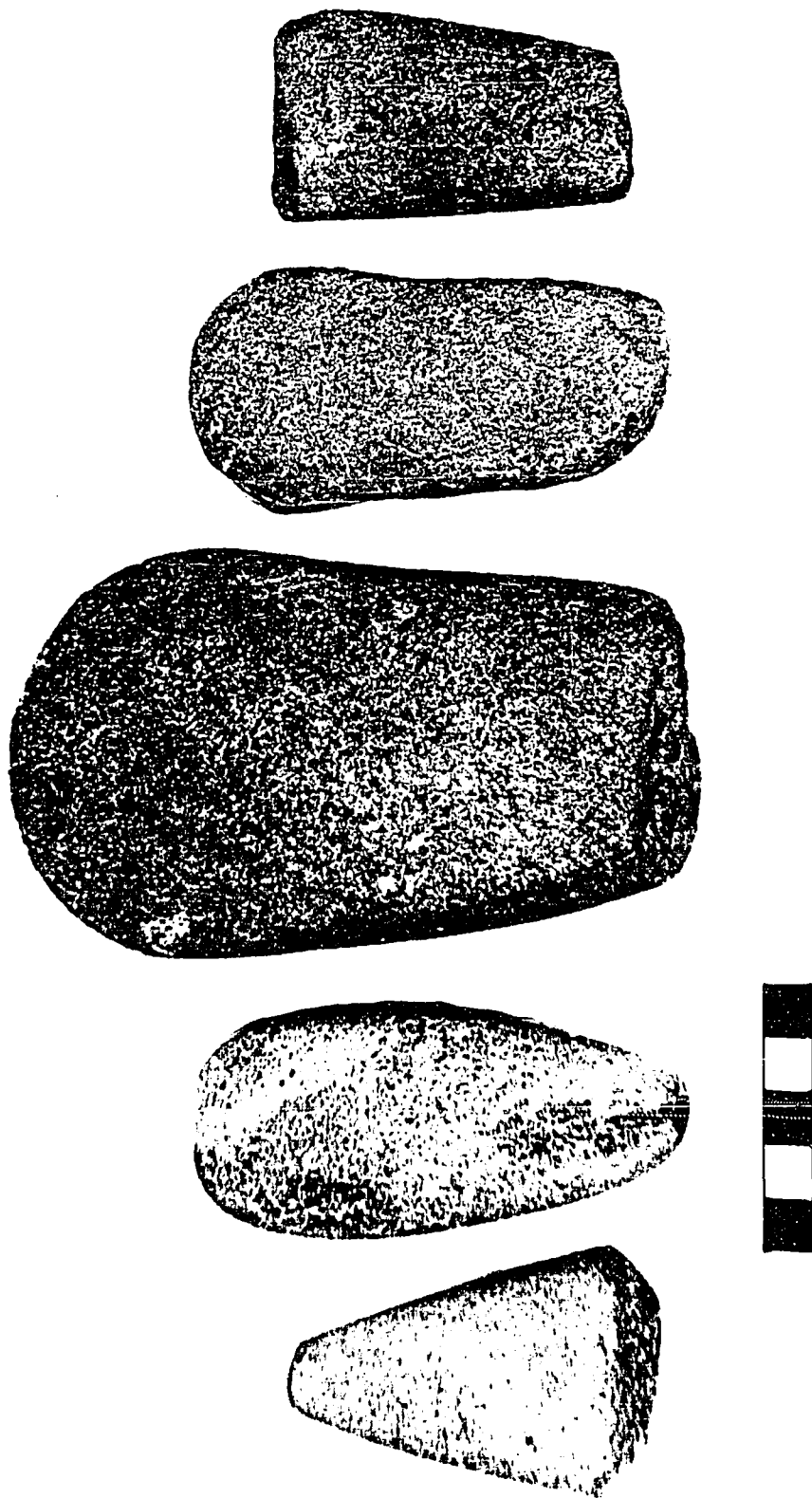

Pl.77: "Celts" of Nacascolo beach cemetery; a) 8A 0-20, b) Art.360, c) Art.135, d) Art.204, e) 8e 40-60.

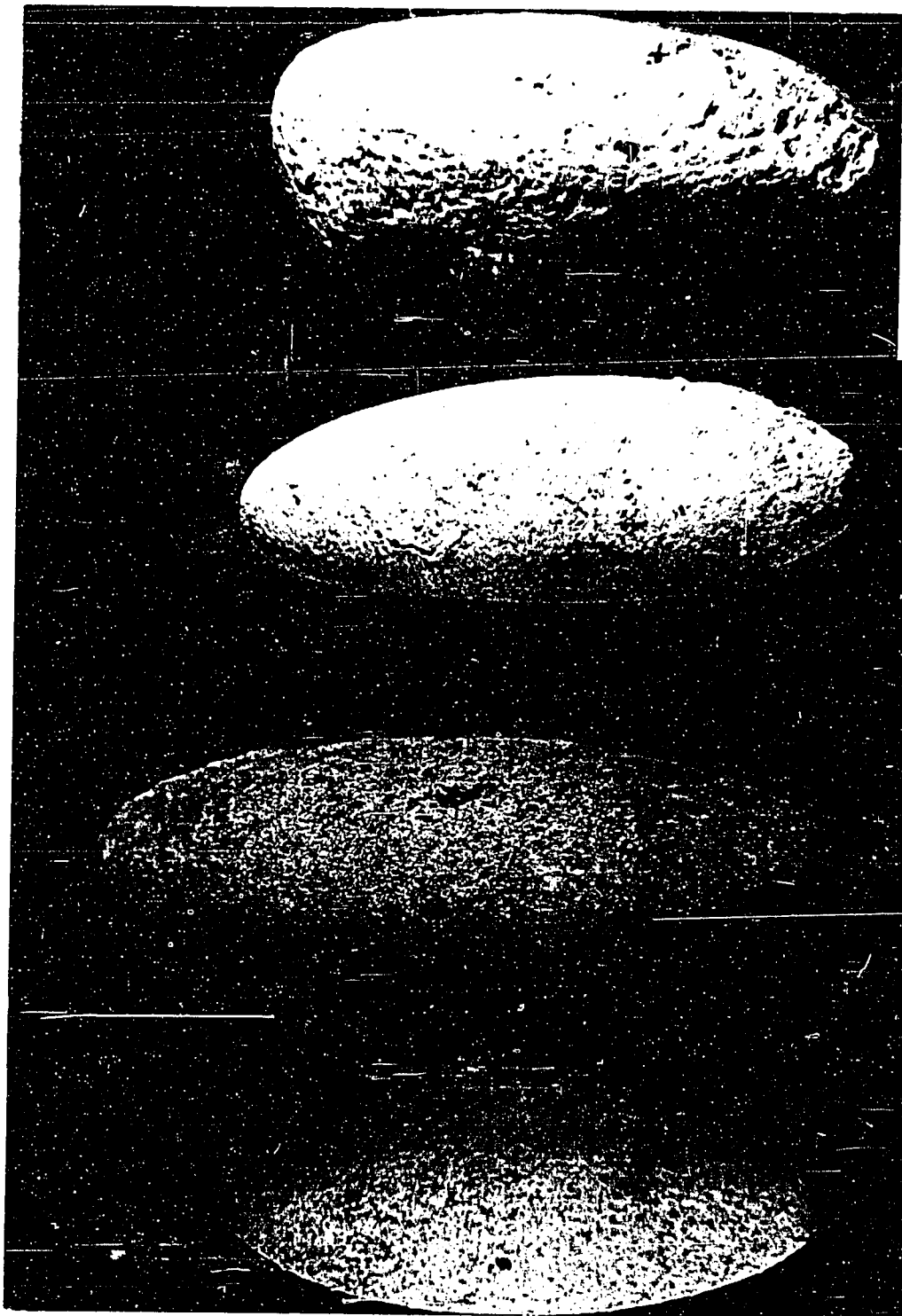

Pl.78: Pestles type 2 and 3; a) Art.202, b) Art.203, c) Art.201, d) Art. 233.

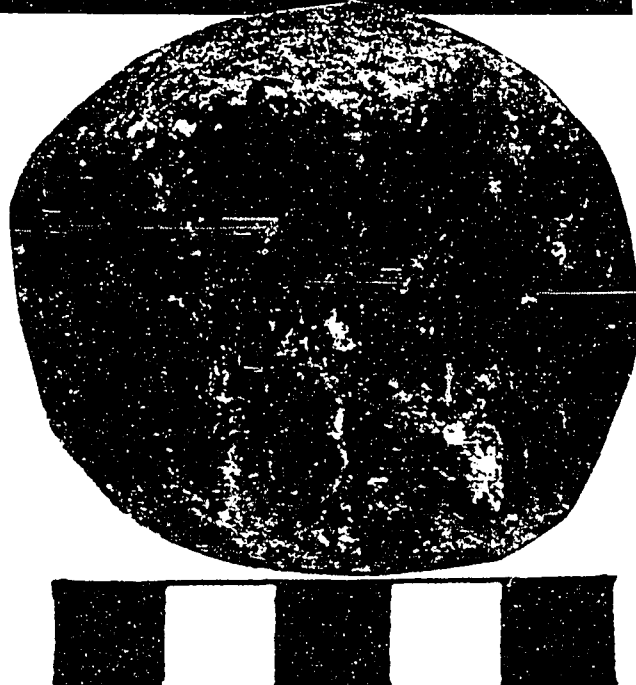
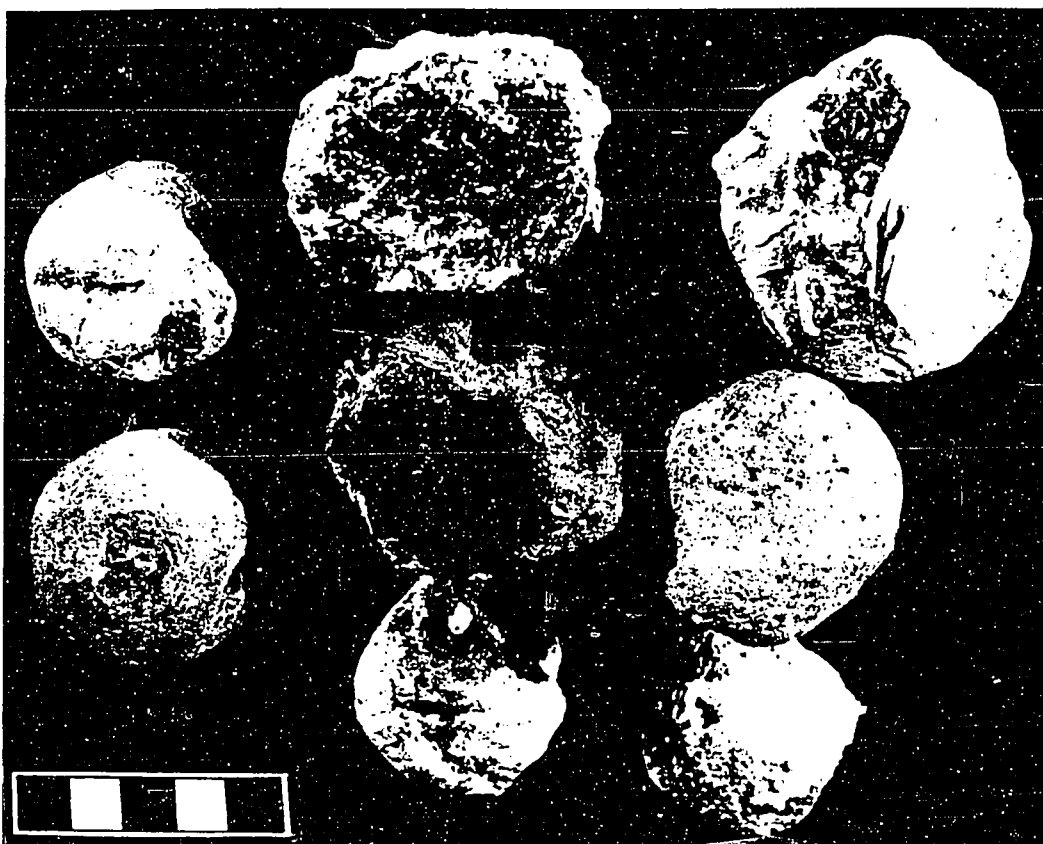

Pl.79: Top: Hammerstones associated with Burial 57
Bottom: One of three chert hammerstones associated with Burial 31.



Pl.80: Top: Abraders or whetstones associated with Burials 11 and 34. Below: Enigmatic stone, Art.126, left view shows percussion wear and right view shows indentation with white paint, possible palate.

Pl.81: Small stones, some "nutting" some enigmatic.

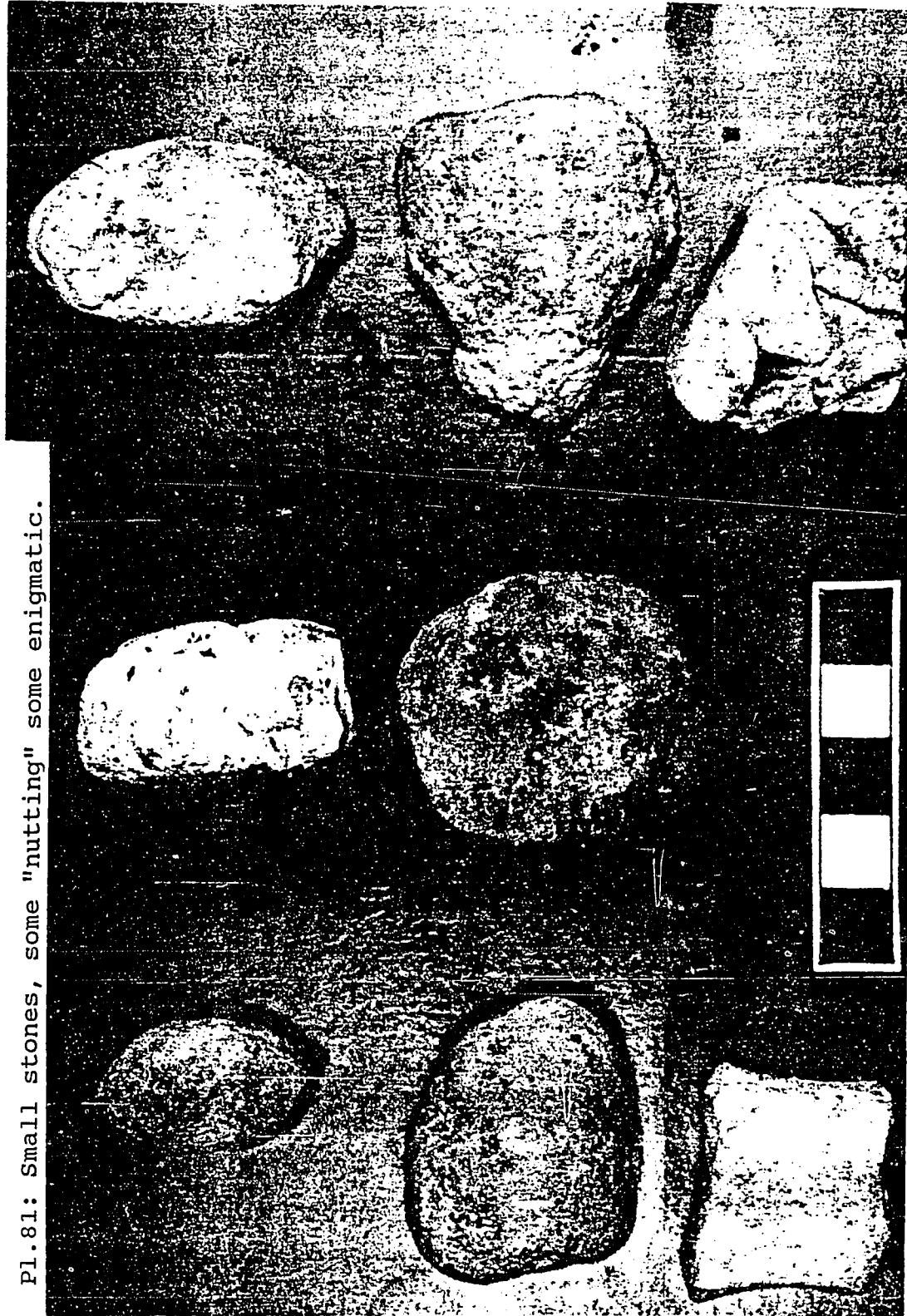

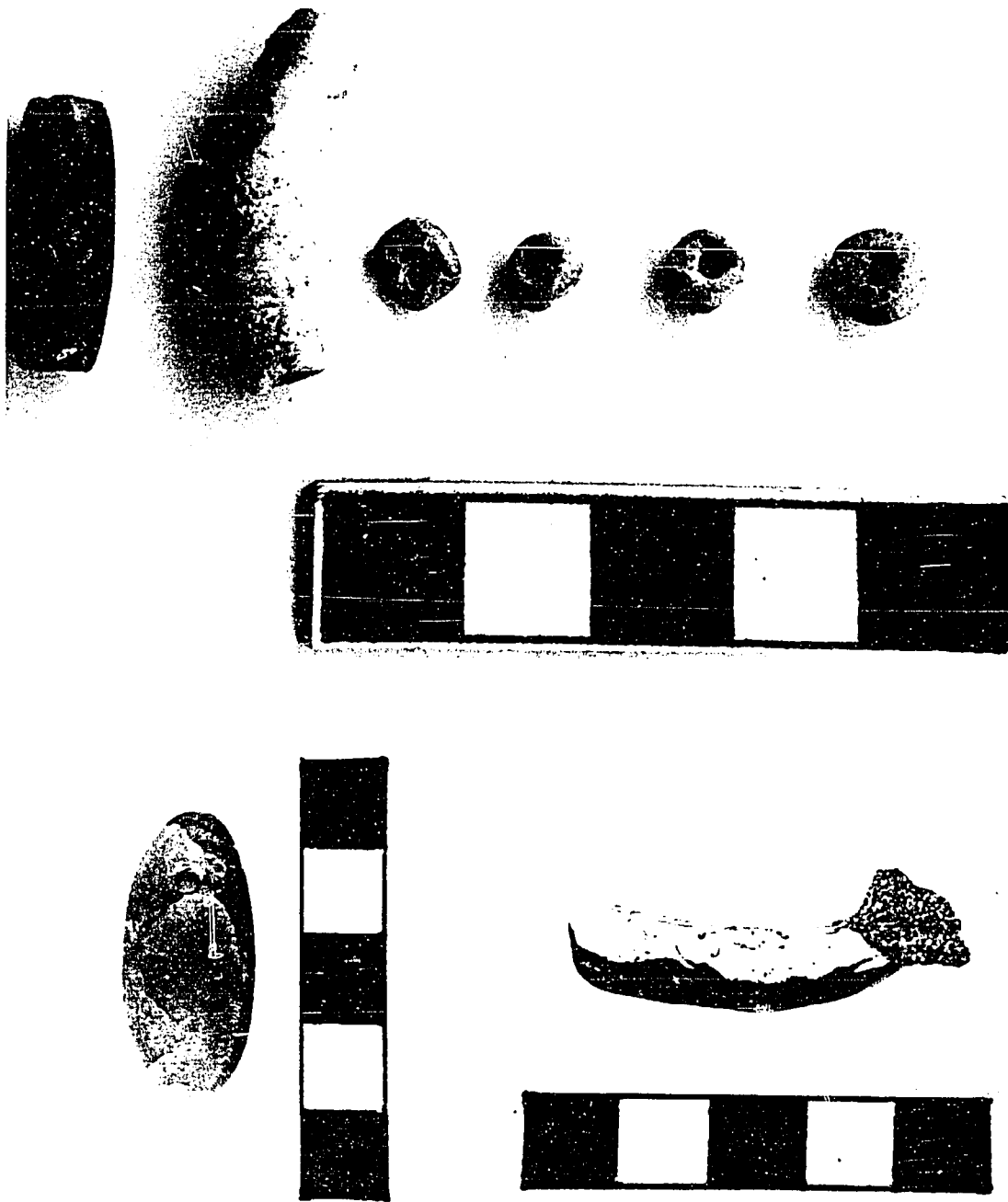

Pl.82: Top: Tubular jade (greenstone) bead (Art.167) associated with infant burials, coral beads (Arts.185-189); Bottom left: jade pendant associated with Burial 108; Right: shell, possible pendant.

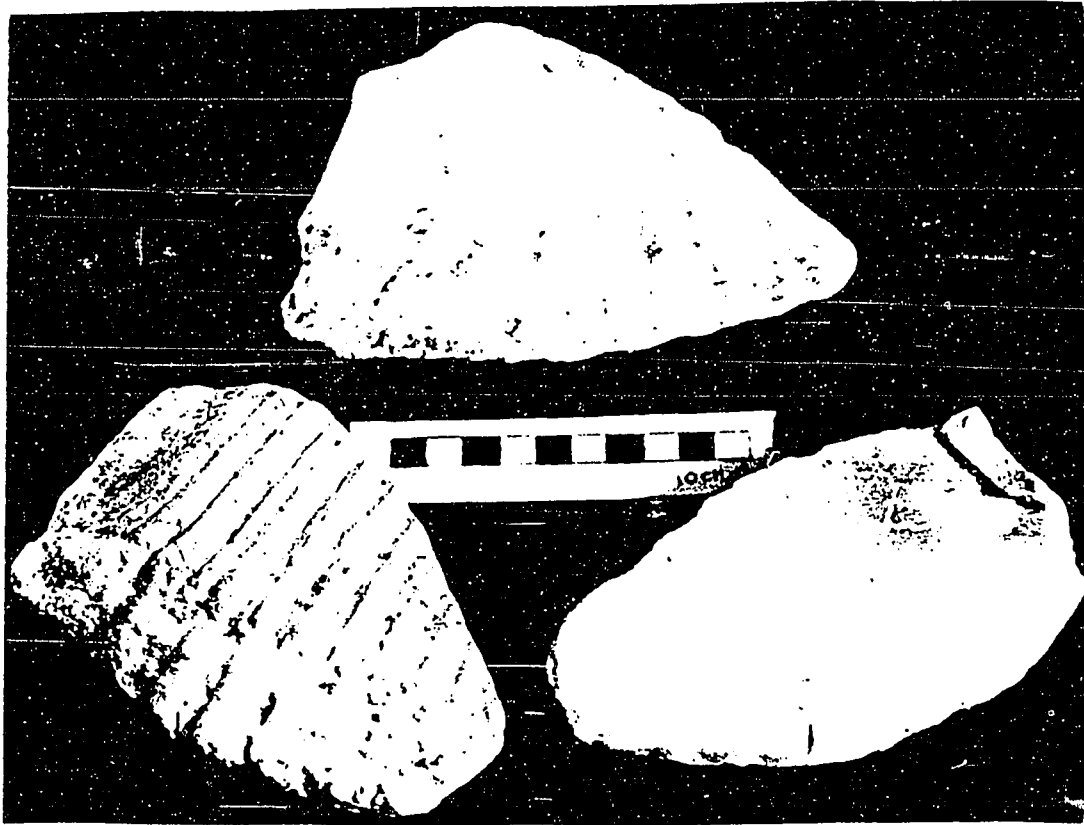

Pl.83: Strombus flange and columella tools.

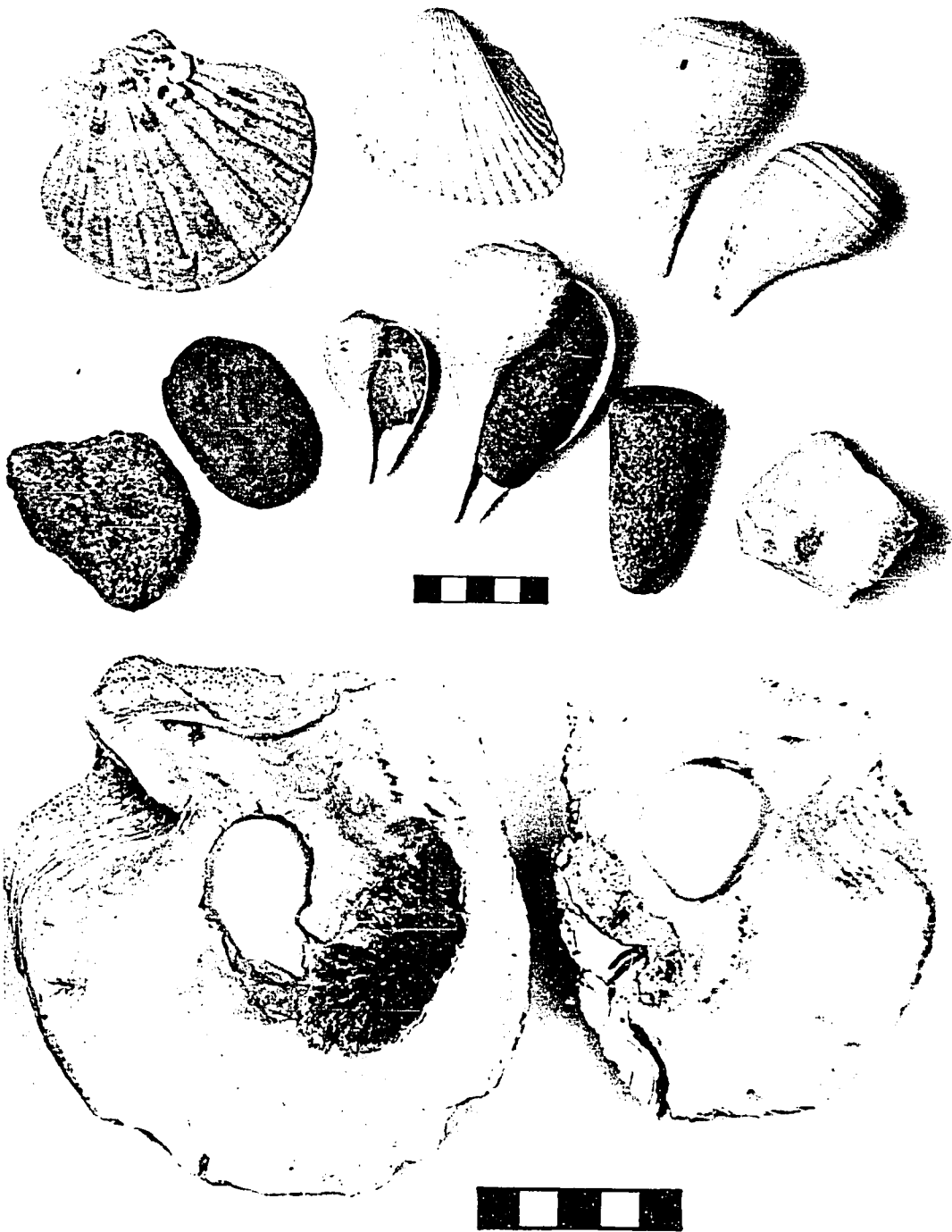

Pl.84: Top: Tools made of Ficus ventricosa associated with Burial 104. Notice pestle placed inside one of them; Below: Modified Ostrea.

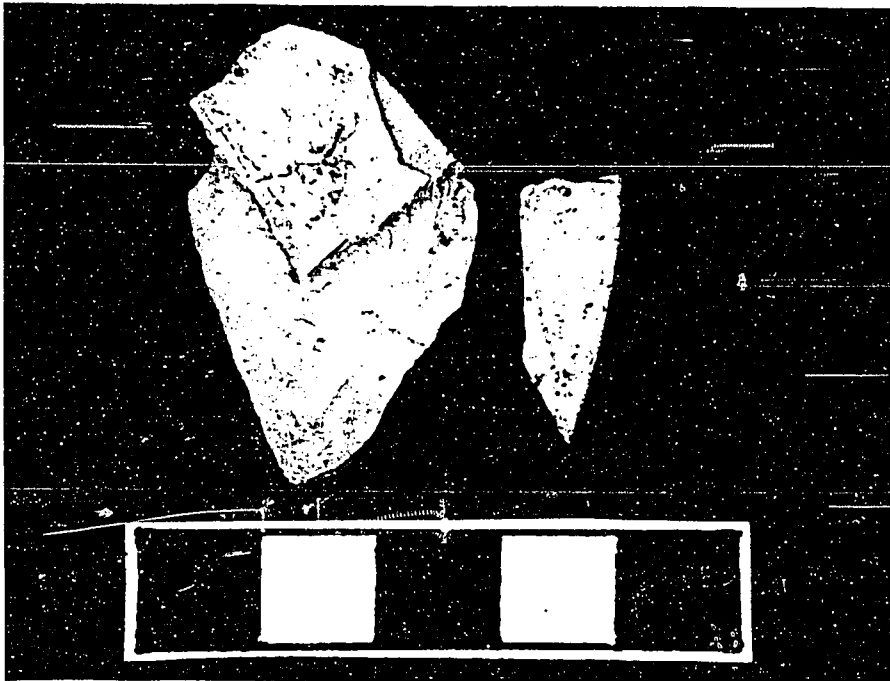
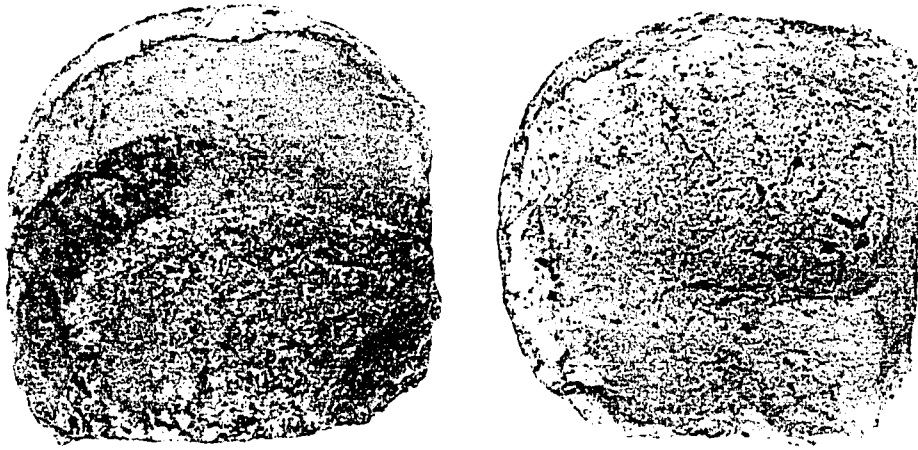

Pl.85: Top: Modified fossilized shell, possible palate (Art.305) associated with Burial 85. Below: Modified shell associated with Feature 18, left, scraper; right, possible awl.



Pl.86: Top: Human humeri tubes; above covered with calcium concretions, below tubes cleaned and separated (Art.220, Burial 66); Middle: bone awl (Art.92a, Burial 31); Bottom right: shark (cf. *Careharhinidae*) vertebra bead, (Art.191, Burial 44).

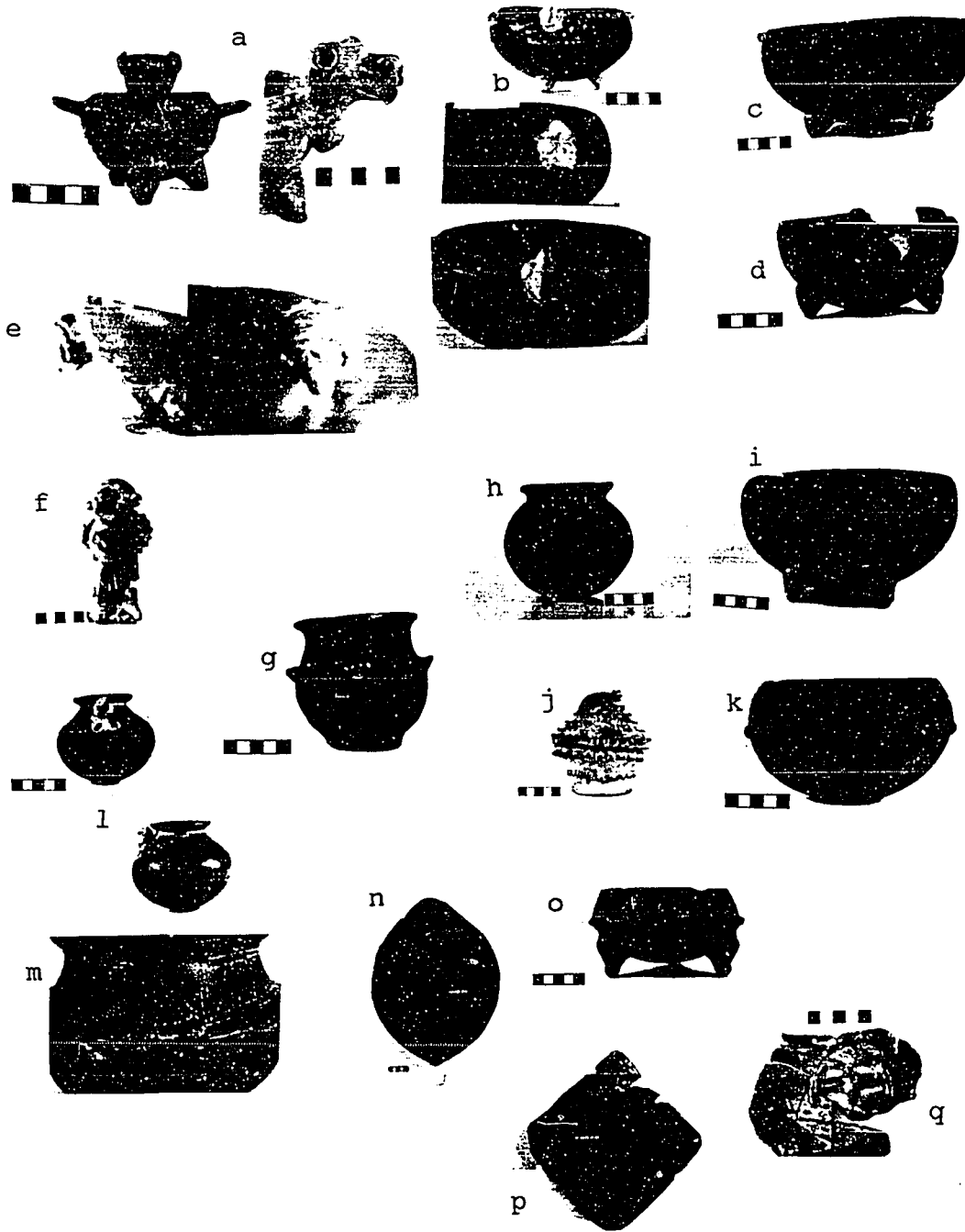

Pl.87: Iconography of some of the Nacascolo beach cemetery ceramics. a) Frigate (Art.5); b) Currasow (112); c and d) bird (145, 255); e and f) owl (333, 13); g) bat (115); h) armadillo (90); i) pisote (194); j) feline (209); k) unidentified mammal (224); l and m) turtle (150, 88); n and o) lenguado (64, 196a); p) ray (164); q) human (31).



Pl.88: Cist tombs from Guayabo de Turrialba



Pl.89: Elite burial from Barrial de Heredia, Central Valley.



a

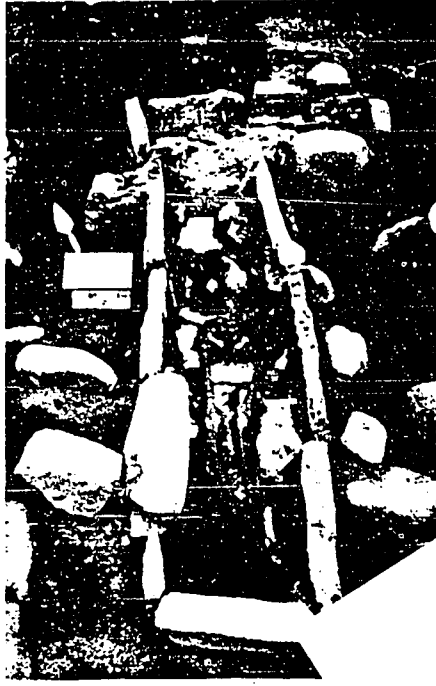

b



Pl. 90 Cist tombs from Cartago and Atlantic watershed,
Severo Ledesma Site.